

CATALOG

SACE Tmax XT UL/CSA

Low voltage molded case circuit-breakers
UL489 and CSA CS22.2 Standards



Break new ground

- Data and connectivity
- Ease of use and installation
- Performance and protection
- Safety and reliability

Break new ground.

A cutting-edge molded case circuit-breaker range delivering a brand new product experience, with extreme performance and protection features up to 1200A, maximizing ease of use, integration and connectivity. Built to deliver safety, reliability and quality.



SACE Tmax XT

The complete offering

MAIN
CHARACTERISTICS

01

THE RANGES

02

PROTECTION
TRIP UNITS

03

COMMUNICATION AND
CONNECTIVITY

04

ENERGY
MEASUREMENTS

05

SOLUTIONS

06

ACCESSORIES

07

ORDERING CODES

08

Main characteristics

1/2 SACE Tmax XT overview

1/4 Distinctive features

Products conformity

1/12 Compliance with Standards

1/13 Company quality system

1/13 Environmental Health & Safety Management System, Social Responsibility and Ethics

1/13 Product Material Compliance

Construction characteristics

1/14 Double insulation

1/14 Positive operation

1/14 Insulation behaviour

1/14 Tropicalization

SACE Tmax XT overview

Break new ground

Break new ground simply means delivering value through the entire customer journey by leaving behind the traditional concept of circuit-breaker. The SACE Tmax XT range offers a unique customer experience that, sharing the same features and logics with the Emax 2 range, for the first time ever overcomes the differences between molded case and air circuit-breakers. The most advanced products designed to maximize data and connectivity, ease of use and installation, performance and protection, safety and reliability.

The SACE Tmax XT range offers higher performance, better protection and more precise metering than equivalent units, and can handle from 160 up to 1200A.

Combined with the world's most precise electronic trip units in the smallest frames, the new range delivers significant time savings and enhances installation quality.

Reliability is further increased, and speed of installation reduced, thanks to Bluetooth and Ekip connectivity for mobile devices.



The SACE Tmax XT family's built-in connectivity links smartphones, tablets and PCs to data analysis tools on the ABB Ability™ cloud platform in real time. The extreme precision of the data measured means users have access to accurate information anywhere and anytime, making it easier to monitor resources and identify savings opportunities. Using the embedded smart power controller can help reduce energy consumption by up to 20 per cent.

Upgrading the breakers is straightforward: for the first time, customers can download new functions from ABB Ability Marketplace™, choosing among more than 50 different protection, metering and automation functionalities.



Distinctive features

Data and connectivity



Plant management of the future – SACE Tmax XT sets standards in modern plant and energy management. Access, monitor and control information remotely, anywhere, at any time. Improving efficiency and saving energy.



The SACE Tmax XT is the first molded case circuit-breaker to become an active element inside the electrical plant without using external accessories.

Local connection

Commissioning and device setting have never been so easy thanks to the Bluetooth connectivity and the Ekip Connect software.

Remote communication

All the data of the electrical plant are accessible and the interaction with the breakers from remote is straightforward thanks to the several communication protocols available.

Cloud connectivity

Cloud connection is now possible to exploit the full service of ABB Ability™ EDCS thanks to the Ekip Com HUB.

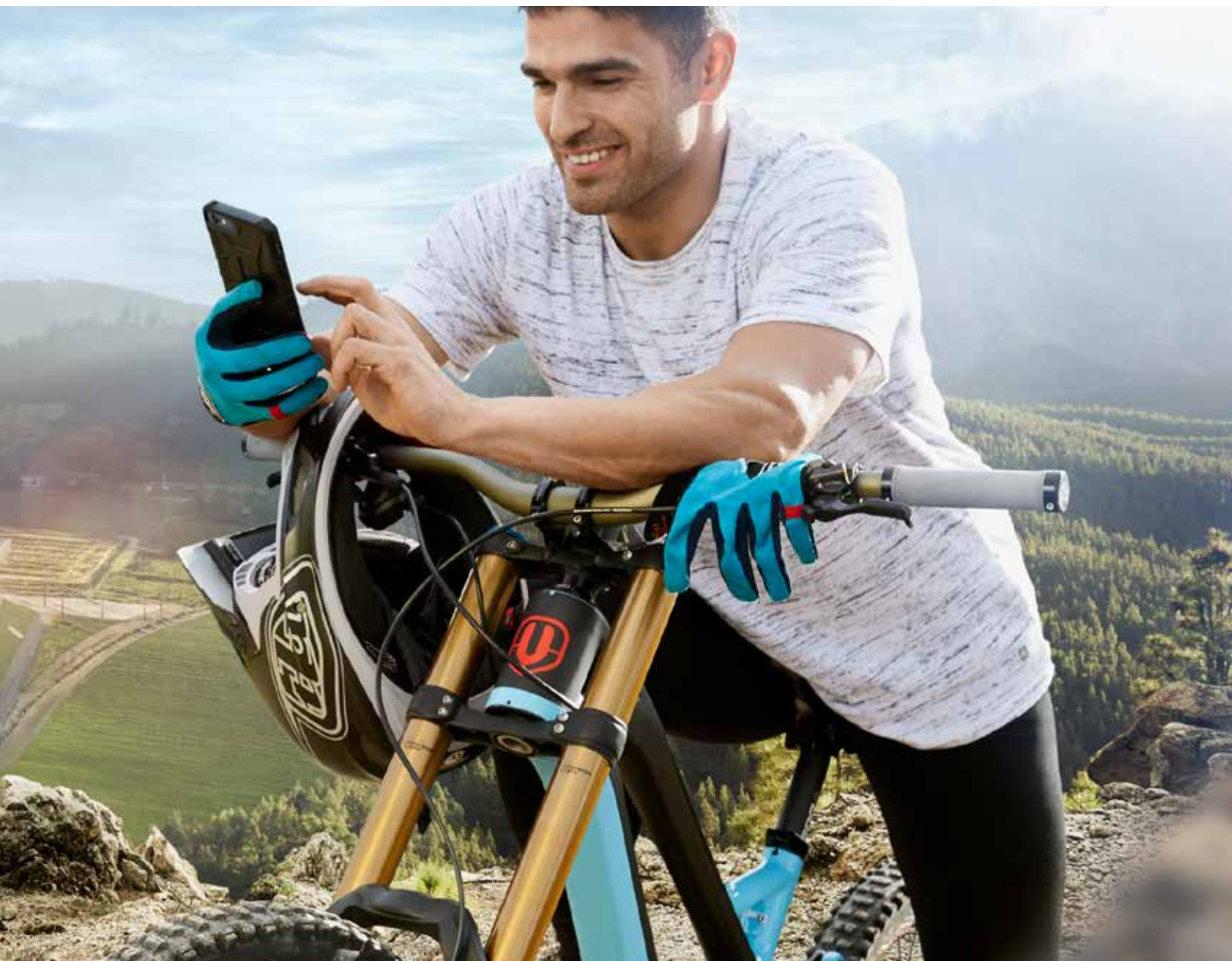

Distinctive features

Ease of use and installation



Maximum flexibility for every application – SACE Tmax XT sets standards for electrical installations. Easy selection, one-fits-all accessories and intuitive design pave the way for fast upgrades and create values through the entire customer journey. Even for the most critical projects.



Ease of selection

The clever organization of the SACE Tmax XT range and the user-friendly software e-Configure allows the customer to easily select and customize the right products for their needs.

One-fits-all accessories

Improving the circuit-breaker from its basic functions to a more versatile and sophisticated device is

made possible thanks to the SACE Tmax XT modular structure and the variety of available accessories.

Upgradability

The Ekip Touch and Hi-Touch trip units can always be upgraded via ABB Ability Marketplace™ and new functionalities shall be always available for an ever ending future.



Distinctive features

Performance and protection



Continuity of service and equipment protection – SACE Tmax XT sets standards when extreme breaking capacity is needed. Sharing the same logics, interfaces and features regardless of operating voltage environmental conditions. Embedding the most advanced protections into the smallest of frames.



Electrical performances

SACE Tmax XT is designed and tested to meet any installation requirement, even the most critical ones.

Metering

SACE Tmax XT provides all the tools needed to set up a competent and effective energy management strategy thanks to the trip units able to measure electrical parameters with 1% accuracy certification.

Protections and logics

SACE Tmax XT integrates extra functionalities into the size of a standard molded case circuit-breaker. The most advanced protection functions and logics are available thanks to its cutting-edge trip units.



Distinctive features

Safety and reliability



Absolute attention to detail, with style from design to manufacturing SACE Tmax XT sets standards for edge technologies. Half a century of research and experience means top-level products that are ready to face future challenges.



Discover more about SACE Tmax XT



Web page: go.abb/XT



Products conformity

SACE Tmax XT circuit-breakers and their accessories comply with UL489 and CSA C22.2 Standards

Compliance with Standards

The Tmax XT circuit-breakers and their accessories are constructed in compliance with:

- Standards:
 - UL489 and CSA C22.2;
- Directives:
 - EC “Low Voltage Directive” (LVD) N° 2014/35/EC;
 - EC “Electromagnetic Compatibility Directive” (EMC) 2014/30/EC;



CCC



JIS



KC



Registro Italiano Navale (RINA):
Italy



Lloyd's Register of Shipping (LR):
United Kingdom



American Bureau Shipping (ABS):
United States of America

Shipping Registers:

- Lloyd's Register of Shipping, Germanischer Lloyd, Bureau Veritas, Rina, Det Norske Veritas, Russian Maritime Register of Shipping, ABS.

Certification of conformity with product Standards is carried out at the ABB SACE test laboratory (accredited by SINAL) in compliance with the EN 45011 European Standard, by the Italian certification body ACAE, member of the European LOVAG organization and by the Swedish certification body SEMKO recognized by the international IECCE organization.



Germanischer Lloyd (GL):
Germany



Bureau Veritas (BV):
France



Det Norske Veritas (DNV):
Norway



Russian Maritime Register of Shipping (RMRS):
Russia



Nippon Kaiji Kyokai (NKK):
Japan



Gost - Eac

For more information about circuit-breakers, certified ratings and their corresponding validity, please contact ABB SACE.



Company Quality System

The ABB SACE Quality System complies with the following Standards:

- ISO 9001 International Standard;
- EN ISO 9001 (equivalent) European Standard;
- UNI EN ISO 9001 (equivalent) Italian Standard;
- IRIS International Railway Industry Standards.

The ABB SACE Quality System attained its first certification by the RINA certification body in 1990.

Environmental Health & Safety Management System, Social Responsibility and Ethics

Special care for the environment is a priority commitment for ABB SACE. This is confirmed through the company's Environmental Management System which is certified by the RINA (ABB SACE was the first industry in the electromechanical sector in Italy to obtain this recognition) in conformity with the International ISO14001 Standard. In 1999 the Environmental Management System was integrated with the Occupational Health and Safety Management System according to the OHSAS 18001 Standard and later, in 2005, with the SA 8000 (Social Accountability 8000) Standard. All this amounts to solid evidence of ABB's commitment to respecting business ethics and promoting a safe and healthy working environment.

ISO 14001, OHSAS 18001 and SA8000 recognitions together with ISO 9001 made it possible to obtain RINA BEST 4 (Business Excellence Sustainable Task) certification.

In addition to this, the following markings and certifications have been achieved :

- GISA 01.02A03;
- LCA (Life Cycle Assessment).

Product Material Compliance

The XT family complies with the following international regulations:

- RoHS II, Directive 2011/65/EC;
- China RoHS;
- REACH, 2006/1907/EC, Registration, Evaluation, Authorisation and Restriction of Chemicals;
- WEEE 2012/19/EU -Waste Electrical & Electronic Equipment;
- Conflict Minerals - Dodd-Frank Consumer Protection Act. Section 1502.



Construction characteristics

All the SACE Tmax XT molded case circuit-breakers are built in accordance with the following constructional characteristics.

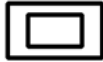

Double insulation

The Tmax XT circuit-breaker has double insulation between the live power parts (excluding the terminals) and the front parts of the apparatus where the operator works during normal operation. The mounting location of each electrical accessory is completely segregated from the power circuit, preventing any risk of contact with live parts. The operating mechanism especially is completely insulated from the energized circuits.

Furthermore, the circuit-breaker has oversized insulation, both between the live internal parts and near the connection terminals. Furthermore, the clearances exceed those required by the IEC Standards and fully comply with the prescriptions of the UL 489 Standard.

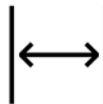

Insulation behaviour

In the open position, the circuit-breaker guarantees insulation distances in compliance with the UL489 Standard, thus preventing leakage currents to flow between the input and output terminals.



Positive operation

The operating lever always indicates the precise position of the moving contacts of the circuit-breaker, thereby guaranteeing safe and reliable signals, in compliance with IEC 60073 and IEC 60417 Standards (I = Closed; O = Open; yellow-green line = open due to protection trip). The circuit-breaker operating mechanism has a free release regardless of the pressure on the lever and the speed of operation. Protection tripping automatically opens the moving contacts: to re-close them, the operating mechanism must first be reset by pushing the operating lever from the intermediate position to the lowest open position.



Tropicalization

Circuit-breakers and accessories in the Tmax XT series are tested in compliance with the IEC 60068-2-30 Standard, carrying out 2 cycles at 55 °C with the “variant 1” method (clause 7.3.3). The suitability of the Tmax XT series under the most severe environmental conditions is further ensured with hot-humid climate according to climatograph 8 in the IEC 60721-2-1 Standards thanks to:

- molded insulating cases made of synthetic resins reinforced with glass fibers;
- anti-corrosion treatment of the main metallic parts;
- Fe/Zn 12 zinc-plating (ISO 2081) protected by a conversion layer, free from hexavalent chromium (ROHS-compliant), with the same corrosion resistance guaranteed by ISO 4520 class 2C;
- application of anti-condensation protection for electronic overcurrent trip units and relative accessories.

The ranges

- 2/2** **SACE Tmax XT automatic circuit-breakers for alternating current (AC) distribution**
- 2/6** **SACE Tmax XT automatic circuit-breakers for direct current (DC) distribution**
- 2/10** **SACE Tmax XT molded case switches (MCS)**
- 2/14** **Current Limiting**
- 2/15** **100% rated circuit-breakers**
- 2/16** **Circuit-breakers for motor protection**
Main characteristics

SACE Tmax XT automatic circuit-breakers for alternating current (AC) distribution



Molded case circuit-breakers (MCCB)			XT1		
Frame Size	[A]		125		
Poles	[No.]		3, 4		
Rated voltage	(AC) 50-60Hz	[V]	600Y/347		
Versions			Fixed, Plug-in		
Interrupting ratings			N	S	H
	240 V (AC)	[kA]	50	65	100
	480 V (AC)	[kA]	25	35	65
	600Y/347 V (AC)	[kA]	18	22	25
Mechanical life		[No. Operations]	25000		
		[No. Hourly operations]	240		
Dimensions - Fixed (Width x Depth x Height)	3 poles	[mm]/[in]	[76.2 x 70 x 130] / [3 x 2.75 x 5.12]		
	4 poles	[mm]/[in]	[101.6 x 70 x 130] / [4 x 2.75 x 5.12]		
Weight	Fixed 3/4 poles	[kg]/[lbs]	[1.1 - 2.43] / [1.4 - 3.07]		
	Plug-in (EF) 3/4 poles	[kg]/[lbs]	[2.21 - 4.87] / [2.82 - 6.22]		
	Withdrawable (EF) 3/4 poles	[kg]/[lbs]	-		
Trip units for power distribution					
TMF			■		
TMA					
Ekip Dip					
Ekip Touch					
Interchangeable protection trip units					

(1) Current Limiting circuit-breaker in 480V AC and 600V AC

(2) 2-poles version available only as complete circuit-breaker with TMF, trip units interchangeable;

4-poles version available only as complete circuit-breaker from In=80 to In=250 with TMF, trip units interchangeable



XT2						XT3				XT4				
125						225				250				
3, 4						3, 4				2 (for N fixed version only) 3, 4 ⁽²⁾				
600						600Y/347				600				
Fixed, Plug-in, Withdrawable						Fixed, Plug-in				Fixed, Plug-in, Withdrawable				
N	S	H ⁽¹⁾	L ⁽¹⁾	V ⁽¹⁾	X	N	S	N	S	H ⁽¹⁾	L ⁽¹⁾	V ⁽¹⁾	X	
65	100	150	200	200	200	50	65	65	100	150	200	200	200	
25	35	65	100	150	200	25	35	25	35	65	100	150	200	
-	-	-	-	-	-	10	10	-	-	-	-	-	-	
18	22	25	35	42	42	-	-	18	22	25	50	65	100	
25000						25000				25000				
240						240				240				
[90 x 82.5 x 130] / [3.54 x 3.25 x 5.12]						[105 x 70 x 150] / [4.13 x 2.75 x 5.90]				[105 x 82.5 x 160] - [4.13 x 3.25 x 6.3]				
[120 x 82.5 x 130] / [4.72 x 3.25 x 5.12]						[140 x 70 x 150] / [5.51 x 2.75 x 5.90]				[140 x 82.5 x 160] - [5.51 x 3.25 x 6.3]				
[1.2 - 2.65] / [1.6 - 3.53]						[1.7 - 3.37] / [2.1 - 4.63]				[2.5 - 5.51] / [3.5 - 7.72]				
[2.54 - 5.60] / [3.27 - 7.21]						[3.24 - 7.14] / [4.1 - 9.04]				[4.19 - 9.24] / [5.52 - 12.17]				
[3.32 - 7.32] / [4.04 - 8.91]										[5 - 11.02] / [6.76 - 14.90]				
■						■				■				
■										■				
■										■				
■										■				
■										■				

SACE Tmax XT automatic circuit-breakers for alternating current (AC) distribution



Molded case circuit-breakers (MCCB)			XT5				
Frame Size	[A]	400-600					
Poles	[No.]	3, 4					
Rated voltage	(AC) 50-60Hz [V]	600					
Versions		Fixed ,Plug-in, Withdrawable					
Interrupting ratings		N	S	H ⁽¹⁾	L ⁽¹⁾	V ⁽¹⁾	X
	240 V (AC) [kA]	65	100	150	200	200	200
	480 V (AC) [kA]	35	50	65	100	150	200
	600Y/347 V (AC) [kA]	-	-	-	-	-	-
	600 V (AC) [kA]	18	25	35	65	100	100
Mechanical life	[No. Operations]	20.000					
	[No. Hourly operations]	240					
Dimensions - Fixed	3 poles [mm]/[in]	[140 x 103 x 205] - [5.51 x 4.05 x 8.07]					
(Width x Depth x Height)	4 poles [mm]/[in]	[186 x 103 x 205] - [7.32 x 4.05 x 8.07]					
Weight	Fixed 3/4 poles [kg]/[lbs]						
	Plug-in (EF) 3/4 poles [kg]/[lbs]						
	Withdrawable (EF) 3/4 poles [kg]/[lbs]						
Trip units for power distribution							
TMF							
TMA							
Ekip Dip							
Ekip Touch							
Interchangeable protection trip units							

(1) Current Limiting circuit-breaker in 480V AC and 600V AC



XT6			XT7			XT7 M		
800			800-1000-1200			800-1000-1200		
3, 4			3, 4			3, 4		
600			600			600		
Fixed , Withdrawable			Fixed , Withdrawable			Fixed , Withdrawable		
N	S	H	S	H	L	S	H	L
65	100	200	65	100	200	65	100	200
35	50	65	50	65	100	50	65	100
20	25	35	25	50	65	25	50	65
	20.000			10.000			10.000	
	240			240			240	
	[210 x 103.5 x 268] - [8.27 x 4.07 x 10.55]			[210 x 167 x 268] - [8.27 x 6.57 x 10.55]			[210 x 178 x 268] - [8.27 x 7.01 x 10.55]	
	[280 x 103.5 x 268] - [11.02 x 4.07 x 10.55]			[280 x 166 x 268] - [11.02 x 6.57 x 10.55]			[280 x 178 x 268] - [11.02 x 7.01 x 10.55]	

■								
■			■			■		
			■			■		
■			■			■		

SACE Tmax XT automatic circuit-breakers for direct current (DC) distribution



Molded case circuit-breakers (MCCB)			XT1		
Frame Size	[A]		125		
Poles	[No.]		3, 4		
Rated voltage (DC)	[V]		500		
Versions			Fixed, Plug-in		
Interrupting ratings			N	S	H
	250 V (DC) 2 poles in series	[kA]	35	42	50
	500 V (DC) 2 poles in series		-	-	-
	500 V (DC) 3 poles in series	[kA]	-	-	-
	500 V (DC) 4 poles in series	[kA]	35	50	50
	600 V (DC) 3 poles in series	[kA]	-	-	-
Mechanical life		[No. Operations]	25000		
		[No. Hourly operations]	240		
Dimensions	Fixed 3 poles	[mm]/[in]	[76.2 x 70 x 130] / [3 x 2.75 x 5.12]		
(Width x Depth x Height)	4 poles	[mm]/[in]	[101.6 x 70 x 130] / [4 x 2.75 x 5.12]		
Weight	Fixed 3/4 poles	[kg]/[lbs]	[1.1 - 2.43] / [1.4 - 3.07]		
	Plug-in (EF) 3/4 poles	[kg]/[lbs]	[2.21 - 4.87] / [2.82 - 6.22]		
	Withdrawable (EF) 3/4 poles	[kg]/[lbs]	-		
Trip units for power distribution					
	TMF		■		
	TMA				
	TMG		-		



XT2						XT3	
125						225	
3, 4						3, 4	
500						500	
Fixed, Plug-in, Withdrawable						Fixed, Plug-in	
N	S	H	L	V	X	N	S
35	50	65	75	85	85	25	35
-	-	-	-	-	-	-	-
35	50	65	75	85	85	25	35
-	-	-	-	-	-	-	-
-	-	-	-	-	-	-	-
25000						25000	
240						240	
[90 x 82.5 x 130] / [3.54 x 3.25 x 5.12]						[105 x 70 x 150] / [4.13 x 2.75 x 5.90]	
[120 x 82.5 x 130] / [4.72 x 3.25 x 5.12]						[140 x 70 x 150] / [5.51 x 2.75 x 5.90]	
[1.2 - 2.65] / [1.6 - 3.53]						[1.7 - 3.37] / [2.1 - 4.63]	
[2.54 - 5.60] / [3.27 - 7.21]						[3.24 - 7.14] / [4.1 - 9.04]	
[3.32 - 7.32] / [4.04 - 8.91]							
■						■	
■							
-						-	

SACE Tmax XT automatic circuit-breakers for direct current (DC) distribution



Molded case circuit-breakers (MCCB)			XT4					
Frame Size	[A]		250					
Poles	[No.]		3, 4					
Rated voltage (DC)	[V]		600					
Versions			Fixed, Plug-in, Withdrawable					
Interrupting ratings			N	S	H	L	V	X
	250 V (DC) 2 poles in series	[kA]	35	42	50	85	100	100
	500 V (DC) 2 poles in series							
	500 V (DC) 3 poles in series	[kA]	-	-	-	-	-	-
	500 V (DC) 4 poles in series	[kA]	-	-	-	-	-	-
	600 V (DC) 3 poles in series	[kA]	35	50	65	75	85	85
Mechanical life		[No. Operations]	25000					
		[No. Hourly operations]	240					
Dimensions	Fixed 3 poles	[mm]/[in]	[105 x 82.5 x 160] - [4.13 x 3.25 x 6.3]					
(Width x Depth x Height)	4 poles	[mm]/[in]	[140 x 82.5 x 160] - [5.51 x 3.25 x 6.3]					
Weight	Fixed 3/4 poles	[kg]/[lbs]	[2.5 - 5.51] / [3.5 - 7.72]					
	Plug-in (EF) 3/4 poles	[kg]/[lbs]	[4.19 - 9.24] / [5.52 - 12.17]					
	Withdrawable (EF) 3/4 poles	[kg]/[lbs]	[5 - 11.02] / [6.76 - 14.90]					
Trip units for power distribution								
TMF			■					
TMA			■					
TMG			-					



XT5						XT6		
400-600						800		
3, 4						3, 4		
600						600		
Fixed, Plug-in, Withdrawable						Fixed, Withdrawable		
N	S	H	L	V	X	N	S	H
35	50	70	100	100	100	35	50	70
25	35	50	70	100	100	35	35	50
-	-	-	-	-	-	-	-	-
-	-	-	-	-	-	-	-	-
16	25	35	50	70	70	20	20	35
20.000						20.000		
240						240		
[140 x 103 x 205] - [5.51 x 4.05 x 8.07]						[210 x 103.5 x 268] - [8.27 x 4.07 x 10.55]		
[186 x 103 x 205] - [7.32 x 4.05 x 8.07]						[280 x 103.5 x 268] - [11.02 x 4.07 x 10.55]		
■						■		
■						-		

SACE Tmax XT molded case switches (MCS)

Molded case switches are devices created from the corresponding circuit-breakers and feature the same overall dimensions, versions, and can be fitted with the same accessories.

Applications

These devices are mainly used as:

- general disconnection devices in sub-switchboards;
- switching and insulation devices for lines, bus bars or groups of apparatus;
- bus ties.

In the open position, the switch guarantees

a sufficient insulation distance (between the contacts) to ensure safety and to prevent an electrical arc from striking.

Characteristics of molded case switches according to UL489 and CSA C22.2 No.5

		XT1D			XT2D				XT3D		
Frame Size	[A]	125			125				225		
Poles	[No.]	3, 4			3, 4				3, 4		
Rated service voltage	(AC) 50-60Hz [V]	600Y/347			600				600Y/347		
	(DC) [V]	500 4p series / 3p CB up to 250V DC 3p series			500 3p series				500 3p series		
Versions		Fixed, Plug-in			Fixed, Plug-in, Withdrawable				Fixed, Plug-in		
Interrupting Rating		N	S	H	N	S	H	L	V	N	S

Characteristics of molded case switches according to IEC60947-3

Size		XT1D			XT3D			XT4D	
Rated operating current. Ie	(AC) 50-60Hz	125							
AC-22A	415-440Vac	125			225			150/250	
AC-23A		125			200			150/200	
AC-22A	690V AC	125			225			150/250	
AC-23A					200			150/200	
Rated operating current. Ie	DC								
DC-22A	250V DC	125 - 2p in series			225 - 2p in series			150/250 - 2p in series	
DC-23A		125 - 2p in series			200 - 2p in series			150/200 - 2p in series	
DC-22A	500V DC	125 - 4P in series			225 - 3p in series			150/250 - 2p in series	
DC-23A		125 - 4P in series			200 - 3p in series			150/200 - 2p in series	
DC-22A	750V DC	-			-			-	
DC-23A		-			-			-	
Electrical life AC22 / AC23 (AC) 440 V In									
Mechanical life									

Protection

Each molded case switch must be protected on the supply side by a coordinated device which safeguards it against short-circuits.

The section "Coordination" in the table below shows the correspondence between each molded case switch and the relevant circuit-breaker.

Making capacity

The making capacity Icm is highly important since a molded case switch must be able to withstand the dynamic, thermal and current stresses which can occur during closing operations without being destroyed, right up to short-circuit closing conditions.

XT4D					XT5D					XT6D			XT7D/XT7D M		
150/250					400 - 600					800			1000 - 1200		
3, 4					3, 4					3, 4			3, 4		
600					600					600			600		
600 3p series					600 3p series					600 3p series			-		
Fixed, Plug-in, Withdrawable					Fixed, Plug-in, Withdrawable					Fixed, Withdrawable			Fixed, Withdrawable		
N	S	H	L	V	N	S	H	L	V	N	S	H	S	H	L

XT5D		XT6D		XT7D		XT7D M	
400	600	800	800	1000 - 1200	1000 - 1200	1000 - 1200	1000 - 1200
400	600	800	800	1000 - 1200	1000 - 1200	1000 - 1200	1000 - 1200
400	600	800	800	1000 - 1200	1000 - 1200	1000 - 1200	1000 - 1200
400	600	800	800	1000 - 1200	1000 - 1200	1000 - 1200	1000 - 1200
400 2p in series	600 2p in series	800 - 2p in series	800 - 2p in series	1000 - 1200 - 2p in series	1000 - 1200 - 2p in series	1000 - 1200 - 2p in series	1000 - 1200 - 2p in series
400 2p in series	600 2p in series	800 - 2p in series	800 - 2p in series	1000 - 1200 - 2p in series	1000 - 1200 - 2p in series	1000 - 1200 - 2p in series	1000 - 1200 - 2p in series
400 2p in series	600 2p in series	800 - 2p in series	800 - 2p in series	1000 - 1200 - 3p in series	1000 - 1200 - 3p in series	1000 - 1200 - 3p in series	1000 - 1200 - 3p in series
400 2p in series	600 2p in series	800 - 2p in series	800 - 2p in series	1000 - 1200 - 3p in series	1000 - 1200 - 3p in series	1000 - 1200 - 3p in series	1000 - 1200 - 3p in series
400 3p in series	600 3p in series	800 - 3p in series	800 - 3p in series	1000 - 1200 - 4p in series	1000 - 1200 - 4p in series	1000 - 1200 - 4p in series	1000 - 1200 - 4p in series
400 3p in series	600 3p in series	800 - 3p in series	800 - 3p in series	1000 - 1200 - 4p in series	1000 - 1200 - 4p in series	1000 - 1200 - 4p in series	1000 - 1200 - 4p in series
5.000	3.000	3.500	3.500	2.500	2.500	2.500	2.500
20.000	20.000	20.000	20.000	20.000	20.000	20.000	20.000

SACE Tmax XT molded case switches (MCS)

Coordination

Supply side	XT1			XT3			XT2			
Version	N	S	H	N	S	N	S	H	L	V
SCCR 480 VAC [kA]	25	35	65	25	35	25	35	65	100	150
	In									
XT1N-D	25	25	25			25	25	25	25	25
XT1S-D		35	35				35	35	35	35
XT1H-D			65					65	65	65
XT2N-D	25	25	25			25	25	25	25	25
XT2H-D			65					65	65	65
XT2L-D									100	100
XT2V-D							25			150
XT3N-D	25	25	25	25	25	25	25	25	25	25
XT3S-D		35	35		35		35	35	35	35
XT4N-D	25	25	25	25 ⁽¹⁾	25 ⁽¹⁾	25	35	25	25	25
XT4S-D		35	35		35 ⁽¹⁾		35	35	35	35
XT4H-D			65					65	65	65
XT4L-D									100	100
XT4V-D										150
XT5N-D										
XT5S-D										
XT5H-D										
XT5L-D										
XT5V-D										
XT6N-D										
XT6S-D										
XT6H-D										
XT7S-D										
XT7H-D										
XT7L-D										

(1) the configuration is valid only with I1<225A setting on Tmax XT4 circuit-breaker

(2) the configuration for Tmax XT4D 150 is valid only with I1<150A setting on Tmax XT4 circuit breaker

Current Limiting

Existing UL circuit-breakers Tmax XT2, XT4 and XT5 have undergone specific tests as per the UL 489 Standard in order to be classified as UL current limiting circuit-breakers. They have specific characteristics in terms of limiting peak current and specific let-through energy.

According to the UL 489 Standard, current limiting circuit-breakers will be marked "Current Limiting" on the front and will have a label on the right side specifying the peak current and specific let-through energy values. Accessories and trip are the same as available for standard UL Tmax MCCBs.

Circuit-breaker	XT2			XT4			XT5		
Trip Units	TMF, TMA, Ekip			TMF, TMA, Ekip			TMF, TMA, Ekip		
In	Up to 125A ⁽¹⁾			Up to 250A ⁽²⁾			Up to 600A		
Voltage	Up to 600V			Up to 600V			Up to 600V		
Breaking Capacity	H	L	V	H	L	V	H	L	V

(1) Includes TMF, TMA with In = 15-125A and Ekip with In= 10, 25, 60, 100, 125A

(2) Includes TMF, TMA with In = 25-250A and Ekip with In= 40, 60, 100, 150, 225, 250A

100% rated circuit-breakers

All Tmax XT circuit-breakers are available both as standard version and as 100% rated version. Because of the additional heat generated bringing

100% of continuous current rating, the use of specific 90°C rated wires sized per 75°C ampacity may be required.

Fixed circuit-breakers

XT1	Suitable for continuous operation at 100-percent of rating up to 100A with 90°C wire. The wire size shall be based on the ampacity of 75°C rated wire.
XT2	Suitable for continuous operation at 100-percent of rating up to 100A with thermal magnetic trip unit and up to 125A with electronic trip unit.
XT3	Suitable for continuous operation at 100-percent of rating up to 225A with 90°C wire. The wire size shall be based on the ampacity of 75°C rated wire.
XT4	Suitable for continuous operation at 100-percent of rating up to 250A, with 90°C wire. The wire size shall be based on the ampacity of 75°C rated wire. With 75°C wire suitable for continuous operation at 100-percent of rating up to 200A with lugs FC CuAl only.
XT5 400	Suitable for continuous operation at 100-percent of rating up to 400A. For XT5 V-X 90°C wire needed, the wire size shall be based on the ampacity of 75°C rated wire.
XT5 600	N-S-H-L versions suitable for continuous operation at 100-percent of rating up to 600A with 90°C wire. The wire size shall be based on the ampacity of 75°C rated wire.
XT6	Suitable for continuous operation at 100-percent of rating up to 800A with 90°C wire. The wire size shall be based on the ampacity of 75°C rated wire.
XT7	Suitable for continuous operation at 100-percent of rating up to 1200A with 90°C wire. The wire size shall be based on the ampacity of 75°C rated wire.

For 80% - 100% rated enclosure dimensions and further installation details, please refer to the document "Technical characteristics SACE Tmax XT UL/CSA" (1SDC 210199D0202)

Circuit-breakers for motor protection

Main characteristics

When choosing and manufacturing a system for starting and monitoring motors, safety and reliability are important considerations. Motor starting is a particularly critical phase for the motor itself and for the installation powering it.

Even rated service needs to be adequately monitored and protected in order to deal with any faults that might occur.

When it comes to direct starting, ABB SACE offers two different solutions:

- a conventional system equipped with a circuit-breaker with a magnetic only trip unit for protection against shortcircuits, a thermal trip unit for protection against overloads and phase failure or unbalance, and a contactor to operate the motor;
- an advanced protection system which integrates all the protection and monitoring functions in the circuit-breaker itself and a contactor for operating the motor.

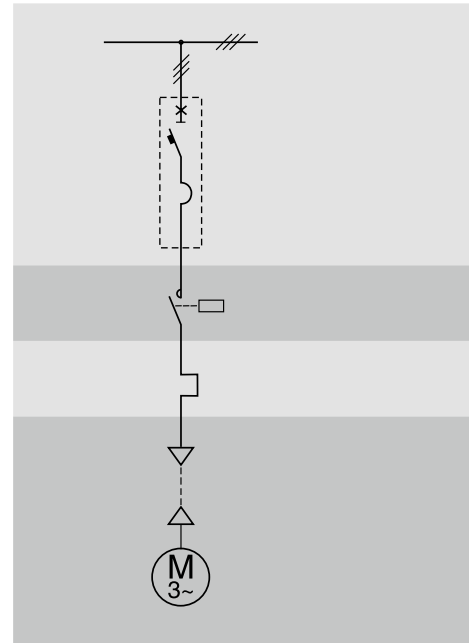

Conventional system

Several different factors must be considered when choosing and coordinating the protection and operating devices, e.g.:

- the electrical specifications of the motor (type, power rating, efficiency, $\cos\Phi$);
- the starting type and diagram;
- the fault current and voltage in the part of the network where the motor is installed.

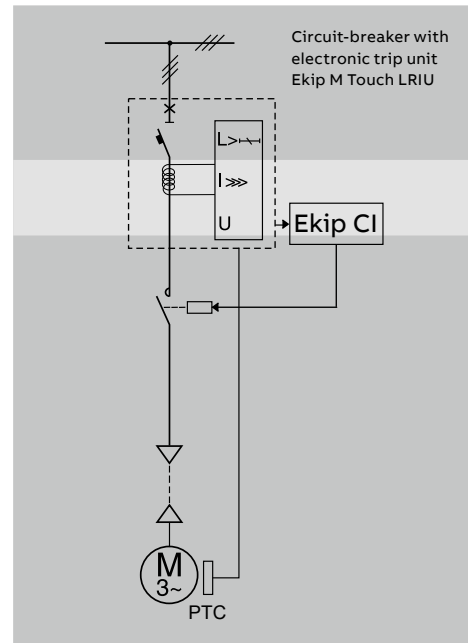

Advanced protection system

Circuit-breakers for motor protection

Main characteristics

Motor protection		XT1	XT2			XT3
Frame Size	[A]	125	125			225
Poles	[No.]	3	3			3
Rated service voltage	(AC) 50-60Hz [V]	600Y/347	600			600Y/347
	(DC) [V]	500	500			500
Versions		Fixed, Plug-in	Fixed, Plug-in, Withdrawable			Fixed, Plug-in
Rating level		H	H	L	V	S
Trip units for motor protection						
MA (MCP)		■	■	■		■
Ekip M Dip I (MCP)			■	■	■	
Ekip M Dip LIU (MPCB)			■	■	■	
Ekip M Touch LRIU (MPCB)			■	■	■	

XT4					XT5					XT6			XT7		
250					400 - 600					800			800 - 1000- 1200		
3					3					3			3		
600					600					600			600		
600					600					600			600		
Fixed, Plug-in, Withdrawable					Fixed, Plug-in, Withdrawable					Fixed, Withdrawable			Fixed, Withdrawable		
H	L	V	X	N	S	H	L	V	X	N	S	H	S	H	L
■	■			■	■	■	■	■	■						
■	■	■	■	■	■	■	■	■	■	■	■	■	■	■	■
■	■	■	■	■	■	■	■	■	■	■	■	■			
■	■	■	■	■	■	■	■	■	■				■	■	■

Protection trip units

3/2	Introduction
3/4	New digital experience
3/14	Offer
	Thermal-magnetic trip unit
3/18	Overview
3/20	Settings
	Ekip Dip
3/22	Overview
3/24	Protection settings
	Ekip Touch/Hi-Touch
3/26	Overview
3/32	Protection functions
3/46	Additional functions
3/48	Protection settings
3/54	Tolerances
3/56	Measurement functions and data

Introduction

SACE Tmax XT trip units break new ground: they represent a new benchmark for the molded case circuit-breakers as they are able to satisfy any performance requirement.

The Tmax XT trip units are designed to be used in a wide range of applications. This complete, flexible protection trip unit can be adapted to the actual level of protection required, independently of the complexity of the system.

The range is available for three levels of performances, to meet any requirement, from simple to advanced applications.

- **TM, thermal-magnetic trip unit**
- **Ekip Dip, electronic trip unit**
- **Ekip Touch/Hi-Touch, electronic trip units**





Thermal-magnetic trip units

Used in both AC and DC networks, these are a solution for protection against overloads and short-circuits. Overload protection is ensured thanks to ABB thermal device based on a temperature dependent bimetal heated by the current. Protection against short-circuiting is realized with a magnetic device.

The Ekip Dip trip units

The first level of electronic trip units, used for the protection of AC network: these are based on microprocessor technologies and guarantee high reliability and tripping precision. They provide protection against overloads, selective short-circuits, short-circuits and earth faults. The power required for their operation is provided directly from the current sensors.

The Ekip Touch/Hi-Touch trip units

These represent the state of the art in terms of technology for AC network protection with advanced protection and system management functions. Diverse communication protocols enable the reading of measurement parameters and circuit-breaker control remotely.

Class 1 active energy measurement in compliance with the IEC 61557-12 Standard permits highly demanding requirements of energy efficiency to be satisfied. The integrated display makes interaction with the Ekip Touch/Hi-Touch an easy and intuitive experience for the user and the embedded Bluetooth functionality allows fast interaction via EPiC (Electrification Products intuitive Configurator), the new application to configure and check the status of the ABB low voltage circuit breakers.

The Ekip Touch trip unit guarantees maximum flexibility. In fact, by selecting among the numerous software solutions available, it is possible to customize the functionality of the device at will. On the other side, the Ekip Hi-Touch trip unit includes all functions by default, representing the top-of-the-line in the SACE Tmax XT offer.

New digital experience

With the new Ekip Touch and Hi-Touch trip units, it is always possible to select and install the desired functions on the device. The functions can be selected when ordering the circuit-breaker or downloaded directly from the ABB Ability Marketplace™, even from a smart phone or tablet, thus reducing installation time to zero.

New digital experience

Ekip Touch/Hi-Touch trip units can be now customized with the functions required.

—

Ekip Touch/Hi-Touch always allow the user to enter in a new product experience thanks to the possibility to build up his own tailor-made trip unit by selecting the set of protections, measurements and logics.

Circuit-breakers' customization has never been so easy.

With the new Ekip Touch and Hi-Touch trip units, the most advanced functionalities can be enabled following two different purchasing processes:

- **1 ABB Ability Marketplace™**

Users can download digital upgrades via web and enable them directly on the trip unit, without removing the circuit-breaker from the installation point, with zero shipping time and no installation costs. This process allows additional functions to be selected after the trip unit has been already received on site and installed. Moreover, stock can be optimized by keeping in the warehouse few types of trip units and customizing them according to the customer's specific needs. Once purchased, each function can be easily activated by using a smartphone or tablet via EPiC and embedded Bluetooth connectivity, or a laptop with Ekip Connect 3 and an Ekip T&P.

- **2 Traditional ordering**

This option represents the standard way to order ABB devices. The traditional process allows the users to select and directly install the desired functions when ordering the circuit-breaker. Once received and installed, SACE Tmax XT always offers the possibility to add new functionalities via ABB Ability Marketplace™.

The new Ekip digital offering includes:

- **Packages**

The software packages offer the possibility to customize the circuit-breaker by selecting additional protection functions and measurements. The device can be personalized to create tailor-made solutions according to the specific application. Maximum flexibility is guaranteed by offering specific technical features that can be combined in the Ekip Touch/Hi-Touch during the product life cycle.

- **Bundles**

Simplify the selection of advanced functions and logics with group of packages able to satisfy requirements by market segments and applications.

Bundles shall require additional plug and play hardware modules.

- **Solutions**

The SACE Tmax XT circuit-breaker is no more intended as a simply stand-alone protection device, but it has become an active player in the electrical system, able to exchange data and trigger actions managing the behavior of other connected devices. Thanks to the new electronic trip units, it is possible to implement transfer logics, load shedding and peak shaving strategies. Such solutions require additional plug and play hardware modules and other smart devices.

SACE Tmax XT allows to easily upgrade and customize the Ekip Touch and Hi-Touch trip units, guaranteeing maximum flexibility for any application, and delivering value throughout the entire customer journey.

1. Design



Build the circuit-breaker according to specific project requirements.

2. Commissioning



Customize the device thanks to the digital offering. Manage last minute changes through digital upgrades.

3. Service



Unlock the full potential of the circuit-breaker at any time, minimizing downtime and installation changes.

Key drivers

- Ease of doing business
- Technical specifications
- Application and function

Benefits

- Flexibility of choice
- Customization by application

Key drivers

- Ease of doing business
- Management of components
- Time to market

Benefits

- Stock optimization
- Zero lead time and installation effort

Key drivers

- Manage installed base
- Simplify diagnostics
- Simplify the hardware re-design

Benefits

- Zero lead time and installation effort
- Avoid downtime

New digital experience

Packages

Each package includes a set of protection functions or measurements that can be enabled in the trip unit.

Six packages relate to protection functions: Voltage Protections, Frequency Protections, Power Protections, Advanced Voltage Protections, ROCOF Protections and Adaptive Protections.



Voltage Protections

Set of protections included: UV - Undervoltage, OV - Overvoltage, UV2 - 2nd Undervoltage, OV2 - 2nd Overvoltage, PS - Phase Sequence, VU - Voltage unbalance.

How to order: via ABB Ability Marketplace™ or traditional ordering channels.



Frequency Protections

Set of protections included: UF - Underfrequency, OF - Overfrequency, UF2 - 2nd Underfrequency, OF2 - 2nd Overfrequency.

How to order: via ABB Ability Marketplace™ or traditional ordering channels.



Power Protections

Set of protections included: RP - Reverse active power, Cos Φ - Power factor, D - Directional overcurrent, RQ - Loss of field or reverse reactive power, OQ - Reactive overpower, OP - Active over power, UP - Active underpower, RQ - 2nd Loss of field or Reverse reactive power.

How to order: via ABB Ability Marketplace™ or traditional ordering channels.



Advanced Voltage Protections

Set of protections included: S(V) - Voltage controlled overcurrent, S(V)2 - 2nd Voltage controlled overcurrent, R - Residual voltage.

How to order: via ABB Ability Marketplace™ or traditional ordering channels.

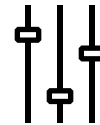

ROCOF Protections

Set of protections included: ROCOF - Rate of change of frequency.

How to order: via ABB Ability Marketplace™ or traditional ordering channels.



Adaptive Protections

Set of protections included: Dual Setting - Set A-B.

How to order: via ABB Ability Marketplace™ or traditional ordering channels.

Three packages relate to measurements and diagnostics: Measuring Package, Data Logger and Network Analyzer.



Measuring Package

To monitor the plant through several measurements: Phase-to-phase voltage, Phase-to-neutral voltage, Phase sequence, Frequency, Active power, Reactive power, Apparent power, Power factor, Peak factor.

How to order: via ABB Ability Marketplace™ or traditional ordering channels.

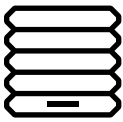

Data Logger

To record data about events in the plant: Currents, Voltages, Sampling rate, Maximum recording duration, Recording stop delay, Number of registers.

How to order: via ABB Ability Marketplace™ or traditional ordering channels.

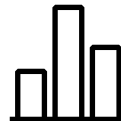

Network Analyzer

To monitor the power quality of the network through: Harmonic analysis, Hourly average voltage value, Short voltage interruption, Short voltage spikes, Slow-voltage sags and swells, Voltage unbalance.

How to order: via ABB Ability Marketplace™ or traditional ordering channels.













When a package is purchased via ABB Ability Marketplace™, it must be activated through:

- Ekip Connect 3 installed on a PC using Ekip T&P to scan the trip unit
- EPiC installed on a mobile device, by directly using the embedded Bluetooth connection available in the new Ekip trip units.

New digital experience Packages

Thanks to the maximum flexibility guaranteed by these packages, the new Ekip trip units are now completely customizable. Depending on the specific trip unit version, different packages are available by default, but all of them can be added to the trip unit.









Default functionalities and upgradability of the trip units:

												
	Standard Protection	Standard Measures	Measuring Package	Voltage Protections	Frequency Protections	Power Protections	Adaptive Protections	Adaptive Protections	Network Analyzer	Advanced Voltage Protections	ROCOF Protections	Power Controller
Ekip Touch	●	●	↑	↑	↑	↑	↑	↑	↑	↑	↑	↑
Ekip Touch Measuring	●	●	●	↑	↑	↑	↑	↑	↑	↑	↑	↑
Ekip G Touch	●	●	●	↑	↑	↑	↑	●	↑	↑	↑	↑
Ekip M Touch	●	●	●	●	●	↑	●	↑	↑	↑	↑	↑
Ekip Hi-Touch	●	●	●	●	●	↑	●	●	●	↑	↑	↑
Ekip G Hi-Touch	●	●	●	●	●	●	●	●	●	●	●	↑

● Available by default
 ↑ Updraggable
 ↑ Some functions available. Updraggable with the full package.

The flexibility offered by the packages allows also the selection of the proper functions that can be required by different segments and applications, purchasing only the needed functionalities.

Suggested packages by segment:

Packages									
	Wind	Solar	Data Center	Building Infrastructure	GenSet	Mining	Marine	Industries	Utilities
Voltage Protections	●	●		●	●		●		
Advanced Voltage Protections	●	●			●				
Frequency Protections	●	●			●	●		●	●
Power Protections			●	●		●		●	●
ROCOF Protections	●	●			●				
Adaptive Protections	●	●		●		●			
Measuring Package	●	●	●	●	●	●	●	●	●
Data Logger	●	●	●	●	●		●	●	
Network Analyzer	●	●	●	●	●	●	●		●
Power Controller			●	●		●			●

New digital experience

Bundles

Each bundle includes a set of packages that can be enabled on the trip unit.

Five bundles are available to satisfy different needs: Intelligent Grid Edge, Power Management, Grid Connection, Diagnostics and Measure Advanced.

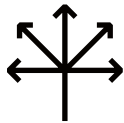

Intelligent Grid Edge

Make the grid smart.

Thanks to this bundle, the circuit-breaker becomes the main player of the smart interconnection of power distribution and loads for demand-supply coordination. Packages included: Measuring Package, Adaptive Protections, Power Protections, Voltage Protections and Ekip Power Controller.

How to order: via ABB Ability Marketplace™ or traditional ordering channels.

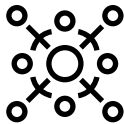

Power Management

Embedded demand management.

Thanks to this bundle, the circuit-breaker is ready for demand management to ensure service continuity and reduce energy costs. Packages included: Measuring Package, Adaptive Protections, Power Protections and Voltage Protections.

How to order: via ABB Ability Marketplace™ or traditional ordering channels.

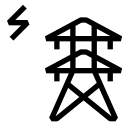

Grid Connection

Optimize renewable power generation.

No more external and additional relays are needed with this bundle. It enhances tracking and improved energy harvesting. Packages included: Measuring Package, Adaptive Protections, Power Protections and Ekip Power Controller.

How to order: via ABB Ability Marketplace™ or traditional ordering channels.



Diagnostics

Comprehensive data for root-cause analysis and preventive maintenance.

This bundle gives full diagnostics of the system to guarantee a full control of the plant status.

Packages included: Measuring Package, Network Analyzer and Data Logger.

How to order: via ABB Ability Marketplace™ or traditional ordering channels.

Available for Tmax XT5 and XT7 only.

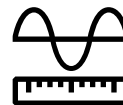

Measure Advanced

Embedded advanced metering and power quality information.

This bundle gives the possibility to preserve the loads, by avoiding equipment malfunctioning and optimizing energy consumption thanks to additional measurements and full power quality analysis. Packages included: Measuring Package, Network Analyzer.

How to order: via ABB Ability Marketplace™ or traditional ordering channels.

Available for Tmax XT5 and XT7 only.

When a bundle is purchased via ABB Ability Marketplace™, it must be activated through:









- Ekip Connect 3 installed on a PC using Ekip T&P to scan the trip unit
- EPiC installed on a mobile device, by directly using the embedded Bluetooth connection available in the new Ekip trip units.

New digital experience

Bundles

The flexibility offered by the bundles allows also the selection of the proper functions that can be required by different segments and applications, purchasing only the needed functionalities.

Suggested bundles by segment:

Bundle	 Wind	 Solar	 Data Center	 Building Infrastructure	 GenSet	 Mining	 Marine	 Industries	 Utilities
Intelligent Grid Edge			●	●	●				●
Power Management			●	●				●	●
Grid Connection	●	●						●	
Diagnostics	●	●	●	●	●	●	●		
Measure Advanced	●	●	●	●	●	●			

New digital experience

Solutions

Five solutions are available to fully exploit the potential of the Ekip architecture: Interface Protection System, Synchro Reclosing, Embedded ATS, Adaptive Load Shedding and Ekip Power Controller.



Interface Protection System

This solution is used to disconnect the generating units from the grid when voltage and frequency values are out of the ranges prescribed by the Standard. This disconnection is usually carried out through an Interface Device and an Interface Protection System. Thanks to the Ekip Touch/Hi-Touch trip units, this function is integrated in one single circuit-breaker. How to order: via ABB Ability Marketplace™ or traditional ordering channels. The hardware accessories must be ordered via traditional ordering channels.



Synchro Reclosing

Thanks to the Synchro Reclosing solution, the circuit-breaker is able to island the microgrid in case of disturbances due to faults or power quality events, and reconnect it to the distribution network when the proper conditions are guaranteed again. This last feature allows an islanded microgrid to be reconnected to the main grid, after the synchronism for automatic reclosure has been verified. How to order: via ABB Ability Marketplace™ or traditional ordering channels. The hardware accessories must be ordered via traditional ordering channels.

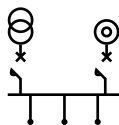

Embedded ATS

This function enables the activation of auxiliary generation sources (e.g. generators) and transfers the feed of the loads from the distribution network to such auxiliary sources, thus ensuring a secure

transfer to maintain service continuity and reliability of the system.

How to order: via ABB Ability Marketplace™ or traditional ordering channels. The hardware accessories must be ordered via traditional ordering channels.

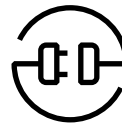

Adaptive Load Shedding

Thanks to this solution, the circuit-breaker enables islanding transition to avoid blackouts. It actively controls the power consumption based on the priorities set by the user. How to order: via ABB Ability Marketplace™ or traditional ordering channels. The hardware accessories must be ordered via traditional ordering channels.



Ekip Power Controller

This function is the ideal solution for load management and represents an optimum compromise between reliability, simplicity and cost-effectiveness. Based on a patented calculation algorithm, Ekip Power Controller allows a list of loads to be controlled from remote according to the priorities defined by the user. How to order: via ABB Ability Marketplace™ or traditional ordering channels. The hardware accessories must be ordered via traditional ordering channels.

When a solution is purchased via ABB Ability Marketplace™, it must be activated through Ekip Connect 3 installed on a PC using Ekip T&P to scan the trip unit.

These solutions require the installation of hardware components that must be ordered through the traditional ordering channels. For further information, please refer to the specific documentation available on ABB Library (www.abb.com/abblibrary/DownloadCenter/).

New digital experience

Solutions

	Functions included	Hardware accessories
PACKAGES		
Voltage Protections	UV - Undervoltage OV - Overvoltage UV2 – 2nd Undervoltage OV2 – 2nd Overvoltage PS – Phase sequence VU – Voltage unbalance	-
Frequency Protections	UF - Underfrequency OF - Overfrequency UF2 – 2nd Underfrequency OF2 - 2nd Overfrequency	-
Power Protections	RP – Reverse active power Cos Φ - Power factor D – Directional current RQ – Loss of field or Reverse reactive power OQ – Reactive overpower OP – Active overpower UP – Active underpower 2RQ – 2nd Loss of field or Reverse reactive power	-
Advanced Voltage Protections	S(V) – Voltage controlled overcurrent S(V)2 – 2nd Voltage controlled overcurrent R – Residual voltage	-
ROCOF Protections	ROCOF	-
Adaptive Protections	Dual setting	Ekip Signalling
Measuring Package	Phase-to-phase voltage Phase-to-neutral voltage Phase sequence Frequency Active power Reactive power Apparent power Power factor Peak factor	-
Data Logger	Currents Voltages Sampling rate Maximum recording duration Recording stop delay Number of registers	-
Network Analyzer	Hourly average voltage value Short voltage interruptions Short voltage spikes Slow voltage sags and swells Voltage unbalance Harmonic analysis	-

	Functions included	Hardware accessories
BUNDLES		
Intelligent Grid Edge	Measuring Package Adaptive Protections Power Protections Voltage Protections Ekip Power Controller	Ekip Link, Ekip Signalling, motor operators and coils
Power Management	Measuring Package Adaptive Protections Power Protections Voltage Protections	Ekip Signalling
Grid Connection	Measuring Package Adaptive Protections Power Protections Ekip Power Controller	Ekip Link, Ekip Signalling, motor operators and coils
Diagnostics	Measuring Package Network Analyzer Data Logger	-
Measure Advanced	Measuring Package Network Analyzer	-
SOLUTIONS		
Interface Protection System	-	Ekip Link, Ekip Signalling, motor operators and coils
Synchro Reclosing	-	Ekip Link, Ekip Signalling, motor operators and coils
Embedded ATS	-	Ekip Link, Ekip Signalling, motor operators and coils
Adaptive Load Shedding	-	Ekip Link, Ekip Signalling, motor operators and coils
Ekip Power Controller	-	Ekip Link, Ekip Signalling, motor operators and coils

Offer

SACE Tmax XT trip units offer a solution for any installation requirement, from the building sector to industry, from marine purposes to datacenters any need is always satisfied.

The complete, flexible protection trip unit is classified in three different fields of applications as follows:

Power distribution protection

Tmax XT is the ideal solution for all distribution levels, from main low voltage switchboards to sub-switchboards, and also for transformers and drives. The field of application is very broad and ranges from residential and commercial buildings to infrastructure, microgrids, but also industrial environments, oil and gas installations, mining facilities, data centers, marine applications, wind and solar farms. Depending on the complexity of the system, it is possible to select between different performance levels. Thus, when higher protection accuracy is required, or advanced control systems are needed, it is always possible to choose the appropriate version.

Motor protection

Motors are used in several industrial sectors, like food and beverage, chemicals, metallurgic, paper, water and extractive industries.

When a motor system needs to be protected, the safety and reliability of the solution are important aspects that must be considered when choosing and manufacturing the system for motor starting and monitoring.

Start-up is a particularly critical phase for the motor itself and for the system powering it.

When it comes to direct starting, the SACE Tmax XT range proposes different solutions, from magnetic only protection to a very advanced protection system.

Generator protection

Tmax XT has been designed to provide a solution for the protection of small generators and networks where distribution is realized through very long cables. In addition, it also provides protection for generators without using external devices that require dedicated relays and wiring. This solution minimizes the time needed for implementation and commissioning of the system, and ensures the high levels of accuracy and reliability required for running generators in applications such as naval, GenSet or cogeneration.

	Field of application	Current protection	Remote Control	Measurement and protection of current, frequency, voltage power, energy	Embedded software functions
TMF/TMA	Power	●	●		
Ekip Dip	Distribution	●	●		
Ekip Touch		●	●	●	●
MA (MCP)	Motor	●	●		
Ekip M Dip (MCP/MPCB)		●	●		
Ekip M Touch (MPCB)		●	●	●	●
TMG	Generator	●	●		
Ekip G Dip		●	●		
Ekip G Touch		●	●	●	●





Offer

The Tmax XT trip units represent the ideal solution for any application up to 1200A.

The Tmax XT molded case circuit-breaker family complies with numerous installation requirements. Circuit-breakers are available with trip units dedicated to three different application groups. The table below shows the trip units for each circuit-breaker frame and the related rated interrupted current ranges.

The power distribution and generator protection application trip units are available in both 3 and 4-pole versions. With the XT2, XT4, XT5, XT6, XT7 and XT7 M versions the trip units are interchangeable, in order to make a performance upgrade of the system easier.



Rated uninterrupted current ranges [A]	XT1	XT2	XT3
Power Distribution Protection			
Thermal-magnetic			
	TMF	15...125	15...70
	TMA		80...125
Ekip Dip			
	Ekip Dip LS/I	10...125	
	Ekip Dip LIG	10...125	
	Ekip Dip LSI	10...125	
	Ekip Dip LSIG	10...125	
Ekip Touch			
	Ekip Touch LSI	40...125	
	Ekip Touch LSIG	40...125	
	Ekip Touch Measuring LSI	40...125	
	Ekip Touch Measuring LSIG	40...125	
	Ekip Hi-Touch LSI	40...125	
	Ekip Hi-Touch LSIG	40...125	
Motor Protection			
Magnetic			
	MA	3.2...125	3...125
Ekip Dip			
	Ekip M Dip I	10...125	
	Ekip M Dip LIU	25...100	
Ekip Touch			
	Ekip M Touch LRIU	40...100	
Generator Protection			
Thermal-magnetic			
	TMG		
Ekip Dip			
	Ekip G Dip LS/I		
Ekip Touch			
	Ekip G Touch LSIG		
	Ekip G Hi-Touch LSIG		

Maximum flexibility is guaranteed for customers: on the XT5, XT7 and XT7 M, with Ekip Touch trip units, the interchangeable rating plug enables the rated current to be changed according to system requirements.



XT4	XT5	XT6	XT7	XT7 M
25...250				
80...250	300...600	600...800		
40...250	250...600	600...800	600...1200	600...1200
40...250	250...600	600...800	600...1200	600...1200
40...250	250...600	600...800	600...1200	600...1200
40...250	250...600	600...800	600...1200	600...1200
100...250	250...600		600...1200	600...1200
100...250	250...600		600...1200	600...1200
100...250	250...600		600...1200	600...1200
100...250	250...600		600...1200	600...1200
100...250	250...600		600...1200	600...1200
100...250	250...600		600...1200	600...1200
25...200	300...500			
40...250	250...600	600...800	600...1200	600...1200
40...150	250...500	600...800		
100...200	250...500		600...1200	600...1200
	300...600			
	300...600	600...800	600...1200	600...1200
	250...600		600...1200	600...1200
	250...600		600...1200	600...1200

Thermal-magnetic trip unit

Overview

The thermal-magnetic trip units are used for the protection of AC and DC networks. They are a solution for systems where only protection against overloads and short-circuits are needed.

Power Distribution Protection

- TMF
- TMA

Motor Protection

- MA

- Key:
1. Current threshold for short-circuit protection;
 2. Rotary switch for short-circuit protection;
 3. Current threshold for overload protection;
 4. Rotary switch for overload threshold setting.



Rotary switch

Depending on the version, it is possible to set the desired thresholds for protection by turning the front rotary switch.

Field of application	Trip Unit	L - Overload Protection		I - Short-circuit Protection	
		Current Threshold	Trip Time	Current Threshold	Trip Time
Power Distribution Protection	TMF	Fixed	Fixed	Fixed	Fixed instantaneous
	TMA	Adjustable	Fixed	Adjustable	Fixed instantaneous
Motor Protection	MA	-	-	Adjustable	Fixed instantaneous

Power Distribution Protection

TMF

In [A]	15	20	25	30	35	40	45	50	60	70	80	90	100	110	125	150	175	200	225	250	
XT1	●	●	●	●	●	●	●	●	●	●	●	●	●	●	●						
XT2	●	●	●	●	●	●		●	●	●											
XT3									●	●	●	●	●	●	●	●	●	●	●	●	●
XT4			●	●	●	●		●	●	●	●	●	●	●	●	●	●	●	●	●	●

Note: For XT4 and for In ≥ 80A, TMF available in 3 poles version only

TMA

In [A]	80	90	100	110	125	150	175	200	225	250	300	400	500	600	800
XT2	●	●	●	●	●										
XT4	●	●	●	●	●	●	●	●	●	●					
XT5											●	●	●	●	
XT6														●	●

Motor Protection

MA (MCP)

In [A]	3	7	15	25	30	50	70	80	100	110	125	150	175	200	225	250	300	400	500	
XT1	●	●	●		●	●	●	●	●		●									
XT2	●	●	●		●	●	●	●	●		●									
XT3									●	●	●	●		●						
XT4				●		●		●	●	●	●	●	●	●	●	●				
XT5																	●	●	●	

Generator Protection

TMG

In [A]	300	400	500	600
XT5	●	●	●	●

Thermal-magnetic trip unit

Settings

Available settings for TMF and TMA trip units:

Circuit Breaker	Trip Unit	In [A]	L - Overload			I - Short Circuit				
			I1 [A]			I3 [A]				
			MIN.	MED.	MAX.	MIN.	MED.	MAX.		
XT1	TMF	15			15			500		
		20			20			500		
		25			25			500		
		30			30			500		
		35			35			500		
		40			40			500		
		45			45			500		
		50			50			500		
		60			60			600		
		70			70			700		
		80			80			800		
		90			90			900		
		100			100			1000		
		110			110			1100		
125			125			1250				
XT2	TMF	15			15			400		
		20			20			400		
		25			25			400		
		30			30			400		
		35			35			400		
		40			40			400		
		50			50			500		
	60			60			600			
	70			70			700			
	80	56	68	80	400	600	800			
	90	63	77	90	450	675	900			
	100	70	85	100	500	750	1000			
	110	77	94	110	550	825	1100			
	125	88	107	125	625	937	1250			
XT3	TMF	60			60			600		
		70			70			700		
		80			80			800		
		90			90			900		
		100			100			1000		
		110			110			1100		
		125			125			1250		
		150			150			1500		
		175			175			1750		
		200			200			2000		
		225			225			2250		
		XT4	TMF	25			25			400
				30			30			400
				35			35			400
40					40			400		
50					50			500		
60					60			600		
70					70			700		
80					80			800		
90					90			900		
100					100			1000		
110					110			1100		
125					125			1250		
150					150			1500		
175					175			1750		
200				200			2000			
225				225			2250			
250				250			2500			
	TMA		80	56	68	80	400	600	800	
			90	63	77	90	450	675	900	
			100	70	85	100	500	750	1000	
		110	77	94	110	550	825	1100		
		125	88	106	125	625	938	1250		
		150	105	128	150	750	1125	1500		
XT5	TMA	175	123	149	175	875	1313	1750		
		200	140	170	200	1000	1500	2000		
		225	158	192	225	1125	1688	2250		
		250	175	213	250	1250	1875	2500		
		300	210	255	300	1500	2250	3000		
		400	280	340	400	2000	3000	4000		
		500	350	425	500	2500	3750	5000		
XT6	TMA	600	420	510	600	3000	4500	6000		
		800	560	680	800	4000	6000	8000		

Available settings for MA and TMG trip units:

Circuit Breaker	Trip Unit	In [A]	L - Overload I1 [A]			I - Short Circuit I3 [A]		
			MIN.	MED.	MAX.	MIN.	MED.	MAX.
XT1	MA	3				12	23	33
		7				28	53	77
		15				45	105	165
		30				90	210	330
		50				150	350	550
		70				210	490	770
		80				240	560	880
		100				300	700	1100
XT2	MA	125				375	875	1375
		3				12	23	33
		7				28	53	77
		15				45	105	165
		30				90	210	330
		50				150	350	550
		70				210	490	770
		80				240	560	880
XT3	MA	100				600	900	1200
		110				660	990	1320
		125				750	1125	1500
		150				900	1350	1800
		200				1200	1800	2400
XT4	MA	25				75	175	275
		50				150	350	550
		80				400	600	800
		100				500	750	1000
		110				550	825	1100
		125				625	938	1250
		150				750	1125	1500
		175				875	1313	1750
		200				1000	1500	2000
		225				1125	1688	2250
		250				1250	1875	2500
		XT5	MA	300				2100
400						2800	4000	5200
500						3500	5000	6500
600						4200	6000	7800
TMG	300		210	255	300	750	1125	1500
	400		280	340	400	1000	1500	2000
	500		350	425	500	1250	1875	2500
	600		420	510	600	1500	2250	3000

Ekip Dip

Overview

The Ekip Dip is a first level of electronic trip unit, used for the protection of AC networks.

Power Distribution Protection

- Ekip Dip LS/I
- Ekip Dip LIG
- Ekip Dip LSI
- Ekip Dip LSI G

Motor Protection

- Ekip M Dip I
- Ekip M Dip LIU

Generator Protection

- Ekip G Dip LS/I

Key:

1. Dip switches for an overload protection setting.
2. Dip switches for short-circuit and time delayed short-circuit protection settings.
3. Slot for lead seal.
4. Test connector.
5. Power-on LED.

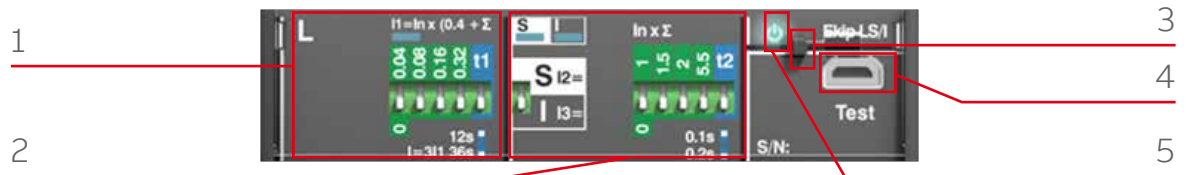

Dip switches

The dip switches on the front of the trip unit allow manual settings also when the trip unit is off.

LEDs

The LEDs on the front indicate the status of the release (on/off) and provide information about the protection tripped when the Ekip TT accessory is connected.

Front connector

The connector on the front of the unit allows the connection of:

- Ekip TT for trip testing; LED-test and signaling of the most recent trip.
- Ekip T&P for connection to a laptop with the Ekip Connect program (thus measurement reading, as well as trip and protection function tests are made available for the user).

Characteristics of electronic Ekip Dip trip units

Operating temperature	-25°C...+70°C
Relative humidity	98%
Self-supplied	0.2xIn (single phase)*
Auxiliary supply (where applicable)	24V DC ± 20%
Operating Frequency	45...66Hz
Electromagnetic compatibility	IEC 60947-2 Annex F

*For 10A:0.4in

Thermal memory

All the Ekip Dip trip units include a thermal memory function. The trip unit records the trips which have occurred in the last few minutes. Since the trip causes overheating, in order to protect the cables and let them cool down, the trip unit imposes a shorter delay tripping time in case of a fault. Thus, the system is protected against damage due to cumulative overheating. This can be disabled, if needed, by using the Ekip T&P.

External neutral

Ekip Dip trip units are available in both 3 and 4 poles. The 3-pole version with earth fault protection (G) can be equipped with an external sensor for the neutral phase. In this way, the external neutral phase is protected and uninterrupted.

Communication

- Using the dedicated Ekip Com module, XT2 and XT4 can communicate with Modbus RTU when they are equipped with the following trip units:
 - Ekip LSI
 - Ekip LSI G.

Field of application	Trip Unit	L - Overload Protection		S - Selective Short-circuit Protection		I - Short-circuit Protection		
		Current Threshold	Trip Time	Current Threshold	Trip Time	Current Threshold	Trip Time	
Power Distribution Protection	Ekip Dip	LS/I	Adjustable	Adjustable	Adjustable	Adjustable	Fixed	
		LIG	Adjustable	Adjustable	-	-	Adjustable	Fixed
		LSI	Adjustable	Adjustable	Adjustable	Adjustable	Adjustable	Fixed
		LSIG	Adjustable	Adjustable	Adjustable	Adjustable	Adjustable	Fixed
Motor Protection	Ekip M Dip I	-	-	-	-	Adjustable	Fixed	
		LIU	Adjustable	Adjustable	-	-	Adjustable	Fixed
Generator Protection	Ekip G Dip	LS/I	Adjustable	Adjustable	Adjustable	Adjustable	Fixed	

Power Distribution Protection

- Ekip Dip LS/I
- Ekip Dip LIG
- Ekip Dip LSI
- Ekip Dip LSIG

In [A]	10	25	40	60	100	125	150	225	250	300	400	600	800	1000	1200
XT2	●	●		●	●	●									
XT4			●	●	●		●	●	●						
XT5									●	●	●	●			
XT6												●	●		
XT7												●	●	●	●

Motor Protection

Ekip M Dip I

In [A]	10	25	40	60	100	125	150	225	250	300	400	600	800	1000	1200
XT2	●	●		●	●	●									
XT4			●	●	●		●	●	●						
XT5									●	●	●	●			
XT6												●	●		
XT7												●	●	●	●

Ekip M Dip LIU

In [A]	25	40	60	100	150	250	300	400	500	600	800
XT2	●		●	●							
XT4		●	●	●	●						
XT5						●	●	●	●		
XT6										●	●

Generator Protection

Ekip G Dip LS/I

In [A]	250	300	400	600	800	1000	1200
XT5	●	●	●	●			
XT6				●	●		
XT7				●	●	●	●

Ekip Dip

Protection settings

Available settings for Ekip Dip trip units:

Ekip DIP LS/I & Ekip DIP LIG

ABB code	Protection Function	Threshold	Trip Time	Trip Curve
L	Overload	$I1 = 0.4...1 \times I_n$ with steps of 0.04	t1 at $3 \times I1 = 12 - 36s$ 12 - 48s for XT7	$t = k/I^2$
S	Selective short-circuit	$I2 = \text{Off} - 1 - 1.5 - 2 - 2.5 - 3 - 3.5 - 4.5 - 5.5 - 6.5 - 7 - 7.5 - 8 - 8.5 - 9 - 10 \times I_n$	t2 = 0.1 - 0.2s at $10 \times I_n$ when $t = k/I2$	t=k t = k or $t = k/I^2$ for XT7
I	Short-circuit	$I3 = \text{Off} - 1 - 1.5 - 2 - 2.5 - 3 - 3.5 - 4.5 - 5.5 - 6.5 - 7 - 7.5 - 8 - 8.5 - 9 - 10 \times I_n$	t3 ≤ 20ms t3 ≤ 30ms for XT7	t=k
G	Earth fault	$I4 = \text{Off} - 0.20 - 0.25 - 0.45 - 0.55 - 0.75 - 0.80 - 1 \times I_n$ $I4 = \text{Off} - 0.2 - 0.3 - 0.4 - 0.6 - 0.8 - 0.9 - 1.0 \times I_n$ for XT7	t4 = 0.1 - 0.2 - 0.4 - 0.8s at $3 \times I_n$ when $t = k/I2$	t=k t = k or $t = k/I^2$ for XT7

Ekip DIP LSI & Ekip DIP LSIG

ABB code	Protection Function	Threshold	Trip Time	Trip Curve
L	Overload	$I1 = 0.4...1 \times I_n$ with steps of 0.02 $I1 = 0.4 - 0.42 - 0.45 - 0.47 - 0.5 - 0.52 - 0.55 - 0.57 - 0.6 - 0.62 - 0.65 - 0.67 - 0.7 - 0.72 - 0.75 - 0.77 - 0.8 - 0.82 - 0.85 - 0.87 - 0.9 - 0.92 - 0.95 - 0.97 - 1 \times I_n$ for XT7	t1 at $3 \times I1 =$ 3 - 12 - 36 - 60s at $3 \times I1$ for XT2-XT4 3 - 12 - 36 - 48s for XT5 3 - 12 - 36 - MAX ⁽¹⁾ for XT6 3 - 12 - 24 - 36 - 48 - 72 - 108 - 144s for XT7	$t = k/I^2$
S	Selective short-circuit	$I2 = \text{Off} - 1 - 1.5 - 2 - 2.5 - 3 - 3.5 - 4.5 - 5.5 - 6.5 - 7 - 7.5 - 8 - 8.5 - 9 - 10 \times I_n$ $I2 = \text{Off} - 0.6 - 0.8 - 1 - 1.5 - 2 - 2.5 - 3 - 3.5 - 4 - 5 - 6 - 7 - 8 - 9 - 10$ for XT7	t2 = 0.05 - 0.1 - 0.2 - 0.4 for XT2-XT4-XT5-XT6 t2 = 0.1 - 0.2 - 0.3 - 0.4 - 0.5 - 0.6 - 0.7 - 0.8 for XT7 at $10 \times I_n$ when $t = k/I^2$	t = k or $t = k/I^2$
I	Short-circuit	$I3 = \text{Off} - 1 - 1.5 - 2 - 2.5 - 3 - 3.5 - 4.5 - 5.5 - 6.5 - 7 - 7.5 - 8 - 8.5 - 9 - 10 \times I_n$ $I3 = \text{Off} - 1.5 - 2 - 3 - 4 - 5 - 6 - 7 - 8 - 9 - 10 - 11 - 12 - 13 - 14 - 15$ for XT7	t3 ≤ 20ms t3 ≤ 30ms for XT7	t=k
G	Earth fault	$I4 = \text{Off} - 0.20 - 0.25 - 0.45 - 0.55 - 0.75 - 0.80 - 1 \times I_n$ $I4 = \text{Off} - 0.2 - 0.3 - 0.4 - 0.6 - 0.8 - 0.9 - 1.0 \times I_n$ for XT7	t4 = 0.1 - 0.2 - 0.4 - 0.8s at $3 \times I_n$ when $t = k/I2$	t=k t = k or $t = k/I^2$ for XT7

(1) t1 MAX for XT6: 42s for XT6 1000 and 72s for XT6 800

Ekip M DIP I

ABB code	Protection Function	Threshold	Trip Time	Trip Curve
I	Short-circuit	$I3 = \text{Off} - 1 - 1.5 - 2 - 2.5 - 3 - 3.5 - 4.5 - 5.5 - 6.5 - 7 - 7.5 - 8 - 8.5 - 9 - 10 \times I_n$	t3 ≤ 15ms for XT4-XT5-XT6 t3 ≤ 20ms for XT4-XT5-XT6 t3 ≤ 30ms for XT7	t=k

Ekip M DIP LIU

ABB code	Protection Function	Threshold	Trip Time	Trip Curve
L	Overload	$I1 = 0.4...1 \times I_n$ with steps of 0.04	Operating Class for XT2-XT4: 3E - 5E - 10E - 20E Operating Class for XT5-XT6: 5E - 10E - 20E - 30E	$t = k/I^2$
I	Short-circuit	$I3 = 6 - 7 - 8 - 9 - 10 - 11 - 12 - 13 \times I_n$	t3 ≤ 15ms for XT5-XT4 t3 ≤ 20ms for XT5-XT4 t3 ≤ 30ms for XT7	t=k
U	Phase loss (IEC 60947-4-1)	ON/OFF	When ON t6 = 2s	t=k

Ekip G DIP LS/I

ABB code	Protection Function	Threshold	Trip Time	Trip Curve
L	Overload	$I1 = 0.4...1 \times I_n$ with steps of 0.04	$t1$ at $3 \times I1 = 3 - 6s$	$t = k/I^2$
S	Selective short-circuit	$I2 = \text{Off} - 1 - 1.5 - 2 - 2.5 - 3 - 3.5 - 4.5 - 5.5 - 6.5 - 7 - 7.5 - 8 - 8.5 - 9 - 10 \times I_n$	$t2 = 0.05 - 0.075 - 0.1 - 0.2$ at $10 \times I_n$ when $t = k/I2$	$t = k$ $t = k$ or $t = k/I^2$ for XT7
I	Short-circuit	$I3 = \text{Off} - 1 - 1.5 - 2 - 2.5 - 3 - 3.5 - 4.5 - 5.5 - 6.5 - 7 - 7.5 - 8 - 8.5 - 9 - 10 \times I_n$	$t3 \leq 20ms$ $t3 \leq 30ms$ for XT7	$t = k$

Tolerances in case of:

- Self-powered trip unit at full power
- 2 or 3 phase supply

Trip Unit	Protection	Trip Threshold	Trip Time
Ekip DIP LS/I Ekip DIP LIG Ekip G Dip LS/I	L	trip between 1.05...1.3 x I1	±10% up to 4xIn ±20% from 4xIn
	S	±10%	XT2-XT4-XT5-XT6: 15% ⁽²⁾ XT7: t=k: ±10% t=k/I2: ±15% up to 4xIn ±20% from 4xIn
	I	±10%	-
	G ⁽¹⁾	±10%	XT2-XT4-XT5-XT6: ±20% XT7: ±15%
Ekip DIP LSI Ekip DIP LSIG	L	trip between 1.05...1.3 x I1	XT2-XT4-XT5-XT6: ±10% up to 4xIn ±20% up to 4xIn XT7: ±10% up to 6xIn ±20% up to 6xIn
	S	±10%	XT2-XT4-XT5-XT6: t=k: ±10% up to 4xIn ±20% up to 4xIn t=k/I2: ±15% t2 >100ms ±20ms t2 ≤100ms XT7: t=k the better of the two data: ±10% or ± 40ms t=k/I2: ±15% up to 6xIn ±20% from 6xIn
	I	±10%	-
	G ⁽¹⁾	XT2-XT4-XT5-XT6: ±10% XT7: ±7%	XT2-XT4-XT5-XT6: ±15% XT7: t=k the better of the two data: ±10% or ± 40ms t=k/I2: ±15% up to 6xIn ±20% from 6xIn
Ekip M Dip I and Ekip M Dip LIU	L	trip between 1.05...1.2xI1	±10% up to 4xIn ±20% up to 4xIn
	I	±10%	-
	U	±10%	±10%

Note: When the trip unit is used at 400Hz the tripping time tolerance is +/- 25%

(1) G protection is inhibited for currents higher than: - 2xIn with XT2 and XT4
- 4xIn with XT5 and XT6

(2) for G Dip LS/I: - ±10% t2 > 100ms
- ±20% t2 ≤ 100ms

Ekip Dip

Protection settings

Tolerances in other conditions:

Trip Unit	Protection	Trip Threshold	Trip Time
Ekip DIP LS/I	L	trip between 1.05...1.3 x I1 according IEC 60947-2	±20%
Ekip DIP LIG	S	±10%	±20%
Ekip G Dip LS/I	I	±15%	≤60ms
	G	± 30% For In=10A Ifault min=4A For In=25A Ifault min=9A	± 20% For In=10A,25A: ±30%
Ekip DIP LSI	L	trip between 1.05...1.3 x I1 according IEC 60947-2	±20%
Ekip DIP LSIG	S	±10%	±20%
	I	±15%	≤60ms
	G	XT2-XT4-XT5-XT6 ± 30% For In=10A Ifault min=4A For In=25A Ifault min=9A XT7 ± 7%	XT2-XT4-XT5-XT6 ± 20% For In=10A,25A: ±30% XT7 t=k the better of the two data: ±10% or ±40ms t=k/I2: ± 15%
Ekip M Dip I	L	trip between 1.05...1.2xI1	±20%
Ekip M Dip LIU	I	±15%	≤60ms
	U	±20%	±20%

Ekip Touch/Hi-Touch

Overview

The Ekip Touch/Hi-Touch provide a complete series of protections and high accuracy measurements of all electrical parameters and can be integrated perfectly with the most common automation and supervision systems.

Power Distribution Protection

- Ekip Touch LSI
- Ekip Touch LSIG
- Ekip Touch Measuring LSI
- Ekip Touch Measuring LSIG
- Ekip Hi-Touch LSI
- Ekip Hi-Touch LSIG

Motor Protection

- Ekip M Touch LRIU

Generator Protection

- Ekip G Touch LSIG
- Ekip G Hi-Touch LSIG

Key:

1. Power-on LED; pre-alarm LED; alarm LED
2. Test and programming connector
3. Display
4. Home push-button to return to homepage;
5. Push-button for testing and tripping information



Communication and Connectivity

The Ekip Touch/Hi-Touch trip units can be integrated perfectly into all automation and energy management systems to improve productivity and energy consumption and for remote control. The circuit-breakers can be equipped with communication modules for Modbus, Profibus, and DeviceNet™ protocols as well as Modbus TCP, Profinet, EtherNet/IP™ and Open ADR. The modules can be easily installed even at a later date.

A solution with integrated modules is useful when the space in the switchboard is limited, but also a solution with external Ekip Cartridge modules is highly suitable when an advanced control and communication system is required.

Furthermore, the IEC61850 communication module enables connection to automation systems widely used in medium voltage power distribution to create intelligent networks (Smart Grids). All circuit-breaker functions are also accessible via the Internet, in complete safety, through the Ekip Link switchgear supervision system and the Ekip Control Panel. Furthermore, with an easy connection thanks to the Ekip Com Hub module, the circuit-breakers allow the system to be monitored via ABB Ability™ EDCS.

Ekip Touch/Hi-Touch

Overview

Efficiency and measurements

Achieving maximum efficiency for an electrical installation requires intelligent management of power supplies and energy use. For this reason, the new technologies used in the Ekip Touch/Hi-Touch trip units allow the productivity and reliability of installations to be optimized while reducing consumption and fully respecting the environment. These advanced functionalities, together with the protection and communication functions contribute to make Tmax XT with Ekip Touch/Hi-Touch the circuit-breaker that maximizes efficiency in all low-voltage electrical installations. With 1% accuracy on power and energy measurements, the trip units are certified according the IEC 61557-12 Standard. Ekip Touch/Hi-Touch trip units are no longer simply protection devices, but integrate multimeter and network analyzer functionality, thus guaranteeing a top level energy management system.

Digital Upgrade

Ekip Touch/Hi-Touch trip units are available in different versions, to enable a wide range of functions: from the Ekip Touch to the Ekip Hi-Touch, it is always possible to customize any device thanks to the additional digital modules.

All functions are available on the ABB Ability Marketplace™ and can be added both when ordering the trip unit as well as after the installation of the circuit-breaker. Ekip Connect provides the desired functions, and EPiC makes the operation even faster, directly from a Smartphone. Several packages are available to download, and all of them are designed to save time, costs, and space, since no external devices are needed.

Interface

It is possible to interact with the trip unit in several ways via:

- **The front display**

An LCD display with a push button ensures easy navigation on the XT2 and XT4, while a color touch screen is available for intuitive and quick navigation on the XT5 and XT7, together with the possibility of viewing the waveform for different parameters.

- **Smartphone via Bluetooth**

Thanks to the integrated Bluetooth functionality, it is possible to set and check all the measurements and information directly from a smartphone thanks to the EPiC app. Even when the cabinet door is closed, it is always possible to carry out maintenance in a safer way.

- **PC with Ekip Connect**

It is also easy to interact with the trip unit with a PC. Thanks to the Ekip T&P cable the trip unit can be easily connected to a USB PC port and using the Ekip Connect program it is possible to fully interact with the trip unit.

Supply

The Ekip Touch/Hi-Touch protection trip unit is self-supplied through the current sensors and does not require an external supply for the basic protection functions or for the alarm indication functions. The trip units for all the circuit-breakers start to power on from a minimum of $0.2 \times I_n^*$ and activate the indication functions, the ammeter and the display. All protection settings are stored in a non-volatile memory that maintains the information, even without a power supply. An auxiliary supply can also be easily connected. In fact, the trip unit can be supplied by means of a galvanically isolated 24V DC auxiliary voltage with the following characteristics:

Parameter	Operation limits
Voltage	24 V DC galvanically isolated*
Tolerance	±10%
Maximum wave	±5%
Maximum surge current @ 24 V	10 A for 5 ms
Maximum rated power @ 24 V	4 W
Connecting cable	Insulated with ground cable (characteristics equal to or greater than Belden 3105A/B)

The the insulation characteristics must refers to the IEC 60950 (UL 1950) or their equivalent

The Ekip Supply module can be connected to both DC and AC current power supplies to activate additional functions such as:

- using the unit with the circuit-breaker open;
- using additional modules such as Ekip Signalling and Ekip Com;
- connection to external devices such as Ekip Multi-meter and Ekip Control Panel;
- recording the number of operations;
- G protection with values below 100A or below $0.2 \times I_n^*$;
- zone selectivity;
- Gext and MCR protection functions.

Supply	Ekip Supply	
Nominal voltage	24-48 V DC	110-240 V AC/DC
Voltage range	21.5-53 V DC	105-265 V AC/DC
Rated power (including modules)	10W max.	10W max.
Inrush current	~10A for 5 ms	~10A for 5 ms

The Ekip Touch/Hi-Touch are also supplied with a battery that enables the cause of the fault to be indicated after a trip. In addition, the battery enables the date and time to be updated, thus ensuring the chronology of events. When the Ekip Touch/Hi-Touch are active, they use an internal control circuit to automatically indicate that the battery is flat. Furthermore, when the unit is switched off a battery test can be run by simply pressing the iTest key.

* for XT2 and XT4 with $I_n \leq 100A$: $0.3 \times I_n$

Ekip Touch/Hi-Touch

Overview

Rating Plug

The XT5 and XT7 trip units allow the rated current to be modified by simply changing the front rating plug. Thus, an upgrade of the circuit-breaker, whenever needed, can be carried out without replacing the circuit-breaker.

Commissioning

The setting, testing and downloading of reports can be carried out directly from a smartphone, tablet or PC. In addition, the commissioning stage can be further accelerated, minimizing the possibility of errors, by directly configuring the protection trip unit with the DOC design software settings.

Test function

The test port and the iTest key on the front of the protection unit can be used to carry out circuit-breaker tests by connecting one of the following devices:

- The Ekip TT, which allows trip tests, LED tests and checks for the absence of alarms detected by the watchdog function;
- The Ekip T&P, which permits not only trip tests and LED tests but also testing of the individual protection functions and the saving of the relative report;
- The iTest key, to run a battery test when the circuit-breaker is disconnected.

The following table shows the main features for each version of the trip unit. The additional features can be added to the trip unit at the time of purchase or after, via the ABB Ability Marketplace™.

Trip Unit	Current measurement & protection	Voltage, power, energy measurements	Voltage, power, energy protections	Embedded functions*
Ekip Touch LSI	●	○	○	○
Ekip Touch LSIG	●	○	○	○
Ekip Touch Measuring LSI	●	●	○	○
Ekip Touch Measuring LSIG	●	●	○	○
Ekip Hi-Touch LSI	●	●	●	●
Ekip Hi-Touch LSIG	●	●	●	●
Ekip M Touch LRIU	●	●	●	●
Ekip G Touch LSIG	●	●	●	●
Ekip G Hi-Touch LSIG	●	●	●	●

● Default available

○ Additionable features

* See the following pages for more details

Watchdog

All the Ekip Touch/Hi-Touch trip units for the Tmax XT ensure high reliability thanks to an electronic circuit that periodically checks the continuity of the internal connections, such as the trip coil, rating plug and each current sensor (ANSI 74). In the event of an alarm, a message is shown on the display, and if it is set during the installation phase, the trip unit can command the opening of the circuit-breaker. If a protection function intervenes, Ekip Touch/Hi-Touch always checks that the circuit-breaker has been opened by auxiliary contacts that indicate the position of the main contacts. Otherwise, Ekip Touch/Hi-Touch indicate an alarm (ANSI BF code Breaker Failure) to command the opening of the circuit-breaker upstream. Ekip Touch/Hi-Touch also feature self-protection, which ensures the correct operation of the unit in overtemperatures (OT) inside the protection trip unit.

The following indications or controls are available:

- “Warning” LED for temperature below -20 °C or above +70 °C, at which point the trip unit operates correctly with the display switched off.
- “Alarm” LED for temperature outside the operating range, at which point the trip unit commands the opening of the circuit-breaker (if set during the configuration phase).

Power Distribution Protection

- Ekip Touch LSI
- Ekip Touch LSIG
- Ekip Touch Measuring LSI
- Ekip Touch Measuring LSIG
- Ekip Hi-Touch LSI
- Ekip Hi-Touch LSIG

In [A]	40	60	100	125	150	225	250	300	400	600	800	1000	1200
XT2	●	●	●	●									
XT4			●		●	●	●						
XT5							●	●	●	●			
XT7										●	●	●	●

Motor Protection

- Ekip M Touch LRIU

In [A]	40	60	100	150	225	250	300	400	500	600	800	1000	1200
XT2	●	●	●										
XT4			●	●	●								
XT5						●	●	●	●				
XT7										●	●	●	●

Generator Protection

- Ekip G Touch LSIG
- Ekip G Hi-Touch LSIG

In [A]	250	300	400	600	800	1000	1200
XT5	●	●	●	●			
XT7				●	●	●	●

Ekip Touch/Hi-Touch

Protection functions

The Ekip Touch/Hi-Touch trip units enable all the protection functions to be set with a few simple steps.

Thanks to the ABB Ability Marketplace™, it is always possible to customize the Ekip Touch/Hi-Touch trip units when ordering and also when the circuit-breaker is already installed by using the Ekip Connect 3.

Each trip unit has a default protection set, as shown in the table below. Adding other functional packages to this set is always possible, either directly when ordering the circuit-breaker, or via ABB Ability Marketplace™ at a later time.

The following protection software packages are available to be added to any version of Ekip Touch/Hi-Touch trip units:

- Voltage Protection
- Voltage Protection Advanced
- Frequency Protection
- Power Protection
- ROCOF Protection
- Adaptive Protection

ABB Code	ANSI Code	Function	Ekip Touch LSI	Ekip Touch LSI ^G	Ekip Touch Measuring LSI
Default Protection					
L	49	Overload	●	●	●
S	50 TD / 68 / 51	Selective short circuit	●	●	●
I	50	Instantaneous short-circuit	●	●	●
G	50N/50N TD/68/51N	Earth Fault		●	
N		Neutral	●	●	●
2I	50	2nd instantaneous short-circuit	●	●	●
MCR		Closing on short-circuit	●	●	●
linst		Instantaneous high intensity short-circuit protection	●	●	●
IU	46	Current unbalance	●	●	●
Harmonic Distortion			●	●	●
T		Temperature	●	●	●
Hardware trip			●	●	●
Current Thresholds			●	●	●
S2	50 TD/68	2nd Time delayed overcurrent	●	●	●
Voltage Protection package					
Phase Sequence	47	Cyclical direction of the phases	○	○	○
UV	27	Undervoltage	○	○	○
OV	59	Overvoltage	○	○	○
UV2	27	2nd Undervoltage	○	○	○
OV2	59	2nd Overvoltage	○	○	○
VU	47	Voltage unbalance	○	○	○
Voltage Protection Advanced package					
S(V)	51V	Voltage controlled overcurrent	○	○	○
S(V) 2nd	51V	2nd Voltage controlled overcurrent	○	○	○
RV	59N	Residual overvoltage	○	○	○

● Available as standard

○ Available as software package to be ordered via ABB Ability Marketplace™ or during the circuit-breaker ordering phase. To add this function, the Measuring package must be installed first.

Ekip Touch Measuring LSIG	Ekip Hi-Touch LSI	Ekip Hi-Touch LSIG	Ekip M Touch LRIU	Ekip G Touch LSIG	Ekip G Hi-Touch LSIG
●	●	●		●	●
●	●	●	●	●	●
●	●	●	●	●	●
●		●	●	●	●
●	●	●		●	●
●	●	●	●	●	●
●	●	●	●	●	●
●	●	●	●	●	●
●	●	●	●	●	●
●	●	●	●	●	●
●	●	●	●	●	●
●	●	●	●	●	●
●	●	●	●	●	●
●	●	●	●	●	●
●	●	●	●	●	●
○	●	●	●	●	●
○	●	●	●	●	●
○	●	●	●	●	●
○	●	●	●	○	●
○	●	●	●	○	●
○	●	●	●	●	●
○	○	○	○	●	●
○	○	○	○	○	●
○	○	○	○	●	●

Ekip Touch/Hi-Touch

Protection functions

ABB Code	ANSI Code	Function	Ekip Touch LSI	Ekip Touch LSIG	Ekip Touch Measuring LSI
Frequency Protection package					
UF	81L	Underfrequency	○	○	○
OF	81H	Overfrequency	○	○	○
UF2	81L	2nd Underfrequency	○	○	○
OF2	81H	2nd Overfrequency	○	○	○
Power Protection package					
RP	32R	Reverse active power	○	○	○
Cos φ	78	Power Factor	○	○	○
D	67	Directional overcurrent	○	○	○
RQ	40/32R	Loss of field or reverse reactive power	○	○	○
OQ	320F	Reactive overpower	○	○	○
OP	320F	Active overpower	○	○	○
UP	32LF	Active underpower	○	○	○
ROCOF Protection package					
ROCOF	81R	Rate of change of frequency	○	○	○
Adaptive Protection package					
Set A-B		Dual Setting	○	○	○
Motor Protection					
L		Motor protection overload			
R	51LR	Rotor blockage			
U	46	Phase lack and/or unbalance			
Un		Phase unbalance			
Uc	37	Undercurrent			
Protection with additional modules					
SC	25	Synchrocheck	●	●	●
Ekip Ci		Motor contactor interface protection			
PTC		PTC for temperature			
G ext	50G TD/86/51G	Earth fault	● ⁽¹⁾	● ⁽¹⁾	● ⁽¹⁾
Rc	64 50N TD 87N	Residual current / Differential ground fault	● ⁽¹⁾	● ⁽¹⁾	● ⁽¹⁾

● Available ○ Available with the corresponding software package

(1) Available with additional module for XT7 and XT7 M only

When an Ekip Touch LSI or LSIG trip unit is upgraded with one of the following packages:

- Voltage Protection
- Voltage Protection Advanced
- Frequency Protection
- Power Protection
- ROCOF Protection

it is mandatory to add first the Measuring package described on the following pages.

Ekip Touch/Hi-Touch

Protection functions

The Ekip Touch/Hi-Touch can be customized with the protection functions required.

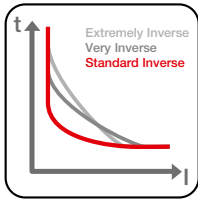

L – Overload (L - ANSI 49)

This function is used for protection against overloads. It allows the setting of the trip threshold, trip time and pre-alarm threshold. Three different types of trip curves are available:

1. $t = k/I^2$ with an inverse long time;
2. IDMT in accordance with IEC 60255-151 for coordination with medium voltage protection, available according to Standard Inverse (SI), Very Inverse (VI) and Extremely Inverse (EI) curves;
3. With a $t = k/I4$ curve for better coordination with upstream circuit-breakers or fuses.

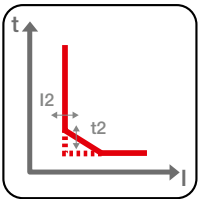

S – Time-delayed overcurrent (S - ANSI 51 & 50TD)

This function is used to protect against selective short-circuits. If necessary, it can be disabled, or if needed, only the trip can be excluded keeping the alarm indication, to be used in installations where continuity of service is required. With a constant trip time ($t = k$), or constant specific let through energy ($t = k/I^2$).

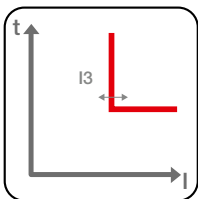

I – Short-circuit

This function is used for instantaneous protection against short-circuits. The trip threshold is adjustable and, if needed, the protection can be disabled.

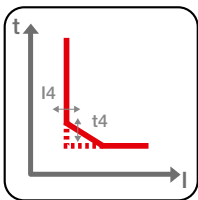

G - Ground fault

This function protects against earth faults. The trip threshold and trip time are adjustable. When needed, the protection can be disabled.

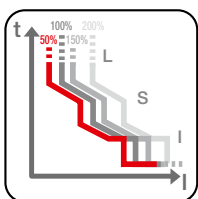

Neutral protection

This function is used to adjust the setting provided from protections L, S and I on the Neutral pole with a control factor which is different from the other phases. It is available with values at 50%, 100%, 150% or 200% of the phase currents. It can be disabled if necessary.

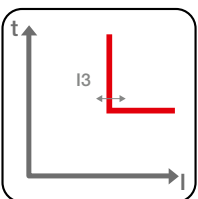

2I - Second protection against instantaneous overcurrent

This function protects against the instantaneous short-circuit (e.g. I protection) and it is enabled with an activation event (or command), that can be programmed by the user. It can be activated for different uses in three ways:

- locally, directly on the Ekip display unit
- locally, with a smartphone with the EPiC app via Bluetooth
- locally, with a PC with the Ekip Connect program
- remotely, via any Ekip Com module connected to the circuit-breaker
- remotely, via a switch wired through an Ekip Signalling module.

When active, the Ekip display unit will show a confirmation of the activation and a red LED alarm will flash on the diagnosis bar.

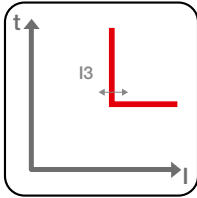

MCR – Closing on Short-circuit

This protection uses the same algorithm as the I protection, limiting the operation to a settable time window starting from the closing of the circuit-breaker. The protection can be disabled, when needed. The function is active with an auxiliary supply.

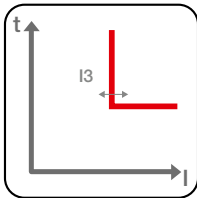

linst

This guarantees the integrity of the circuit-breaker and installation in the case of particularly high current values requiring shorter reaction times than those provided by the instantaneous short-circuit protection. The protection cannot be disabled, and the tripping threshold and time are defined by ABB.

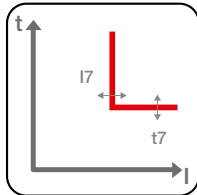

IU - Current unbalance (ANSI 46)

This function protects against an unbalance between the currents of the single phases protected by the circuit-breaker.

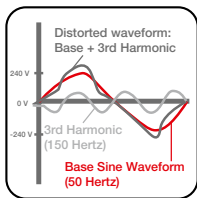

Harmonic distortion

This allows a control alarm to be activated for a distorted waveform. If enabled, an alarm is activated for waveform factors higher than 2.1.

T - Temperature

This protects the circuit-breaker against abnormal temperatures recorded by the unit. It is always active, and has two states, according to the temperature:

- Warning: $-25 < t < -20$ or $70 < t < 85$ Display off; Warning LED on @ 0.5Hz.
- Alarm: $t < -25$ or $t > 85$ Display off; Alarm and Warning LEDs on @2Hz; Circuit-breaker opening command.

Hardware Trip

This protects against internal disconnections of the circuit-breaker. If enabled, a fault is signaled and an opening command is sent if one or more of the following events are detected:

- Current sensors disconnected (phase or external if enabled)
- Rating plug disconnected (only for XT5 and XT7)
- Trip coil disconnected (only signaling)
- Incompatibility between protection release and mainboard (only for XT7)
- Internal problems with the release.

Current thresholds

This function enables the realization of four independent thresholds to be indicated to enable corrective actions before the overload L protection trips the circuit-breaker. For example, by disconnecting the loads controlled by an Ekip Signalling device positioned downstream of the circuit-breaker.

Ekip Touch/Hi-Touch

Protection functions

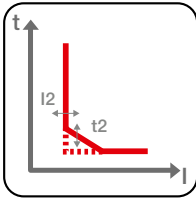

S2 - Second time-delayed overcurrent protection

In addition to the Standard S protection, a second (excludible) time-constant protection is available that enables two independent thresholds to be set to ensure precise selectivity, especially under highly critical conditions.

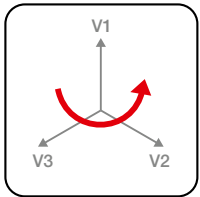

Phase sequence

This trips in case of an inversion of the phase sequence.

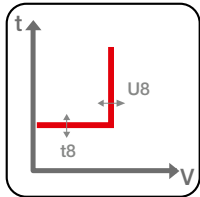

UV - Undervoltage (UV - ANSI 27)

With a constant trip time ($t = k$), this trips when the phase voltage falls below the set threshold.

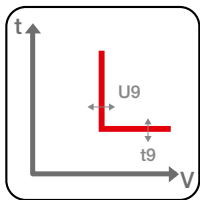

OV - Overvoltage (OV - ANSI 59)

With a constant trip time ($t = k$), this trips when the phase voltage exceeds the set threshold.

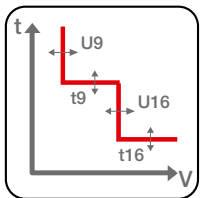

UV2 & OV2 - Second protection against undervoltage and overvoltage (ANSI 27 and 59)

This enables two minimum and maximum voltage thresholds to be set with different delays to discriminate, for example, between voltage dip transients due to the start-up of a motor and an actual fault.

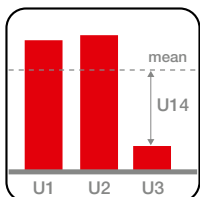

VU - Voltage unbalance (VU - ANSI 47)

With a constant trip time ($t = k$), this protects against an unbalance between the voltages of the single phases that are protected by the circuit-breaker.

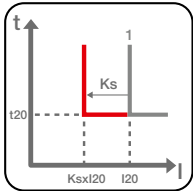

S(V) - Voltage controlled overcurrent protection (ANSI 51V)

This provide protection from a maximum current with a constant trip time ($t = k$) that is sensitive to the voltage value. Following a voltage drop, the current set threshold decreases in steps or linearly. It is possible to set the operating mode to: active, alarm only, or deactivated. The protection operates also with the circuit-breaker open, thus allowing fault identification before circuit-breaker closing.

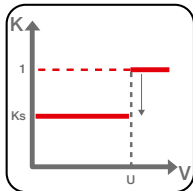

In step mode (controlled mode) the protection is tripped at a set threshold (I_{20}) if the voltage is above U , whereas it is tripped at the lower threshold of the factor K_s ($I_{20} * K_s$) if the voltage is below U .

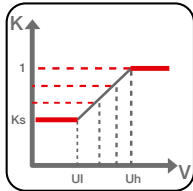

In linear mode (restrained mode) two voltage limits are selected within which the protection is tripped at the set threshold (I_{20}) reduced by a factor of K corresponding to the measured voltage. The variation of the factor K is proportional to the voltage, and for voltages greater than the upper threshold (U_h) the threshold I_{20} works, whereas for voltages below the lower threshold (U_l) the minimum threshold ($I_{20} * K_s$) applies.

S2(V) – 2nd protection against voltage-controlled overcurrent protection (ANSI 51V)

Available in addition to the protection $S(V)$, this enables total selectivity to be achieved in all installations. It is possible to set the operating mode to: active, alarm only, or deactivated. The protection also operates with the circuit-breaker open, thus allowing fault identification before circuit-breaker closing.

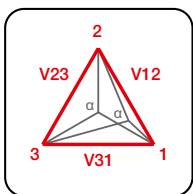

Residual overvoltage (ANSI 59N)

With a constant trip time ($t = k$), this protects against insulation loss in systems with insulated neutral or with neutral earthed with impedance. It is possible to set the operating mode to: active, alarm only, or deactivated. The protection also operates with the circuit-breaker open, thus allowing fault identification before circuit-breaker closing.

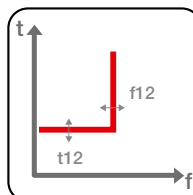

UF Underfrequency (ANSI 81L)

With a constant trip time ($t = k$), this trips when the network frequency falls below a set threshold.

Ekip Touch/Hi-Touch

Protection functions

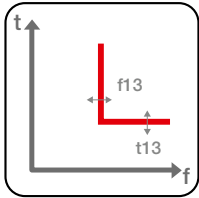

OF Overfrequency (ANSI 81H)

With a constant trip time ($t = k$), this trips when network frequency exceeds a set threshold.

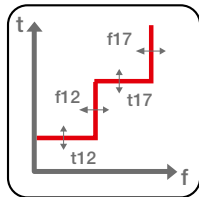

UF2 & OF2 Second protection against underfrequency and overfrequency (ANSI 81L and 87H)

This enables two minimum and maximum frequency thresholds to be set simultaneously. For example, just an alarm can be set for tripping when the first threshold is reached, and the circuit-breaker can be set to be opened when the second threshold is reached.

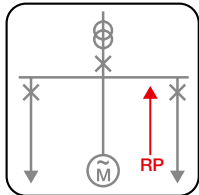

RP Reverse active power

With a constant trip time ($t = k$), this trips when the total active power – in the opposite direction of the current exceeds the set threshold.

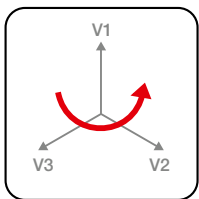

Cos ϕ Power factor

Available with a three-phase threshold, this provides a warning when the system operates with a power factor that is lower than the set power factor.

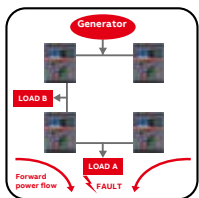

D Directional overcurrent

This form of protection is able to recognize the direction of the current during the fault period and thus detect if the fault is upstream or downstream of the circuit-breaker. The protection, with a fixed time trip curve ($t=k$), intervenes with two different time delays ($t7bw$ and $t7fw$), according to the current direction. In ring distribution networks, it enables the identification and disconnection of the area in which a fault has occurred, while maintaining operation in the rest of the installation.

Zone selectivity for protection D (ANSI 68)

This enables the possibility to interconnect more circuit-breakers, so that, in case of a fault, the affected area can be disconnected nearest to the fault and operation in the rest of the installation is maintained. It is possible to enable directional zone selectivity alternatively to zone selectivity of S and G protections. This also works in the presence of an auxiliary supply.

Start-up function for protection D

This enables higher trip thresholds to be set at the outgoing point, as available for protections S, I and G.

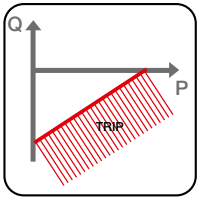

RQ Loss of field or reverse reactive power (ANSI 40 or 32RQ)

With a constant trip time ($t = k$) this circuit-breaker trips when the total reactive power absorbed by the generator exceeds the set threshold. It is possible to select a constant threshold ($k=0$) or a function of the delivered active power of the generator ($k \neq 0$).

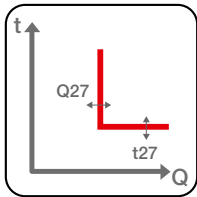

OQ Reactive overpower (ANSI 32OF):

With a constant trip time ($t = k$), this trips when the reactive power exceeds the set threshold in the direction from the generator to the network.

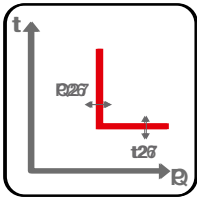

OP Active overpower (ANSI 32OF):

With a constant trip time ($t = k$), this trips when the active power exceeds the threshold set in the delivering direction from the generator.

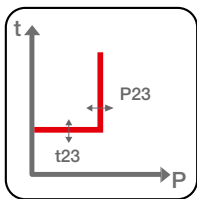

UP Active underpower (ANSI 32LF):

With a constant trip time ($t = k$), this trips when the active power delivered by the generator is lower than the set threshold. It is possible to disable the protection temporarily to manage the start-up phase by setting a time window from the closing of the circuit-breaker, by using an electric signal or via incoming communication to a relay.

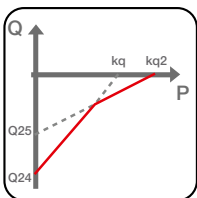

RQ2 Second protection against loss of field or reverse reactive power (ANSI 40 or 32R):

This functions as the above mentioned RQ protection. These two functions can be active and used at the same time, thus allowing the under-excitation curve of the generator to be accurately followed and avoiding unwanted disconnections.

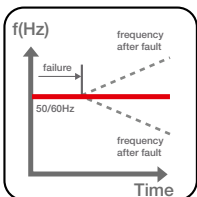

ROCOF Rate of change of frequency (ANSI 81R)

This enables both positive and negative frequency variations to be detected rapidly. The threshold is constant and the function trips when the frequency variation in Hz/s is greater than the set threshold. It is possible to set the operating mode to: active, alarm only, or deactivated. The protection enables the identification and disconnection of the area where the fault has occurred while maintaining operation in the rest of the installation.

Ekip Touch/Hi-Touch

Protection functions

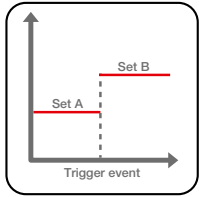

Adaptive protection: dual setting of protections (Set A-B)

The Ekip Hi-Touch can store a set of alternative parameters (set B) for all protections. This second set can replace the default series (set A) with an external control. A typical application for dual settings may be when an emergency source is activated in the system, causing a change of load capacity and short-circuit levels, and in cases of switchgear maintenance to protect the operator against electric arcs (the minimum trip delays of set B guarantee safety for the operator). It is possible to activate series B by:

- Digital input, available with an Ekip Signalling module;
- Communication network, by means of one of the Ekip Com communication modules;
- Directly from the Ekip Hi-Touch display;
- Using a settable internal time, after the circuit-breaker has closed.

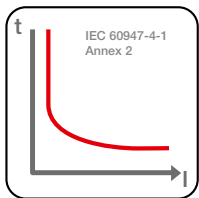

L Motor protection overload in compliance with Standard IEC 60947-4-1 Annex 2

The L function protects the motor against overloads in accordance with the indications and classes defined by Standard IEC 60947-4-1 and the Annex 2. The trip time is established by choosing the appropriate trip class, which depends on the motor that must be protected. In addition to this protection, the thermal memory function (implemented in accordance with Standard IEC60255-8 and the above-mentioned Standard) is permanently activated. After tripping the Ekip M Touch LRIU, the thermal memory is active for a time that depends on the trip class selected (see table). The protection unit will trip faster than the time established for a cold fault condition if a new overload occurs before the thermal memory automatically resets (hot trip condition). The protection has a “start-up” stage from the moment the current exceeds $0.25 \times I_n$ to the moment the minimum time of the selected trip class is reached.

TRIP CLASS	CLASS MIN	CLASS MAX	TMEM RESETTING TIME
5E	3s	5s	5 min
10E	5s	10s	10 min
20E	10s	20s	20 min
30E	20s	30s	33 min

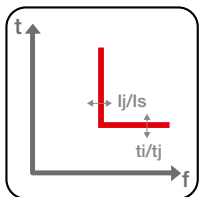

R Protection against rotor blockage

This protects the motor in two different ways, depending on whether the fault occurs on startup or during normal operation. The behavior in the two operating conditions is defined by the Standard IEC 947-4-1 in Annex 2. In the first case (Jam), the operation of the R function protects the motor against rotor jamming during normal operation. The R (Jam) protection function works in conjunction with the L protection to ensure that the motor start-up phase is completed. The R (Jam) protection is inhibited during the start-up phase for the same time as the minimum time in the selected overload protection trip class. Once this time has elapsed, the R protection is activated and causes the circuit-breaker to trip if the current remains above the current threshold setting (I_5) for longer than the time (t_5) setting of the protection. In the second case (Stall), the protection is designed to operate to protect the motor against rotor jamming upon start-up. If activated, the R (Stall) protection is not inhibited during start-up and causes the circuit-breaker to open if the current remains above the current threshold setting (I_8) for longer than the time setting (t_8) of that protection. The protection has a “start-up” stage from the moment the current exceeds $0.25 \times I_n$ to the moment the minimum time of the selected trip class is reached.

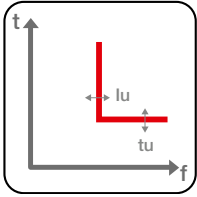

U Protection against phase loss and/or unbalance

This can be implemented when the motor must be promptly protected owing to the absence of a phase. The protection trips if the r.m.s. value of at least one of the phase currents drops below the level equal to 0.1 times the rated current of the trip unit and a second phase exceeds 0.25 times the rated current.

The circuit-breaker is opened if the current value fails to rise above this level within 2 sec. During start-up, the tripping time of the protection is the lowest value between 2 sec or half the minimum time of the start-up class. The protection has a “start-up” stage starting from the moment the current exceeds $0.25 \times I_n$ to the moment the minimum time of the selected trip class is reached.

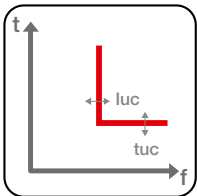

UC Undercurrent protection

This function protects the motor from operating in conditions where the load is reduced or null. The circuit-breaker is opened if all the phases remain below the threshold setting I_9 for delay-time t_9 . The protection has a “start-up” stage from the moment the current exceeds $0.25 \times I_n$ to the moment the minimum time of the selected trip class is reached.

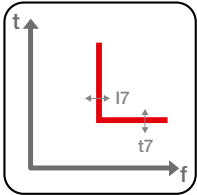

IU Protection against phase unbalance

This unit is used when a motor needs to be protected against differences in the currents circulating in the phases. Threshold setting I_7 defines the maximum level of difference between each phase and the mean value of the three phases. If a phase differs more than its set level from the mean value, the protection opens the circuit-breaker once its time-delay setting (t_7) has elapsed. The protection is activated only if all three phase currents exceed $0.25 \times I_n$. During the start-up phase, the tripping time is the lowest value between t_7 or half the minimum time of the start-up class. The protection has a “start-up” stage from the moment the current exceeds $0.25 \times I_n$ to when the minimum time of the selected trip class is reached.

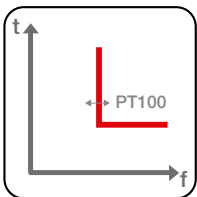

PTC Temperature protection

In its initial configuration, this trip unit is set up to receive an incoming signal from a PTC sensor installed on the motor. The operating thresholds of the protection are defined in accordance with the Standard IEC 60947-8. If the threshold is exceeded, the trip unit opens the circuit-breaker after a 1 sec time-delay.

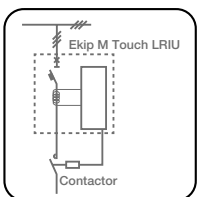

Ekip CI Contactor Interface for motor protection

The breaking capacity of a contactor is definitely lower than a circuit-breaker, but with a number of possible operations consistently higher than those of the breaker (approx. 1,000,000): motor protection and operation are thus optimized when these two devices are used in conjunction with each other. In its initial configuration, the trip unit is set for operation in Normal mode, activating the contactor by means of the Ekip CI module if one of the protections trip (with the exception of protections I and G).

If the configuration is changed from Normal to Heavy, the trip unit opens the circuit-breaker directly without transmitting the command to the contactor. An auto-reset function allows the actuation status of the Ekip CI to reset automatically after the contactor has tripped owing to the L function, once an adjustable time from 1 to 1000s has elapsed. Auto-reset can occur only in Normal mode. A BACK UP function is also available and deals with situations where an opening command transmitted to the contactor via module Ekip CI has not been successful. In this case, the EKIP M Touch LRIU trip unit sends an opening command to the circuit-breaker after waiting for the set time T_x . The actuation time of the contactor given by the manufacturer must be considered when the time-delay setting T_x is entered. The function is active with an auxiliary supply.

Ekip Touch/Hi-Touch

Protection functions

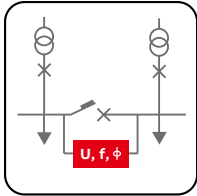

SC Synchrocheck

By comparing voltage, frequency and phase values of the two circuits involved, the synchronism control function indicates that the synchronism conditions necessary to allow the circuit-breaker to be closed have been reached. The function is available in two operating modes:

- In systems with both busbars supplied, where synchronism is determined by:

1. the voltage of the two half-busbars above the U_{live} threshold for the set time
2. the difference of the two voltages below the threshold ΔU
3. the difference of the frequency of the two voltages below the threshold Δf
4. the difference of the phase of the two voltages below the threshold Δ
5. the desirable time for synchronism condition t_{syn}
6. the circuit-breaker.

- In systems with an out-of-service line (dead busbar), where the synchronism condition is determined by the concurrence of the following conditions for the set t_{Ref} time:

1. the voltage of the active half-busbar is above threshold U_{live}
2. the voltage of the dead half-busbar is below threshold U_{dead}
3. the circuit-breaker is open.

In both cases, the synchronism signal is activated when the required conditions are reached and it remains active for at least 200ms. After this lapse of time, the consent signal is deactivated, if the synchronism conditions fail.

The indication of the synchronism reached is available directly as an electrical indication via a contact that is always provided with the module. This function can be activated simply by connecting the Ekip Synchrocheck module to any Ekip Touch device provided with an Ekip Measuring module.

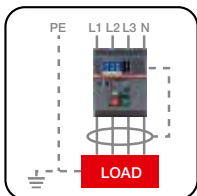

G ext – Ground fault on toroid

This is available only for the XT7, with a trip time which is independent of the current ($t = k$) or with a constant specific let-through energy ($t = k/I^2$). If the pre-alarm reaches a 90% threshold this permits the fault to be reported to supervision systems without any interruption of continuity. The protection needs an external toroid installed, for example, on the star center of the transformer, and is an alternative to the G and Rc functions. This device works with an auxiliary supply.

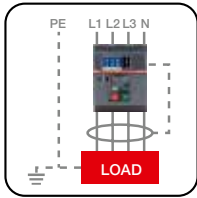

RC Residual current

This is available only for the XT7, with a constant time ($t=k$) and protects against indirect contacts and is integrated into the Ekip Touch LSIG with an Ekip Measuring with a dedicated residual current rating plug and external toroid. The protection is an alternative to the G and Gext functions.

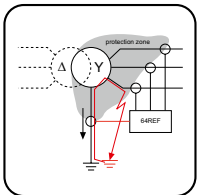

Second protection against ground fault

This is available only for the XT7. Whereas with the Ekip Touch, the user has to choose between implementation of the G type protection using internal current sensors (calculating the vector sum of the currents) or Gext external toroids (direct measurement of the ground fault current), the Ekip Hi-Touch offers the exclusive feature of simultaneous management of both configurations by two independent ground fault protection curves. Owing to this characteristic, the trip unit is able to distinguish a non-restricted from a restricted ground fault, and then activate the opening of the circuit-breaker and command the opening of the medium voltage circuit-breaker. Another possible configuration is with the residual current protection replacing the Gext protection, while the G protection remains active. The residual current protection is activated in the presence of the residual current rating-plug and of the toroid.

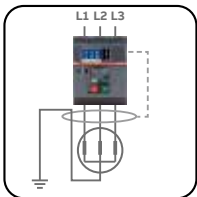

RC Differential ground fault protection against ground faults

Available on the XT7 only, this unit protects against internal ground faults on the generator windings. It is required that the toroid (additional accessory) embraces the active conductors and the ground conductor. RC protection is integrated via a dedicated residual current rating plug and an external toroid.

Ekip Touch/Hi-Touch

Additional protection functions

Additional protection functions:

Protection	Thermal memory	Trip Enable	Zone Selectivity	StartUp enable	Blocks	Directional Zone Selectivity
L	●					
S	●	●	●	●	●	
I				●	●	
G		●	●	●	●	
MCR					●	
IU		●				
T		●				
S2		●	●	●	●	
D				●		●
UV				●		
OV				●		
VU				●		
UF				●		
OF				●		
RP				●		
S(V)				●		
S2(V)				●		
RV				●		
RQ				●		
RQ2				●		
OQ				●		
OP				●		
UP				●		
ROCOF				●		
UV2		●			●	
OV2		●			●	
UF2		●			●	
OF2		●			●	
UP		●				
Gext		●	●			

Thermal memory

This function is used to protect components such as transformers and cables against overheating due to overloads. It adjusts the trip time of the protection according to the time elapsed after the first overload, taking account of the overheating caused. It can be activated when a $t = k/I^2$ (with an inverse long time) curve is used.

Trip Enable

The function enables the trip to be excluded so that only the alarm is indicated. This is used in installations where continuity of service is an essential requirement.

Zone Selectivity

The function allows multiple circuit-breakers belonging to the same installation to be connected together, in order to coordinate the trip units and to reduce the tripping times in the case of protections S, G and S2. Thus, in the event of a failure:

- the circuit-breaker closest to the fault trips
- the other circuit-breakers are locked for a programmable time.

Each circuit-breaker that detects a fault reports it to the circuit-breaker upstream; the circuit-breaker that detects the fault but does not receive any communication from those downstream opens without waiting for the set delay to elapse.

It is possible to enable zone selectivity if a fixed-time curve has been selected and the auxiliary supply is present.

StartUp Enable

The function modifies the threshold of the protection for a period that can be set by the user, avoiding unwanted trips due to high inrush currents of certain loads (motors, transformers, lamps). The starting phase lasts 100ms to 30s and is recognized automatically by the trip unit:

- at the closing of the circuit-breaker with a self-supplied trip unit;
- when the peak value of the maximum current exceeds the set threshold ($0.1...10 \times I_n$) with an externally supplied trip unit.

A new start-up is possible after the current falls below the threshold. This function can be activated with a fixed time protection function ($t = k$). Moreover, the I3 startup threshold must be higher than the I2 startup threshold.

Protection blocks

With the Ekip Connect software, six blocks are available for some protections, which is useful for deactivating the protection based on programmable events. In particular:

- four blocks are associated with the programmable states A, B, C and D
- one block is associated with the start-up (present for protections that have a StartUp function);
- one block, not present for frequency protections, is associated with the checking of the measured frequency.

Each block is independent and has its own activation command. The protection is deactivated for a time equal to the duration of the event itself:

- if the programmed event occurs (true), in the case of state-based blocks
- if the StartUp function is active and the start-up threshold is exceeded (the active block for the set start-up time), whenever the StartUp block function is enabled.
- if at least one frequency measured is outside the range 30...80 Hz, in the case of a frequency based block.

Directional Zone Selectivity

The Zone Selectivity function allows multiple circuit-breakers belonging to the same installation to be connected together in order to coordinate the trip units and reduce tripping times, but with some important differences:

- it is to be used in installations with a ring circuit
- it allows tripping to be managed and coordinated according to the power flows (determined by the direction of the current), in order to minimize dispersion of energy.

It works as an alternative to S and G Zone Selectivity.

Ekip Touch/Hi-Touch

Protection settings

Available settings for each protection function:

ABB Code	ANSI Code	Function	Threshold Range	Threshold Step
Protections				
L	49	Overload according to 60947-2	$I1 = 0.4...1 \times I_n$	$0.001 \times I_n$
	49	Overload according to 60255-151	$I1 = 0.4...1 \times I_n$	$0.001 \times I_n$
S	50 TD	Time-delayed overcurrent	$I2 = 0.6...10 \times I_n$	$0.1 \times I_n$
	68	Zone selectivity		
		Start up	Activation: $0.6...10 \times I_n$	$0.1 \times I_n$
51	Time-delayed overcurrent	$I2 = 0.6...10 \times I_n$	$0.1 \times I_n$	
I	50	Instantaneous short-circuit	XT2-XT4-XT5: $I3 = 1.5...10 \times I_n$ XT7: $I3 = 1.5...15 \times I_n$	$0.1 \times I_n$
		Start up	Activation: XT2-XT4-XT5: $I3 = 1.5...10 \times I_n$ XT7: $I3 = 1.5...15 \times I_n$	$0.1 \times I_n$
G (1)	50N/50N TD	Earth fault	$I4 = 0.1...1 \times I_n$	$0.001 \times I_n$
	68	Zone selectivity		
		Start up	Activation: $0.2...10 \times I_n$	$0.02 \times I_n$
	51N	Earth fault	$I4 = 0.1...1 \times I_n$	$0.001 \times I_n$
N		Neutral	On/Off	50%-100%-200% of the phases
2I	50	Programmable 2nd Instantaneous short-circuit	XT2-XT4-XT5: $I3 = 1.5...10 \times I_n$ XT7: $I3 = 1.5...15 \times I_n$	$0.1 \times I_n$
MCR		Closing on short-circuit	XT2-XT4-XT5: $I3 = 1.5...10 \times I_n$ XT7: $I3 = 1.5...15 \times I_n$	$0.1 \times I_n$
IU	46	Current unbalance	$I6 = 2...90\% I_n$ unbalance	$1\% I_n$
LC1/2 Iw1/2	-	Current threshold Activation up/down	$LC1 = 50...100\% \times I1$	1%
			$LC2 = 50...100\% \times I1$	1%
			$Iw1 = 0.1...10 \times I_n$ $Iw1 = 0.1...10 \times I_n$	$0.01 \times I_n$
S2	50 TD	2nd Time-delayed overcurrent	$I2 = 0.6...10 \times I_n$	$0.1 \times I_n$
	68	Zone selectivity		
Start up		Activation: $0.6...10 \times I_n$	$0.1 \times I_n$	
Phase Sequence	47	Cyclical direction of the phases	1-2-3 or 3-2-1	
UV	27	Undervoltage	$U8 = 0.5...0.98 \times U_n$	$0.001 \times U_n$
OV	59	Overvoltage	$U9 = 1.02...1.5 \times U_n$	$0.001 \times U_n$
UV2	27	2nd Undervoltage	$U15 = 0.5...0.98 \times U_n$	$0.001 \times U_n$
OV2	59	2nd Overvoltage	$U16 = 1.02...1.5 \times U_n$	$0.001 \times U_n$

Trip Time	Time Step	Excludability	Excludability trip	Pre-Alarm	Curve
XT2-XT4 : t1 = 3...60 s @ 3 x I1 XT5: t1 = 3...48 s @ 3 x I1 XT7: t1 = 3...144 s @ 3 x I1	1 s	no	no	50%...90% I1 step 1%	$t = k/I^2$
t1 = 3...144 s for XT7 t1 = 3...9 s for XT2-XT4-XT5 SI: k=0.14; α=0.02 VI: k=13.5; α=1 EI: k=80; α=2 SI: k=0.14; α=0.02 t = k / I4; k=80; α=4	1 s	no	no	50%...90% I1 step 1%	$t = (k t1)/((if/I1)α-1)$
XT2 - XT4 : t2 = 0.05...0.4 s XT5: t2 = 0.05...0.5 s XT7: t2 = 0.05...0.8 s	0.01 s	yes	yes	no	$t = k$
t2sel = 0.04...0.2 s @ 10 x In	0.01 s	yes			
Range: 0.1 ... 30s	0.01 s	yes			
XT2 - XT4 : t2 = 0.05...0.4 s @ 10 x In XT5: t2 = 0.05...0.5 s @ 10 x In XT7: t2 = 0.05...0.8 s @ 10 x In	0.01 s	yes	yes	no	$t = k/I^2$
Instantaneous		yes	no	no	$t = k$
Range: 0.1 ... 30s	0.01 s	yes			
t4 = Inst.0.1 ...1 s with I > I4	0.05 s	yes	yes	50%...90% I4 step 1%	$t = k$
t4sel = 0.04...0.2 s	0.01 s	yes			
Range: 0.1 ... 30s	0.01 s	yes			
t4 = 0.1...1 s	0.05 s	yes	yes	50%...90% I4 step 1%	$t = k/I^2$
		yes			
Instantaneous		yes	no	no	$t = k$
Instantaneous Monitor time range 40...500 ms	0.01 s	yes	no	no	$t = k$
t6 = 0.5...60 s	0.5 s	yes	yes	no	$t = k$
		yes	only signaling	no	
XT2 - XT4 : t2 = 0.05...0.4 s XT5: t2 = 0.05...0.5 s XT7: t2 = 0.05...0.8 s	0.01 s	yes	yes	no	$t = k$
t5sel = 0.04...0.2s	0.01 s	yes	yes		
Range: 0.1 ... 30s	0.01 s	yes			
		yes	only signaling	no	
t8 = 0.05...120 s	0.01 s	yes	yes	no	$t = k$
t9 = 0.05...120 s	0.01 s	yes	yes	no	$t = k$
t15 = 0.05...120 s	0.01 s	yes	yes	no	$t = k$
t16 = 0.05...120 s	0.01 s	yes	yes	no	$t = k$

Ekip Touch/Hi-Touch

Protection settings

ABB Code	ANSI Code	Function	Threshold Range	Threshold Step
Protections				
VU	47	Voltage unbalance	$U_{14} = 2...90 \% U_n$ unbalance	1% U_n
S(V)	51V	Voltage controlled overcurrent	$I_{20} = 0.6...10 \times I_n$	0.1 $\times I_n$
		Step mode (controlled mode)	$U_{I1} = 0.2...1 \times U_n$ $K_{s1} = 0.1...1$	0.01 $\times U_n$ 0.01
		Linear mode (restrained mode)	$U_{I1} = 0.2...1 \times U_n$ $U_{h1} = 0.2...1 \times U_n$ $K_{s1} = 0.1...1$	0.01 $\times U_n$ 0.01 $\times U_n$ 0.01
S2(V)	51V	2nd Voltage controlled overcurrent	$I_{21} = 0.6...10 \times I_n$	0.1 $\times I_n$
		Step mode (controlled mode)	$U_{I2} = 0.2...1 \times U_n$ $K_{s2} = 0.1...1$	0.01 $\times U_n$ 0.01
		Linear mode (restrained mode)	$U_{I2} = 0.2...1 \times U_n$ $U_{h2} = 0.2...1 \times U_n$ $K_{s2} = 0.1...1$	0.01 $\times U_n$ 0.01 $\times U_n$ 0.01
RV	59N	Residual overvoltage	$U_{22} = 0.05...0.5 \times U_n$	0.001 $\times U_n$
UF	81L	Underfrequency	$f_{12} = 0.9...0.999 f_n$	0.001 $\times f_n$
OF	81H	Overfrequency	$f_{13} = 1.001...1.1 f_n$	0.001 $\times f_n$
UF2	81L	2nd Underfrequency	$f_{17} = 0.9...0.999 f_n$	0.001 $\times f_n$
OF2	81H	2nd Overfrequency	$f_{18} = 1.001...1.1 f_n$	0.001 $\times f_n$
RP	32R	Reverse active power	$P_{11} = -1...-0.05 S_n$	0.001 S_n
Cos ϕ	78	Power factor	$\text{Cos } \phi = 0.5...0.95$	0.01
	D	67	Directional overcurrent	$I_{7 Fw/Bw} = 0.6...10 \times I_n$
	68	Zone selectivity		
		Start up	Activation: $0.6...10 \times I_n$	0.1 $\times I_n$
		Minimum angle of direction (°)	3.6, 7.2, 10.8, 14.5, 18.2, 22, 25.9, 30, 34.2, 38.7, 43.4, 48.6, 54.3, 61, 69.6	
RQ	40/32R	Loss of field or reverse reactive power	$Q_{24} = -1...-0.1 \times S_n$ $K_{q1} = -2...2$	0.001 $\times S_n$ 0.01
		Loss of field or reverse reactive power	$Q_{25} = -1...-0.1 \times S_n$ $K_{q2} = -2...2$	0.001 $\times S_n$ 0.01
		Minimum voltage threshold	$V_{min.} = 0.5...1.2$	0.01
OQ	320F	Reactive overpower	$Q_{27} = 0.4...2 \times S_n$	0.001 $\times S_n$
OP	320F	Active overpower	$P_{26} = 0.4...2 \times S_n$	0.001 $\times S_n$
UP	32LF	Active underpower	$P_{23} = 0.1...1 \times S_n$	0.001 $\times S_n$
		StartUp		
ROCOF	81R	Rate of change of frequency	$f_{28} = 0.4...10 \text{ Hz / s (up \&/or down)}$	0.2 Hz/s
L (Motor Protection)		Motor protection overload	$I_1 = 0.4...1 \times I_n$	0.001 $\times I_n$
		According 60947-4-1		
R	51R	Rotor blockage - Jam	$I_j = 2...10 \times I_1$	0.1
	51R	Rotor blockage - Stall	$I_s = 1...10 \times I_1$	0.1
U		Phase lackand/or unbalance	On/Off	-
Un	46	Phase unbalance	$20...50\% \times I_1$	10%
Uc	37	Undercurrent	$50...90\% \times I_1$	10%

Trip Time	Time Step	Excludability	Excludability trip	Pre-Allarm	Curve
t14 = 0.5...60 s	0.5 s	yes	yes	no	t = k
t20 = 0.05...30 s	0.01 s	yes	yes	no	t = k
t21 = 0.05...30 s	0.01 s	yes	yes	no	t = k
t22 = 0.5...120 s	0.01 s	yes	yes	no	t = k
t12 = 0.15...300 s	0.01 s	yes	yes	no	t = k
t13 = 0.15...300 s	0.01 s	yes	yes	no	t = k
t17 = 0.15...300 s	0.01 s	yes	yes	no	t = k
t18 = 0.15...300 s	0.01 s	yes	yes	no	t = k
t11 = 0.5...100 s	0.1 s	yes	yes	no	t = k
t7 Fw/Bw = 0.2...0.8 s	0.01 s	yes	only signaling	no	t = k
t7sel = 0.13...0.5s	0.01 s	yes			
Range 0.1...0.8s	0.01 s	yes			
t24 = 0.5...100 s	0.1 s	yes	yes	no	t = k
t24 = 0.5...100 s	0.1 s	yes	yes	no	t = k
t27 = 0.5...100 s	0.5 s	yes	yes	no	t = k
t26 = 0.5...100 s	0.5 s	yes	yes	no	t = k
t23 = 0.5...100 s	0.5 s	yes	yes	no	t = k
Range from closing: 0.1...30S or with digital input	0.01 s	yes			-
t28 = 0.5...10 s for f>f28	0.01 s	yes	yes	no	t = k
XT2-XT4: 5E - 10E - 20E					t = k/l ²
XT5-XT7: 5E - 10E - 20E - 30E					
tj = 1...10 s	0.5 s				t = k
ts = 2...10 s	0.5 s				t = k
tu = 1...10 s	0.5 s				t = k
tun = 1...10 s	0.5 s				t = k
tuc = 1...20 s	0.5 s				t = k

Ekip Touch/Hi-Touch

Protection settings

ABB Code	ANSI Code	Function	Threshold Range	Threshold Step
Protection with additional modules				
SC Synchrocheck	25	Synchrocheck (Live busbars)	U _{live} = 0.5...1.1 x U _n ΔU = 0.02...0.12 x U _n Δf = 0.1...1 x Hz ΔΦ 5...50° elt	0.001 x U _n 0.001 x U _n 0.1 x Hz 5° elt
		Synchrocheck (Live/Dead busbars)	U _{live} = 0.5...1.1 x U _n U _{dead} = 0.02...0.2 x U _n	0.001 x U _n 0.001 x U _n
		Frequency check off		
		Phase check off		
		Dead bar configuration	Reverse/Standard	
		Primary voltage	100...1150	100, 115, 120, 190, 208, 220, 230, 240, 277, 347, 380, 400, 415, 440, 480, 500, 550, 600, 660, 690, 910, 950, 1000, 1150
		Secondary voltage	100...120	100, 110, 115, 120
Gext⁽¹⁾	50G TD	Earth fault	I ₄ = 0.1...1 x I _n toroid	0.001 x I _n Toroid
	68	Zone selectivity		
		Start up	Activation: 0.1...1 x I _n	0.02 x I _n
51G	Earth fault	I _{4⁽¹⁾} = 0.1...1 x I _n	0.001 x I _n	
Rc	64 50N TD 87N	Residual current / Differential ground fault	IΔn = 3 - 5 - 7 - 10 - 20 - 30A	

The RC for the XT7 is active only when the rating plug is present. All of the Synchrocheck functions are for signaling.

An adjustable pre-alarm threshold (50...90% I₁) is available for L protection, as well as a fixed pre-alarm threshold is available for G and Gext protection.

Trip Time	Time Step	Excludability	Excludability trip	Pre-Allarm	Curve
Stability voltage time for live state = 100...30000ms Minimum matching time = 100...3000ms tref = 0.1...30 s	0.001 s 0.01 s 0.1 s	yes yes yes yes	only signaling only signaling	no no	
t41 = 0.1...1 s	0.05 s	yes	yes	50...90% I41 step 1%	t = k
t41sel = 0.04...0.2 s	0.01 s	yes			
Range: 0.1...30s	0.01 s	yes			
t41 = 0.1...1 s with I = 4 x In	0.05 s	yes	yes	50...90% I41 step 1%	t = k/I ²
tΔn = 0.06 – 0.1 – 0.2 – 0.3 – 0.4 – 0.5 – 0.8 s			no	no	t = k

Ekip Touch/Hi-Touch

Tolerances

ABB Code	ANSI Code	Function	Threshold Range	Trip Time
Protections				
L	49	Overload according to 60947-2	trip between 1.05 and 1.2 x I1	± 10% I ≤ 6 x In ± 20% I ≥ 6 x In
	49	Overload according to 60255-151	trip between 1.05 and 1.2 x I1	± 10% I ≤ 6 x In ± 20% I ≥ 6 x In
S	50 TD	Selective short-circuit	± 7% I ≤ 6 x In ± 10% I ≥ 6 x In	The better of the two data: ± 10% or ± 40ms
	51	Selective short-circuit	± 7% I ≤ 6 x In ± 10% I ≥ 6 x In	± 15% I ≤ 6 x In ± 20% I ≥ 6 x In
I	50	Instantaneous short-circuit	± 10%	≤ 30ms
G ⁽¹⁾	68	Earth Fault	± 7%	The better of the two data: ± 10% or ± 40ms with t4=instantaneous
	51N	Earth Fault	± 7%	± 15%
2I	50	2nd Instantaneous short-circuit	± 10%	≤ 30ms
MCR		Closing on short-circuit	± 10%	≤ 30ms
IU	46	Current unbalance	10%	The better of the two data: ± 10% or ± 40ms (for t5<5s) / ± 40ms (for t5 ≥ 5s)
LC1/2 - Iw1/2		Current threshold	± 10%	
S2	68	2nd Selective short-circuit	± 7% I ≤ 6 x In ± 10% I ≥ 6 x In	The better of the two data: ± 10% or ± 40ms
UV	27	Undervoltage	± 2%	The better of the two data: ± 10% or ± 40ms (for t5<5s) / ± 40ms (for t5 ≥ 5s)
OV	59	Overvoltage	± 2%	The better of the two data: ± 10% or ± 40ms (for t5<5s) / ± 40ms (for t5 ≥ 5s)
UV2	27	2nd Undervoltage	± 2%	The better of the two data: ± 10% or ± 40ms (for t5<5s) / ± 40ms (for t5 ≥ 5s)
OV2	59	2nd Overvoltage	± 2%	The better of the two data: ± 10% or ± 40ms (for t5<5s) / ± 40ms (for t5 ≥ 5s)
VU	47	Voltage unbalance	± 5%	The better of the two data: ± 10% or ± 40ms (for t5<5s) / ± 40ms (for t5 ≥ 5s)
S(V)	51V	Voltage controlled overcurrent	± 10%	The better of the two data: ± 10% or ± 40ms (for t5<5s) / ± 40ms (for t5 ≥ 5s)
S2(V)	51V	2nd Voltage controlled overcurrent	± 10%	The better of the two data: ± 10% or ± 40ms (for t5<5s) / ± 40ms (for t5 ≥ 5s)
RV	59N	Residual overvoltage	± 5%	The better of the two data: ± 10% or ± 40ms (for t5<5s) / ± 40ms (for t5 ≥ 5s)
UF	81L	Underfrequency	± 1% (with fn ± 2%)	The better of the two data: ± 10% or ± 40ms (for t5<5s) / ± 40ms (for t5 ≥ 5s)
OF	81H	Overfrequency	± 1% (with fn ± 2%)	The better of the two data: ± 10% or ± 40ms (for t5<5s) / ± 40ms (for t5 ≥ 5s)
UF2	81L	2nd Underfrequency	± 1% (with fn ± 2%)	The better of the two data: ± 10% or ± 40ms (for t5<5s) / ± 40ms (for t5 ≥ 5s)
OF2	81H	2nd Overfrequency	± 1% (with fn ± 2%)	The better of the two data: ± 10% or ± 40ms (for t5<5s) / ± 40ms (for t5 ≥ 5s)

ABB Code	ANSI Code	Function	Threshold Range	Trip Time
RP	32R	Reverse active power	± 10%	The better of the two data: ± 10% or ± 40ms (for t5<5s) / ± 40ms (for t5 ≥ 5s)
D	68	Directional overcurrent	± 7% I ≤ 6 x I _n ± 10% I ≥ 6 x I _n	If t7 ≤ 200 ms : +/-20 ms If 200ms < t7 ≤ 400 ms : 10% If con t7 > 400 ms : 40 ms
RQ	40/32R	Loss of field or reverse reactive power	± 10%	The better of the two data: ± 10% or ± 40ms (for t5<5s) / ± 40ms (for t5 ≥ 5s)
OQ	320F	Reactive overpower	± 10%	The better of the two data: ± 10% or ± 40ms (for t5<5s) / ± 40ms (for t5 ≥ 5s)
OP	320F	Active overpower	± 10%	The better of the two data: ± 10% or ± 40ms (for t5<5s) / ± 40ms (for t5 ≥ 5s)
UP	32LF	Active underpower	± 10%	The better of the two data: ± 10% or ± 40ms (for t5<5s) / ± 40ms (for t5 ≥ 5s)
ROCOF	81R	Rate of change of frequency	± 5%	The better of the two data: ± 10% or ± 40ms
L (Motor Protection)		Motor protection overload According 60947-4-1		
R	51LR	Rotor blockage - Jam	I _j = 2...10 x I ₁	t _j = 1...10 s
	51LR	Rotor blockage - Stall	I _s = 1...10 x I ₁	t _s = 2...10 s
U				
Un	46			
Uc	37			
Protection with additional modules				
SC Synchrocheck	25	Synchrocheck (Live busbars)	10%	
		Synchrocheck (Live. Dead busbars)	10%	
Gext ⁽¹⁾	68	Earth fault	± 7%	The better of the two data: ± 10% or ± 40ms
	51G	Earth fault	± 7%	± 15%
	51G	Earth fault		
Rc	64 50N TD 87N	Residual current / Differential ground fault	- 20% ÷ 0%	140ms @ 0.06s (max trip time) 950ms @ 0.80s (max trip time)

(1) With Vaux all thresholds are available. Without Vaux the minimum threshold is limited to: 0.3 x I_n for XT2 and XT4 with I_n ≤ 100A; 0.25 for XT5 with I_n ≤ 300A; 0.2 x I_n for all the other ratings.

The tolerances above apply to trip units already powered by the main circuit with current flowing in at least two phases or an auxiliary power supply. In all other cases the following tolerance values apply:

ABB Code	Trip threshold	Trip time
L	Trip between 1.05 and 1.2 x I ₁	± 20%
S	± 10%	± 20%
I	± 15%	≤ 60ms
G	± 15%	± 20%
Other protection	± 15%	± 20%

Ekip Touch/Hi-Touch

Measurement functions and data

Currents

All the Ekip Touch/Hi-Touch trip units measure the RMS value of the instantaneous currents of the three phases and the neutral. There are two different levels of accuracy depending on the version (0.5% and 1%). In addition, also the minimum and maximum values recorded within an adjustable time interval are available.

Voltage

Instantaneous phase-to-phase and phase-to-neutral voltages can be measured. They are available at a 0.5% level of accuracy. In addition, the minimum and maximum values recorded within an adjustable time interval are available.

Power

Real time measurements of the total and phase power. Available at 2 different level of accuracy depending on the version, 1 % and 2%. In addition, the minimum and maximum values recorded within an adjustable time interval are available.

Energy meters

Measurements of the active, reactive and apparent energy totals, updated every minute. The measurements can be reset when needed.

Frequency

Measurement of line real time frequency, expressed in hertz.

Peak Factor

Real time measurements of the peak factors of the phase currents. The measurements are expressed as a ratio between the peak values and RMS values, for each single phase.

Power Factor

Power factor and real time measurements of the ratio between the total active power and total apparent power, expressed as $\cos\phi$. In addition, the trip unit signals an alarm if the $\cos\phi$ value drops below an adjustable threshold, settable via Ekip Connect software (from 0.5 to 0.95).

Datalogger

This function allows the data related to a trigger event to be recorded. These data are:

- Analog measurements: phase currents and phase-to-phase voltages
- Digital events: protection alarms, circuit-breaker status signals, tripping of protections.

When the datalogger is activated, the trip unit continuously acquires data by filling and emptying an internal register. If a trigger event occurs, the trip unit inhibits acquisition (either immediately or with an adjustable time-lag) and stores the data, which is available for downloading.

Network Analyzer

This function fully evaluates the quality of the network. It is possible to set the controls to long cycle voltage and current in order to analyze the system functionality. Voltages and currents are monitored to find:

- The sequence of voltages
- Short term voltage drops or interruptions
- Short duration voltage increases
- Slow voltage drops
- Slow voltage increases
- Unbalances between the voltages
- Harmonic distortion of voltages and currents.

Waveforms

A selected quantity can be represented as a waveform and acquired at the moment of selection. The phase current and phase-to-phase voltage can be displayed.

Harmonics

A representation in the form of a histogram of the measurements of the harmonics that make up the waveform, and related to the frequency set.

Operation counter

In the presence of a power supply, the trip unit records information about the openings of the circuit-breaker including:

- the number of manual openings
- the total number of operations (manual + trips).

By activating communication with the trip unit, the following parameters are also available:

- the number of openings due to protection tripping
- the number of openings for which tripping has not been completed in due time (back-up commands have been necessary)
- the number of opening tests performed.

Contact wear

This gives an estimation of the conditions of the main circuit-breaker contacts. The value is expressed as a percentage, and is 0% in case of no wear, and 100% in case of total wear. This is calculated automatically by the trip unit at every opening for protection or, in the presence of a power supply, also at every manual opening of the circuit-breaker.

Openings

Information about the last 30 openings are available. In particular:

- tripped protection
- the progressive number of the opening
- the date and time of the opening (referred to the internal clock)
- measurements associated with the trip protection.

The most recent opening is viewable also by pressing the iTest key.

Events

The last 200 events are recorded. The following information is available:

- trip unit: configuration status of the bus, operating mode, active set, auxiliary power supply
- protections: delay in action or alarms
- connection states or alarms: circuit-breaker, current sensors, trip coil, rating plug
- tripping: state of the opening command, or signal of tripping for protection.

The icons help to quickly understand the type of event:



event reported for information purposes



delay of a protection in progress, trip expected



alarm referring to a non-hazardous condition



alarm for operation, failure, or connection fault.

Synchrocheck

Synchrocheck measurements relating to the function of synchronism between two independent power sources.

Ekip Touch/Hi-Touch

Measurement functions and data

The parameters measurable for each trip unit are shown in the following tables. Three different software packages are available to upgrade the trip units:

- Measuring package for measurement of voltage, power and energy
- Datalogger for data record
- Network Analyzer for the evaluation of the power quality.

Instantaneous measurements			Ekip Touch	Ekip Touch Measuring	Ekip Hi-Touch	Ekip M Touch	Ekip G Touch	Ekip G Hi-Touch
Currents (RMS)	L1, L2, L3, Ne	[A]	●	●	●	●	●	●
Ground fault current (RMS)	Ig	[A]	●	●	●	●	●	●
Measuring package				●	●	●	●	●
Phase-to-phase voltage (RMS)	U12, U23, U31	[V]	○	●	●	●	●	●
Phase-to-neutral voltage (RMS)	U1, U2, U3	[V]	○	●	●	●	●	●
Phase sequence			○	●	●	●	●	●
Frequency	f	[Hz]	○	●	●	●	●	●
Active power	P1, P2, P3, Ptot	[kW]	○	●	●	●	●	●
Reactive power	Q1, Q2, Q3, Qtot	[kVAR]	○	●	●	●	●	●
Apparent power	S1, S2, S3, Stot	[KVA]	○	●	●	●	●	●
Power factor	PF1, PF2, PF3, PF total		○	●	●	●	●	●
Peak factor	total		○	●	●	●	●	●
Counters: recorded from installation or from the last reset								
Active energy	Ep total, Ep positive, Ep negative	[kW]	○	●	●	●	●	●
Reactive energy	Eq total, Ep positive, Ep negative	[kVAR]	○	●	●	●	●	●
Apparent energy	Es total	[KVA]	○	●	●	●	●	●

● Available as standard

○ Available as software package to be ordered via ABB Ability Marketplace™ or during the circuit-breaker ordering phase

Depending on the need, two different accuracy levels are available for the trip unit, the Standard Precision and High Precision certified according to IEC 61557-12:

Instantaneous measurements		Standard Precision	High Precision certified according to IEC 61557-12
Currents (RMS)	[A] L1, L2, L3, Ne	1%	0.50%
Ground fault current (RMS)	[A] I _g	2%	0.50%
Phase-to-phase voltage (RMS)	[V] U12, U23, U31	0.50%	0.50%
Phase-to-neutral voltage (RMS)	[V] U1, U2, U3	0.50%	0.50%
Frequency	[Hz] f	0.20%	0.20%
Active power	[kW] P1, P2, P3, P _{tot}	2%	1%
Reactive power	[kVAR] Q1, Q2, Q3, Q _{tot}	2%	2%
Apparent power	[KVA] S1, S2, S3, S _{tot}	2%	1%
Power factor	PF1, PF2, PF3, PF total	2%	1%
Active energy	[kW] E _p total, E _p positive, E _p negative	2%	1%
Reactive energy	[kVAR] E _q total, E _p positive, E _p negative	2%	2%
Apparent energy	[KVA] E _s total	2%	1%

The lowest current value that the trip units Ekip Touch/Hi-Touch can measure is 0.004 x I_n

High Precision certified according to IEC 61557-12

Available only for factory assembled circuit-breakers, this accuracy is available as default on the Ekip Hi-Touch and Ekip G Hi-Touch trip units; anyway, it is always possible to have this accuracy for the other Ekip Touch trip units by adding the dedicated commercial codes upon ordering.

For XT2 Ekip Touch trip units the High Precision is available in general for I_n ≥ 100A.

Ekip Touch/Hi-Touch

Measurement functions and data

Network Analyzer		Interval
Hourly average voltage value	[V] [no] - Umin= 0.75...0.95 x Un - Umax= 1.05...1.25 x Un - Events counter ⁽¹⁾	t = 5...120min
Short voltage interruptions	[no] - Umin= 0.75...0.95 x Un - Events counter ⁽¹⁾	t <40ms
Short voltage spikes	[no] - Umax= 1.05...1.25 x Un - Events counter ⁽¹⁾	t <40ms
Slow voltage sags and swells	[no] - Umin1= 0.75...0.95 x Un - Umin2= 0.75...0.95 x Un - Umin3= 0.75...0.95 x Un - Umax1= 1.05...1.25 x Un - Umax2= 1.05...1.25 x Un - Events counter ⁽¹⁾	t = 0.02s...60s
Voltage unbalance	[V] [no] - U neg. seq.= 0.02...0.10 x Un - Events counter ⁽¹⁾	t = 5...120min
Harmonic analysis	Current and Voltage - up to 50° - Alarm THD: 5...20% - Single harmonic alarm: 3...10% plus a count of minutes the harmonic has been exceeded	

● Available as standard

○ Available as software package to be ordered via ABB Ability Marketplace™ or during the circuit-breaker ordering phase. To add this function, the Measuring package must be installed first.

Ekip Touch	Ekip Touch Measuring	Ekip Hi-Touch	Ekip M Touch	Ekip G Touch	Ekip G Hi-Touch
○ ²	○ ²	●	○	○	●
○ ²	○ ²	●	○	○	●
○ ²	○ ²	●	○	○	●
○ ²	○ ²	●	○	○	●
○ ²	○ ²	●	○	○	●
○ ²	○ ²	●	○	○	●

1) No. of events day by day in the last year plus the total events in the breaker's lifetime
 2) Not available for Ekip Touch and Ekip Touch Measuring for XT2 and XT4

Ekip Touch/Hi-Touch

Measurement functions and data

Record of values: for each interval with time-stamping	Parameters	Window & interval
Current: minimum and maximum	[A] I Min, I Max	Fixed synchronizable by remote
Phase-to-phase voltage: minimum and maximum	[V] U Min, U max	Duration: 5...120min
Active power: average and maximum	[kW] P Mean, P Max	Number of intervals: 24
Reactive power: average and maximum	[kVAR] Q Mean, Q Max	
Apparent power: average and maximum	[KVA] S Mean, S Max	
Data logger: high rate sampling record of parameters	Parameters	
Currents	[A] L1, L2, L3, Ne, Ig	Fixed synchronizable by remote
Voltages	[V] U12, U23, U31	
Sampling rate	[Hz] 1200-9600	Duration: 5...120min
Maximum recording duration	[s] 18	Number of intervals: 24
Recording stop delay	[s] 0-10s	
Number of registers	[no] 2 independent	
Info on trip & opening data: after a fault without auxiliary supply	Parameters	
Type of protection tripped	eg. L, S, I, G, UV, OV	
Fault values per phase	[A/V/Hz w/VAR] eg. I1, I2, I3, neutral for S protection V12, V23, V32 for UV protection	
Time-stamping	Date, time and progressive number	
Maintenance indicators	Parameters	
Information on last 30 trips	Type of protection, fault values and time-stamping	
Information on last 200 events	Type of event, time-stamping	
Number of mechanical operations	can be associated to alarm	
Total number of trips	[no]	
Total operating time	[no]	
Wear of contacts	[h] Pre-alarm >80% Alarm = 100%	
Date of maintenance operations performed	[%] Last	
Indication of maintenance operation needed		
Circuit-breaker I.D.	Type of circuit-breaker, assigned device name, serial number	
Self-diagnosis	Parameters	
Check of continuity of internal connections	Alarm due to disconnection: rating plug, sensors, trip coil	Note: Opening of the circuit-breaker
Failure of circuit-breaker to open (ANSI 50BF)	Alarm following non-tripping of protection functions	can be set in the event of alarm
Temperature (OT)	Pre-alarm and alarm for abnormal temperature	

● Available as standard

○ Available as software package to be ordered via ABB Ability Marketplace™ or during the circuit-breaker ordering phase. To add this function, the Measuring package must be installed first.

●	●	●	●	●	●
○	●	●	●	●	●
○	●	●	●	●	●
○	●	●	●	●	●
○	●	●	●	●	●
○ ²	○ ²	●	○	●	●
○ ²	○ ²	●	○	●	●
○ ²	○ ²	●	○	●	●
○ ²	○ ²	●	○	●	●
○ ²	○ ²	●	○	●	●
○ ²	○ ²	●	○	●	●
●	●	●	●	●	●
●	●	●	●	●	●
●	●	●	●	●	●
●	●	●	●	●	●
●	●	●	●	●	●
●	●	●	●	●	●
●	●	●	●	●	●
●	●	●	●	●	●
●	●	●	●	●	●
●	●	●	●	●	●
●	●	●	●	●	●
●	●	●	●	●	●

1) No. of events day by day in the last year plus the total events in the breaker's lifetime
2) Not available for Ekip Touch and Ekip Touch Measuring for XT2 and XT4

Communication and connectivity

- 4/2** **Introduction**
- 4/4** **Switchgear compartment**
 - Electrical switchgear**
 - 4/6** Remote communication
 - 4/8** Ekip Control Panel & Ekip Link
 - Electrical system**
 - 4/10** Software applications
 - 4/12** Ekip Connect
 - 4/14** Ekip view
- 4/16** **Software and web application**
- 4/18** **Accessories for Ekip Touch trip units**
- 4/27** **Accessories for electronic trip units**
- 4/28** **Accessories for XT2-XT4 Ekip trip units**

Introduction

The Tmax XT circuit-breakers are fully ready for Industry 4.0 requirements. The increasing number of connected objects and people is transforming electrical installation systems, bringing forward new potential in efficiency and productivity.

The Ekip Touch trip unit series can be connected in several ways to different networks and systems. According to their complexity, the supervision of low-voltage systems may involve different levels. Depending on where the supervision is needed, different communication configurations are available.

Switchgear compartment: control of the main electrical values of the circuit-breaker and set the protection functions, thanks to:

- embedded display of the trip units
- Ekip Multimeter display connected to the trip unit
- smartphone connection via embedded Bluetooth.

Electrical switchgear: display of the data of all circuit-breakers installed in the switchgear from a single point:

- locally via Ekip Control Panel on the front of the switchgear, collecting data from all the circuit-breakers and other devices in the switchboard
- remotely via several communication protocols.

Electrical system: management of complex systems in which the devices must be integrated in automated industrial processes or in intelligent electrical networks, better known as smart grids.

The system can be supervised by:

- Ekip View software
- Internet with the ABB Ability™ Electrical Distribution Control System webapp.





For all the possible supervision modes, connectivity modules are necessary. Two mounting solutions are possible, one excluding the other:

- **Internally**, it is possible to mount the Ekip Com modules in the circuit-breaker. This solution can be used on XT2, XT4 and XT5 circuit-breakers. The module is mounted directly inside the circuit-breaker with no additional space needed in the switchboard. For this configuration, dedicated internal module codes are available.
- **Externally**, through the Ekip Cartridge. The modules can be installed inside the cartridge, which is directly connected to the trip unit by a cable. Available with the XT2, XT4 and XT5 sizes. The Ekip cartridge is available in two versions depending on how many modules are needed.

The solution with the external cartridge permits a double or even triple communication channel, as well as redundant communication. Besides, the cartridge solution makes it possible the use of advanced functions, such as Synchro Reclosing, embedded ATS and more.

When an internal module is used, the Ekip Cartridge cannot be used and vice versa.

It has to be highlighted that, for the XT7 and XT7 M sizes, the modules must be installed directly on the terminal box available on the upper part of the circuit-breaker. The modules are the same of the Ekip Cartridge. On the upper part of the circuit-breaker it is possible to install one Ekip Supply plus maximum two additional modules.

Switchgear compartment

Display solutions

—
For the list of information available for each trip unit, see Chapter 3.

—
SACE Tmax XT circuit-breakers equipped with Ekip Touch/Hi-Touch electronic trip units enable electrical measurements and diagnostic data to be displayed on the front of the switchgear.

Solution with Ekip Touch trip units display

The Ekip Touch electronic trip units are the ideal solution for supervision and control of the compartments inside a switchgear. In detail:

- their use is simple and intuitive thanks to an embedded front display with push buttons on XT2 and XT4 sizes and a high resolution color touch screen display on XT5, XT7 and XT7 M sizes
- they do not require an auxiliary power supply for safety; the Ekip Touch trip units are directly supplied by the current sensors integrated in the circuit-breaker, thereby avoiding the use of external power supplies.

—
The Ekip Multimeter is a display unit to be installed on the front of the switchgear for SACE Tmax XT molded case circuit-breakers equipped with Ekip Touch electronic trip units.

Solution with Ekip Multimeter Display on the front of the switchgear

This device displays information about the system available in the trip unit to which it is connected and enables the adjustment of the parameters and protection thresholds.

The main characteristics of the Ekip Multimeter unit are:

- **Graphical and functional uniformity with the Ekip Touch trip units:** the Ekip Multimeter uses the same display as the trip unit to which it is connected, ensuring perfect continuity between the graphic display and the menu items.
- **Reduced dimensions:** the Ekip Multimeter guarantees the precision of the trip unit to which it is connected and performs the function of a measuring instrument without requiring the installation of external current and voltage transformers.
- **Flexible installation:** the Ekip Multimeter can be installed at a distance from the trip unit, enabling access to information from the most convenient point.
- **Simultaneous reading of the various electrical values:** the advanced connection system used allows several Ekip Multimeter devices to be connected to the same protection trip unit.

—
Embedded Bluetooth for a quick and wireless connection to your smartphone.

Solution with a smartphone connected via Bluetooth to the trip unit thanks to EPiC

Via the Ekip Connect App, it is possible to:

- check and modify the protection functions settings
- read the measurements available on the trip unit
- buy the functions to upgrade the trip unit from the ABB Ability Marketplace™ and enable them directly on the trip unit
- download and share test reports of the trip unit.

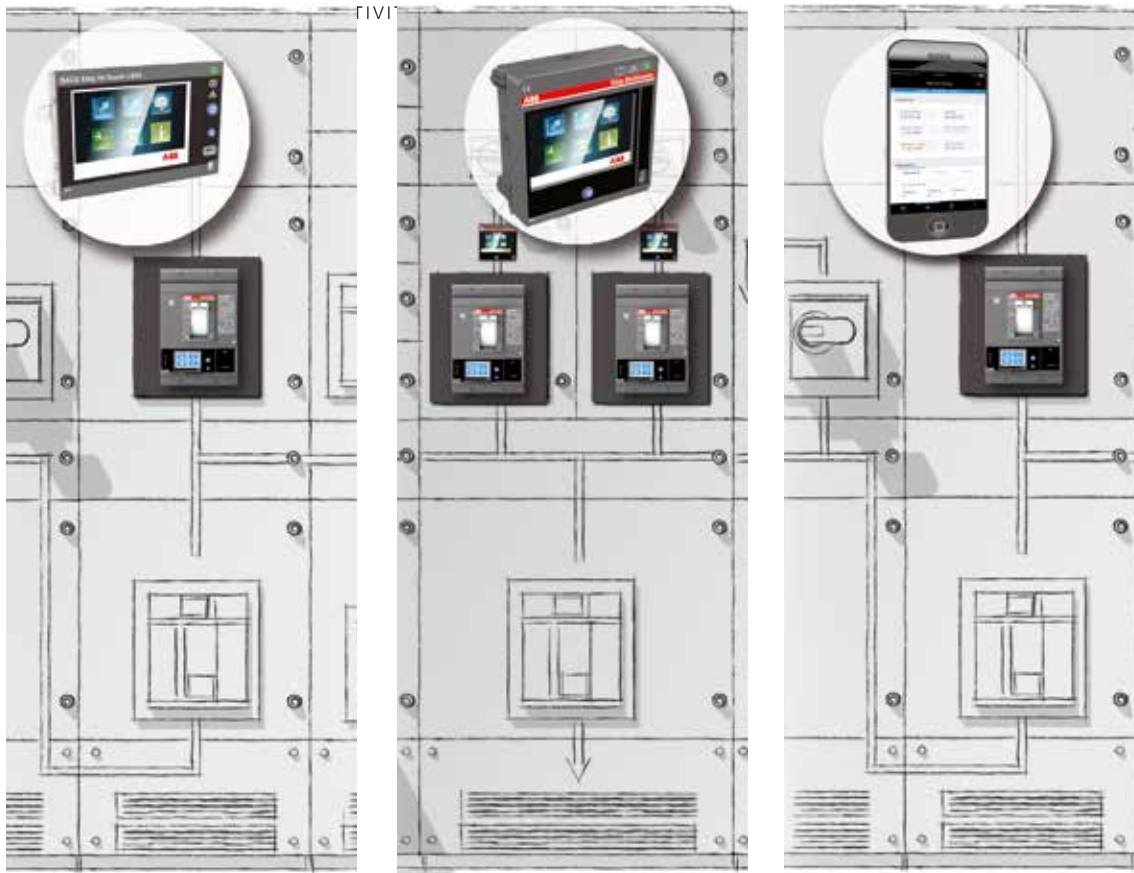

- 01 Ekip Touch
- 02 Ekip Multimeter
- 03 EPiC

Ekip Touch trip unit	Integrated display	Ekip Multimeter	Smartphone with EPiC
Measurement functions			
Currents	●	●	●
Voltages	○	○	○
Powers	○	○	○
Energies	○	○	○
Harmonics	○	○	○
Network analyzer	○	○	○
Adjustment functions			
Setting of thresholds	●	●	●
Setting second set thresholds	○	○	○
Resetting of alarms	●	●	●
Upgrade of the trip unit functions			
Purchase of functions			●
Installation of function			●
Diagnostics			
Protection function alarms	●	●	●
Device alarms	●	●	●
Protection unit tripping details	●	●	●
Events log	●	●	●
Protection unit tripping log	●	●	●
Maintenance			
Number of operations	●	●	●
Number of trips	●	●	●
Contact wear	●	●	●
Other data			
Status of circuit-breaker	●	●	●
Local/remote mode	●	●	●

● Default available
 ○ Available depending on the trip unit

Electrical switchgear

Remote communication

The integration of low-voltage devices in communication networks is required, in particular for: automated industrial processes, industrial and petrochemical sites, modern data centers and intelligent electricity networks, better known as smart grids.

Ekip Com Modules

Thanks to the wide range of communication protocols supported, SACE Tmax XT circuit-breakers equipped with Ekip Touch/Hi-Touch electronic trip units can be integrated into communication networks without the need for external interface devices. The distinctive characteristics of the SACE Tmax XT circuit-breakers offering for industrial communication are:

- A wide range of protocols are supported; the Ekip Com communication modules enable integration with the most common communication protocols based on RS485 serial lines and the most modern communication systems based on EtherNet™ infrastructures, which guarantee an exchange of data in the order of 100 Mbit/s.

- Installation times reduced to a minimum due to the plug & play technology of the communication modules, which are connected directly to the circuit-breaker terminal box for XT7 and XT7 M and to the Ekip Cartridge with XT2, XT4 and XT5.
- Installation space reduced thanks to the ability to install the communication modules directly inside the circuit-breaker for XT2, XT4 and XT5.
- Redundancy of communication for greater reliability of the system; the circuit-breaker can be equipped with two communication modules at the same time, allowing the information on the buses to be exchanged simultaneously.
- Ready for the smart grid; the Ekip Com 61850 module is the solution for integrating SACE Tmax XT circuit-breakers into the automated systems of electrical substations based on the IEC 61850 Standard without the need for complex external devices.
- Complete supervision of Modbus RTU or Modbus TCP/IP networks via the software for PC Ekip View.

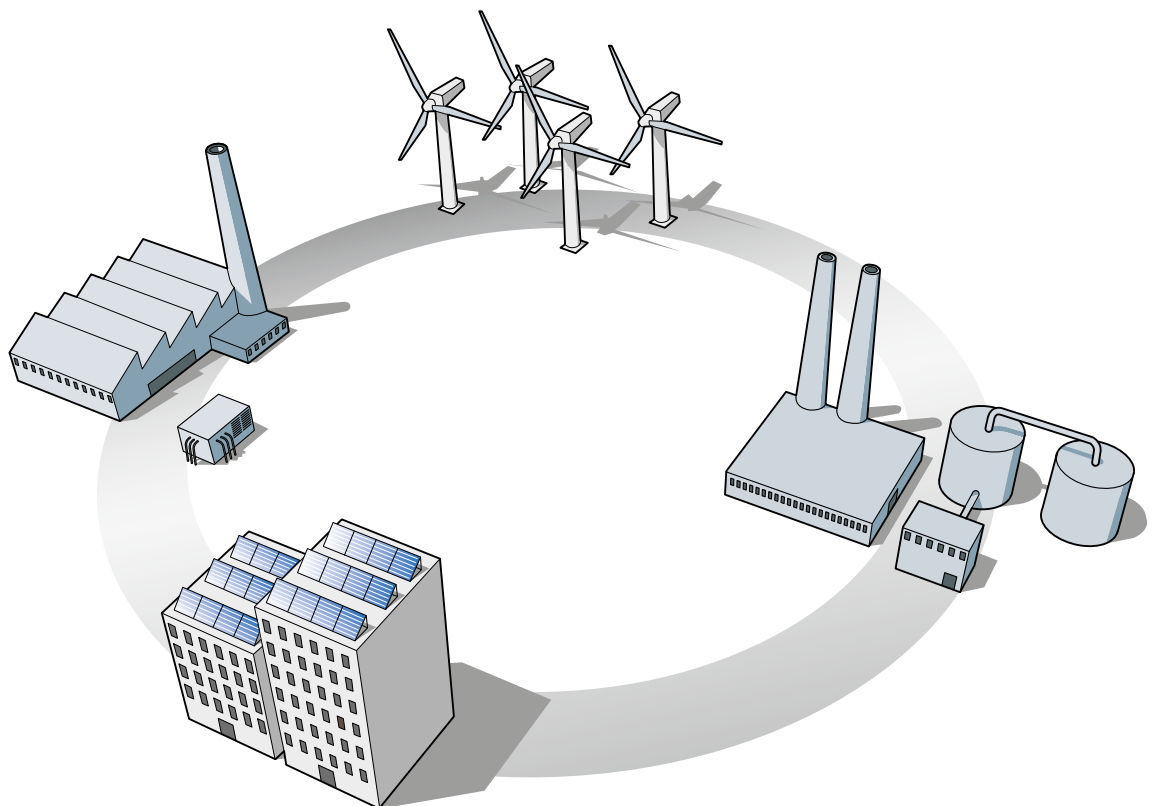

Electronic trip unit	Supervision of the electrical installation
Solution	Ekip Touch/Hi-Touch trip units
	Ekip Touch/Hi-Touch trip units + Ekip com modules
Protocols supported:	
Modbus RTU	Ekip com Modbus RTU
Profibus-DP	Ekip com Profibus
DeviceNet™	Ekip com DeviceNet™
Modbus TCP/IP	Ekip com Modbus TCP
Profinet	Ekip com Profinet
EtherNet/IP™	Ekip com EtherNet™
IEC61850	Ekip com IEC61850
Hub	Ekip com E-Hub
Control functions	
Circuit-breakers opening and closing ¹⁾	●
Measurement functions	
Current	●
Voltage	○
Power	○
Energy	○
Harmonics	○
Network analyzer	○
Data logger	○
Adjustment functions	
Setting thresholds	●
Resetting of alarms	●
Diagnostics	
Protection function alarms	●
Device alarms	●
Protection unit tripping details	●
Events log	●
Protection unit tripping log	●
Maintenance	
Number of operations	●
Number of trips	●
Contact wear	●
Other data	
Status of circuit-breaker	●
Local/remote mode	●

1) Circuit-breakers equipped with MOE-E for the XT2-XT4-XT5 or the Ekip Com Actuator module, or electrical accessories, opening and closing coils and spring charging motor in the case of the XT7-XT7 M. For details, ask ABB.

● Default available ○ Available depending on the trip unit

Ekip E-Hub

This is a DIN-rail mounted communication module for cloud-connectivity. The Ekip E-Hub can collect data throughout the system from air circuit-breakers to molded case circuit-breakers, multimeters, miniature circuit-breakers.

Moreover, it is possible to connect sensors for environmental parameters (temperature, water, gas) via both analog and digital I/O. Modules for Wi-Fi or GPRS connection are provided as optional features.

Electrical switchgear

Ekip Control Panel & Ekip Link

The Ekip Link is a flexible and efficient solution for controlling and supervising low-voltage electrical switchgear.

It is a system that enables SACE Tmax XT circuit-breakers to be connected to the Ekip Control Panel by means of Ekip Link interface modules.

Ekip Link system

The main characteristics of the Ekip Link System are:

- Centralized control: from the Ekip Control Panel display all the main values of the installation (electrical measurements, system diagnostics and trends) can be monitored and controlled.
- Integrated modules: Ekip Link is available also as an internal module, to save space and additional cabling.
- Access via the Internet with any Internet browser using the web server function from the Ekip Control Panel.

- Rapid installation, through the use of standardized EtherNet™ components such as STP cables and RJ45 type connectors.
- Ease of use: thanks to the Ekip Control Panel with a color touch screen, the system mimic panel can be displayed so that the entire installation can be controlled rapidly and intuitively.
- Ready to use: the Ekip Control Panel is supplied with pre-configured software that requires no programming. Just start scanning the Ekip Link system from the operator panel and in a few seconds communication with the connected devices is active.

Ekip Link enables supervision of electrical switchgear with up to 30 ABB circuit-breakers installed. Tmax T and Tmax XT series circuit-breakers equipped with Modbus RTU communication can also be easily integrated into the Ekip Link system using the multi-serial port fitted on the Ekip Control Panel.



Electronic trip unit	Ekip Dip	Ekip Touch/Hi-Touch
Solution	Ekip protection trip units equipped with Ekip Link module + Ekip Control Panel + Standard EtherNet™ components	
Type of trip units connectable	Ekip protection trip units	
Number of trip units connectable to the Ekip Link system	up to 30 ¹⁾	
Data exchange rate of Ekip Link system	100 Mbit/sec	
Supervision and control functions		
Opening and closing of circuit-breakers ²⁾	●	●
Electrical value trends		○
Log of electrical value trends		○
Dynamic installation mimic panel	•	○
Automatic scanning of the Ekip link system	•	○
Centralized synchronizing of time	•	○
Web server function	● ³⁾	● ³⁾
Measurement functions		
Current	●	●
Voltage	-	○
Power	-	○
Energy	-	○
Harmonics	-	○
Network analyzer	-	○
Data logger	-	●
Adjustment functions		
Setting thresholds	-	●
Resetting of alarms	●	●
Diagnostics		
Protection function alarms	●	●
Device alarms	●	●
Protection unit tripping details	●	●
Events log	●	●
Protection unit tripping log	●	●
Transmission of alarms via text message	optional	optional
Transmission of alarms via e-mail	optional	optional
Maintenance		
Number of operations	●	●
Number of trips	●	●
Contact wear	●	●
Other data		
Status of circuit-breaker	●	●
Local/remote mode	●	●

1) Circuit-breakers are equipped with MOE-E for the XT2-XT4-XT5 or the Ekip Com Actuator module, or electrical accessories, opening and closing coils and spring charging motor in the case of XT7-XT7 M. For details, ask ABB.

2) Circuit-breakers equipped with actuation module, electric accessories, opening and closing releases and spring charging motor

3) Two client web accesses included in the license

● Default available

○ Available depending on the trip unit

Electrical system

Software applications

ABB SACE offers software applications that allow the potential of the Ekip electronic trip units to be fully utilized in terms of the management of power, acquisition and analysis of the electrical values, and testing of the protection, maintenance in addition to carrying out diagnostic functions.

Overview of the software

An overview of the software available and the main characteristics are given below:

Software	Functions	Distinctive characteristics
Ekip Connect	<ul style="list-style-type: none"> - commissioning of circuit-breakers - fault analysis - communication bus testing 	<ul style="list-style-type: none"> - simple and intuitive use - integrated with DOC electrical design software - useable via EtherNet™ - automatic updating from the Internet - off-line mode - multi-media (smart phone, tablet or PC)
Ekip View	<ul style="list-style-type: none"> - supervision and control of communication networks - analysis of electrical value trends - condition monitoring 	<ul style="list-style-type: none"> - engineering free - analysis of past trends - customizable reports - access via Internet to the installation - possibility of integrating third party devices
ABB Ability™ Electrical Distribution Control System	<ul style="list-style-type: none"> - monitoring of plants - optimization of the plant - control center 	<ul style="list-style-type: none"> - alerts notification via mail - automatic report for energy efficiency - asset management

Ekip Connect

Ekip Connect is the ABB programming and commissioning software tool that allows the user to unlock the full potential of circuit-breakers, improving the efficiency of the electrical plant.

A circuit-breaker is an essential part of any electrical system guaranteeing that day-to-day processes can be performed safely and continuously. For this reason, it is vital that the installation and use of the circuit-breaker is made as error-free and simple as possible. From commissioning to implementation, through monitoring, testing and analysis, Ekip Connect is the perfect tool for guiding the user in the management of ABB circuit-breakers throughout the entire product life cycle.

Ekip Connect is the ABB commissioning and programming software that allows the potential of Ekip electronic trip units to be fully realized. Using Ekip Connect, the user can manage power, acquire and analyze electrical values and test protection, maintenance and diagnostic functions. Just as SACE EMAX 2 did before, SACE Tmax XT has evolved into a true power manager that has simplified the electrical plant, and the Ekip Connect software has become the user's key to accessing the full capabilities of the breakers.

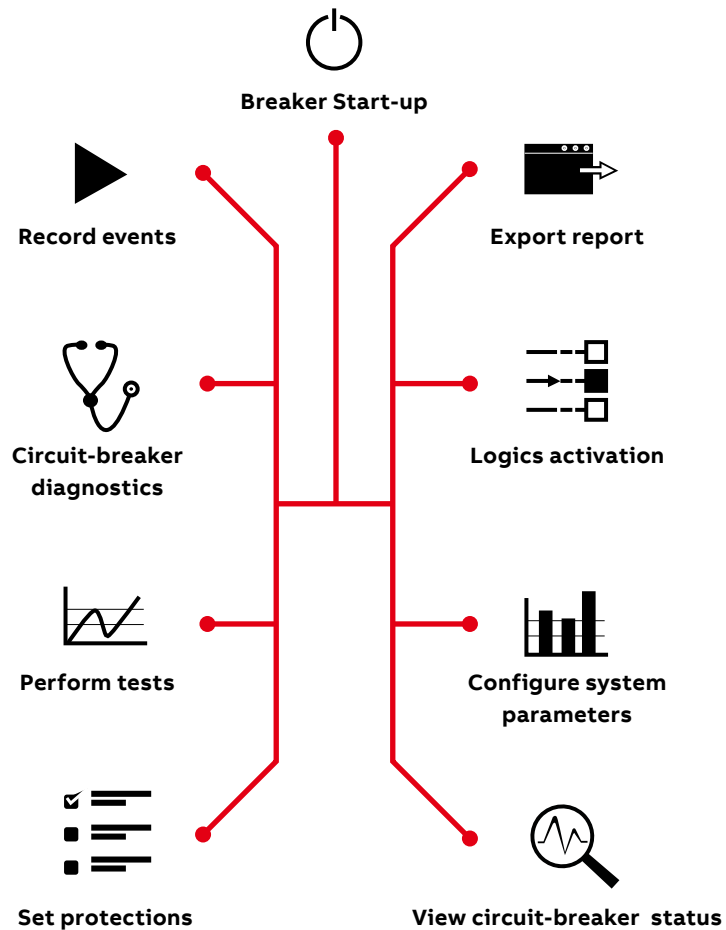

Electrical system

Ekip Connect

—
Panel builders
- 50% commissioning
time



Ease of use

Imagine you are a panel builder and you have to commission a circuit-breaker and you need to save time. Using Ekip Connect it is possible to cut commissioning time up to 50%. Providing a stress-free interaction with the device complexity, Ekip Connect easy-to-use software has all the answers.

Ekip Connect's simple and intuitive interface means that, from the very start, it is possible to easily navigate the tool and access every circuit-breaker operation. At a glance, the user can see all the required information, providing the ability to quickly and effectively assess any situation.

—
Facility managers
100% full exploitation
of the device

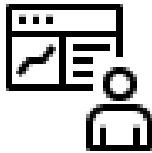

Full exploitation

Imagine you are a facility manager and you need to perform fast and precise diagnosis in order to keep everything under control and avoid failures. Using Ekip Connect you can exploit the full capabilities of your device and thanks to the customizable dashboard you can organize the functions displayed, just the way you want it. It is possible to manage all the circuit-breaker settings and specifications directly with Ekip Connect, making it the perfect instrument for exploring and using the breaker. Diagnostics are easy too: it is possible to consult and download the log of events, alarms and unit trips, thereby facilitating the identification and understanding of any anomalies.

This software is able to manage all ABB low-voltage circuit-breakers equipped with an electronic trip unit, providing full integration of air and molded case circuit-breakers.

—
Consultants/system
integrators
Complex logics at your
fingertips



Product enhancement

Imagine you are a consultant or a system integrator and you want to implement advanced features while avoiding the risk of errors. Using Ekip Connect it is possible to implement complex logics with a few clicks of your mouse.

Adding, setting and managing advanced functions has never been so easy.

Automatic transfer switch logics, load shedding, advanced protection and demand management can be managed and easily set via the Ekip Connect software.

Expand the software features by purchasing and downloading software packages for advanced functions directly using Ekip Connect.

Accessing the full potential of the circuit-breaker is finally possible. Thanks to Ekip Connect software, you can achieve complete utilization of the breaker and more with just a few clicks of your mouse.



Configuration

- Set protections
- Configure system and communication parameters
- Breaker start-up



Monitoring & analysis

- View circuit-breaker status and measurements
- Read events list
- Circuit-breaker diagnostics



Product implementation

- Set advanced protections
- Logics activation
- Enable advanced functions

Test



Testing & reporting

- Check correct functionality
- Perform tests
- Export report

Ekip Connect is available for free download at <http://www.abb.com/abblibrary/DownloadCenter/>

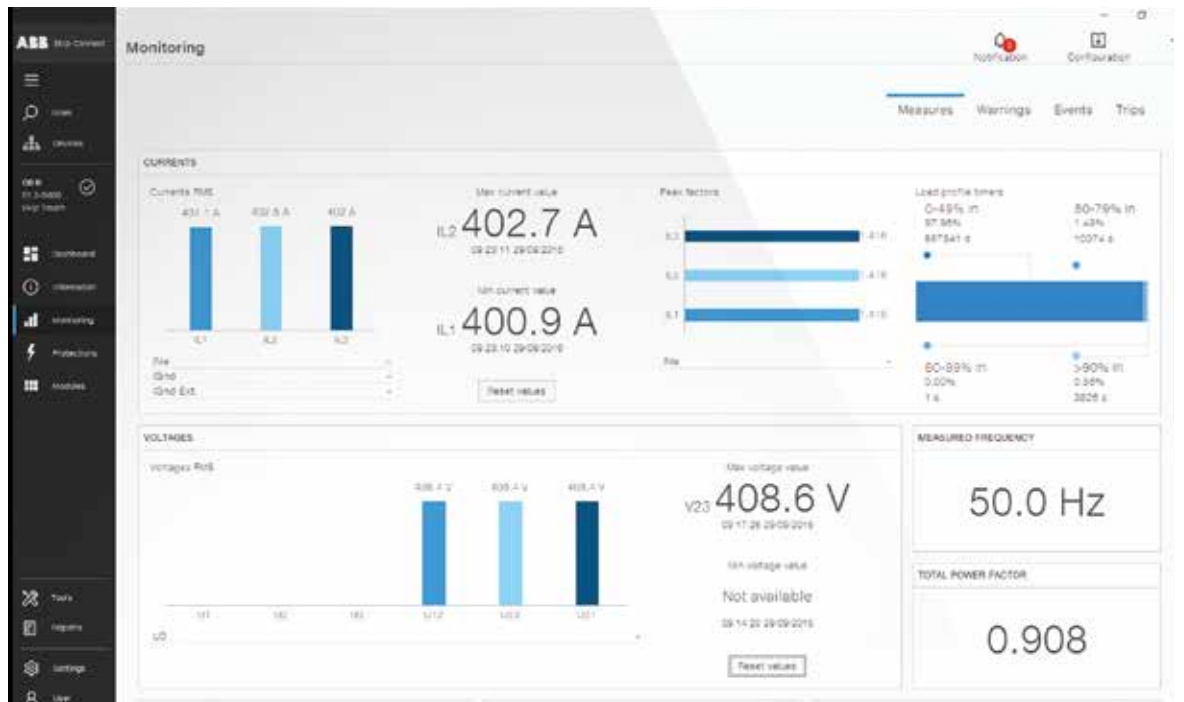

EPiC

With Bluetooth embedded into the trip units it possible to connect rapidly to the EPiC app. Buy additional protection functions or measures, register the product and configure your device. EPiC helps the customer during the commissioning of the system; all system parameters and protection thresholds can be set rapidly in the Ekip Touch trip units thanks to the easy and intuitive navigation pages of the app.

Electrical system

Ekip View

Ekip View is the software for supervising all the devices connected to a communication network that uses the Modbus RTU or Modbus TCP protocol.

Ekip View is the ideal tool for all the applications that require:

- remote control of the system,
- monitoring of power consumption,
- fault detection of the system,
- allocation of energy consumption to the different processes and departments,
- preventative maintenance planning.

The main characteristics of Ekip View are:

- **Free and ready to use** engineering software to guide the user in the recognition and configuration of the protection units without the need for any system engineering supervision.

- **Dynamic mimic panel:** after automatic scanning of the network, for each of the devices found, Ekip View proposes a dynamic symbol that summarizes the most important information (status, electrical measurements, alarms). The extensive library of electrical symbols enables the entire electrical system to be represented in detail.
- **Analysis of trends:** the instantaneous and past trends of currents, powers and power factors are represented graphically and can be exported into Microsoft Excel for detailed analysis.
- **Reports:** advanced reports can be created regarding system and communication network diagnostics. Using the Alarm Dispatcher option, the user can receive the most important notifications via text message.
- **Web access:** to the installation, thanks to Ekip View's Web Server function.

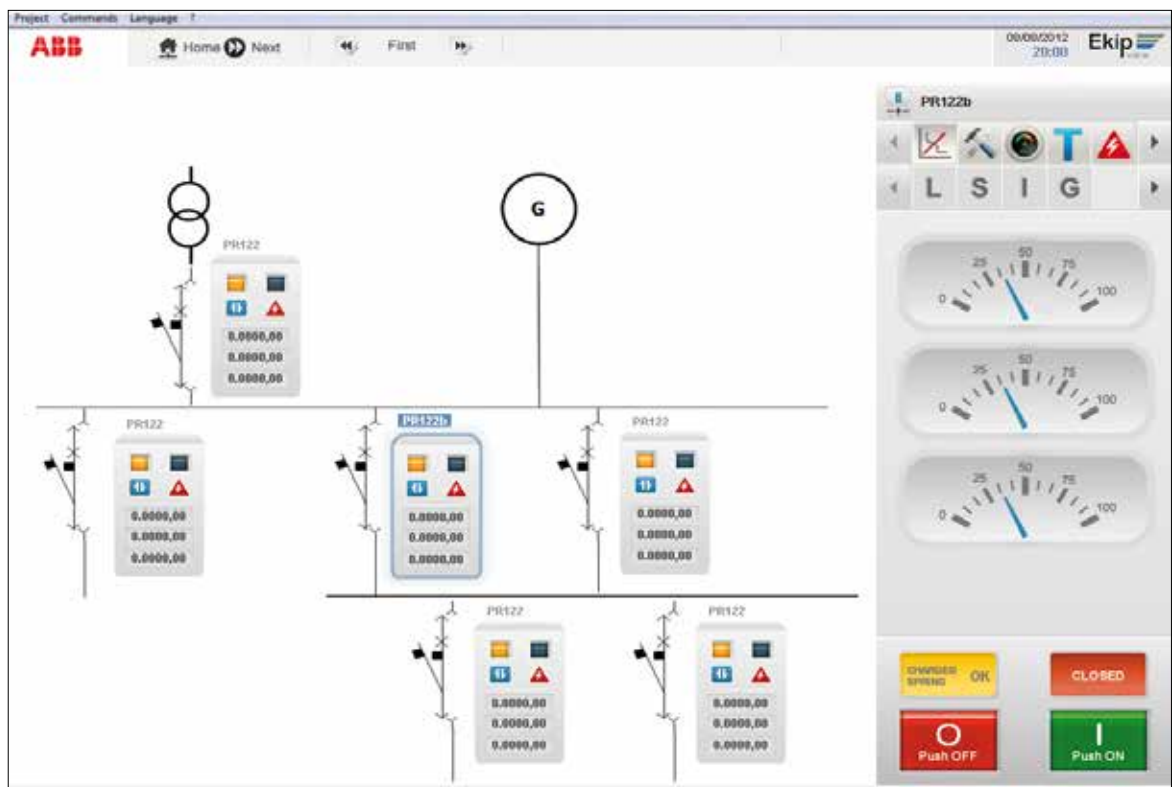

Ekip View Software		
Communication characteristics		
Protocol Supported	Modbus RTU	Modbus TCP
Physical layer	RS 485	EtherNet™
Maximum data exchange rate	19200 bps	100 Mbps
Operating system	Windows XP, Windows 7, Windows Vista	
Devices supported		
Tmax XT and Emax 2 trip units	Ekip com Modbus RS485	Ekip com Modbus TCP
Third party devices	optional ¹⁾	optional ¹⁾
Licenses available	- up to 30 ²⁾ controllable devices	- up to 30 ²⁾ controllable devices
	- up to 60 ²⁾ controllable devices	- up to 60 ²⁾ controllable devices
	- unlimited number ³⁾ of controllable devices	- unlimited number ³⁾ of controllable devices
Supervision and control functions		
Opening and closing of circuit-breakers ⁴⁾	●	●
Electrical value trends	●	●
Log of electrical value trends	●	●
Dynamic installation mimic panel	●	●
Automatic scanning	●	●
Centralized time synchronization	●	●
Web server function ⁶⁾	● ⁵⁾	● ⁵⁾
Measurement functions		
Current	●	●
Voltage	●	●
Power	●	●
Energy	●	●
Harmonics	●	●
Network analyzer	●	●
Data logger	●	●
Adjustment functions		
Setting thresholds	●	●
Resetting of alarms	●	●
Diagnostics		
Protection function alarms	●	●
Device alarms	●	●
Communication system alarms	●	●
Protection unit tripping details	●	●
Events log	●	●
Protection unit tripping log	●	●
Generation of reports	●	●
Maintenance		
Number of operations	●	●
Number of trips	●	●
Contact wear	●	●
Other data		
Status of circuit-breaker	●	●
Local/remote mode	●	●

1) Contact ABB to integrate other devices in the Ekip View software

2) Can be increased

3) Within the physical limit of the protocol used

4) Circuit-breakers are equipped with MOE-E for the XT2-XT4-XT5 or Ekip Com Actuator module, electrical accessories, opening and closing coils and spring charging motor in the case of XT7-XT7 M

5) Two client web accesses included in the license

6) According to the values supported by the trip units

Software and web application

The ABB Ability™ Electrical Distribution Control System is the innovative cloud-computing platform designed to monitor, optimize and control the electrical system.

Part of the ABB Ability™ offering, ABB Ability™ Electrical Distribution Control System, is built on a state-of-the-art cloud architecture for data collection, processing and storage. This cloud architecture has been developed together with Microsoft to enhance performance and guarantee the highest reliability and security. Through a compelling web app interface, ABB Ability™ Electrical Distribution Control System assists the user anytime and anywhere via smartphone, tablet or personal computer making the following operations possible:

- **Monitoring**
Discover plant performance, supervise the electrical system and allocate costs.
- **Optimization**
Schedule and analyze automatic reports, improve the use of assets and make the right business decisions.

- **Control**

Set up alerts, notify key personnel, and remotely implement an effective power management strategy to achieve energy savings in a simple way.

ABB Ability™ Electrical Distribution Control System also provides access to multi-site level monitoring and compares the performances of different facilities simultaneously. In addition, it allows profiling of the users' experience according to the level of access they require. According to the customer needs and application, users can choose between two configurations to connect their system to the ABB Ability™ Electrical Distribution Control System: embedded or external.

The first configuration is the innovative Ekip Com Hub (a cartridge-type module) which needs to be installed on the Tmax XT circuit-breaker.

The second, the Ekip E-Hub module, must be mounted on the DIN-rail.

Solution with Ekip Com Hub

A SACE Tmax XT device equipped with the new Ekip Com Hub establishes the cloud connection for the whole switchboard.

This dedicated cartridge type communication module just needs to be inserted into the terminal box and connected to the Internet. For the XT2, XT4 and XT5 sizes, it is available also as an internal module in case of limited space.





An external solution with Ekip E-Hub

The Ekip E-Hub module can be mounted on a DIN-rail to collect data throughout the system. Moreover, it is possible to connect sensors for environmental parameters (temperature, water, gas) via both analog and digital I/O.

Modules for Wi-Fi or GPRS connection are provided as optional features.

For any further information please visit our website : <http://new.abb.com/low-voltage/launches/abb-ability-edcs>.



Accessories for Ekip Touch/Hi-Touch trip units

Connectivity

Tmax XT circuit-breakers can be integrated perfectly into all automation and energy management systems to improve productivity and energy consumption and to carry out remote service.

They can be equipped with communication units available for use with Modbus, Profibus, and DeviceNet™ protocols as well as with the modern Modbus TCP, Profinet and EtherNet/IP™ protocols. Furthermore, the integrated IEC 61850 communication module enables connection to automation systems widely used in medium voltage power distribution to create intelligent networks (Smart Grids). The modules are available in both solutions, internally and externally mounted. The internal modules are installed directly inside the circuit-breaker and the external modules can be easily installed directly on the terminal box or in the Ekip cartridge, even at a later date. Accurate measurements of current, voltage, power and energy are all available by means of the communication modules.

The trip units themselves can be used as multimeters that display the measurements available, or the Ekip Multimeter can be connected on the front of the switchgear without the need for external instruments.

All the functions are also accessible via the Internet, in complete safety, through the Ekip Link switchgear supervision system and the Ekip Control Panel.

In addition, a full set of information on the plant and circuit-breaker can be made available throughout the cloud via ABB Ability™ Electrical Distribution Control System.

Internal modules

Available with several different communication protocols, the Ekip Com internal module is installed directly inside the circuit-breaker. It allows the circuit-breaker to be integrated in a communication network for supervision and control. Ekip Com internal modules can be used for the XT2-XT4 and XT5. They can be connected to the trip unit when Ekip Touch is used. In other cases (for the Ekip Dip, thermal-magnetic trip unit, or switch-disconnector), the Modbus RTU and TCP, available in the STA version (Stand-Alone), can be still installed inside the circuit-breaker to provide information on the status of the circuit-breaker and remote control (adding the motor operator).



—
XT5 Ekip Com TCP
internal module

Protocols	Ekip Touch/Hi-Touch	Ekip Dip, Thermal-magnetic unit, Switch Disconnector
Modbus RTU	■	■
Modbus TCP/IP	■	■
Profinet	■	-
EtherNet / IP	■	-
IEC61850	■	-



Communication module

External modules

These Ekip Com modules, as well as the internal modules, allow integration in any communication network. They can be used on the XT2, XT4 and XT5 with an Ekip Touch/Hi-Touch trip unit by using the Ekip Cartridge. On the XT7 and XT7 M with an Ekip Touch/Hi-Touch trip unit, they can be mounted directly on the terminal box. Several modules can be used simultaneously enabling systems with different protocols, but also, in case of high reliability requirements, Ekip Com R modules can be installed to guarantee system redundancy. The Modbus RTU, Profibus-DP and DeviceNet™ modules contain a terminating resistor and two dip switches for optional activation to terminate the serial network or bus. The Profibus-DP module also contains a polarization resistor and two dip switches for its activation. When used on the XT7 and XT7 M, communication can be maintained with withdrawable circuit-breakers, even while they remain in the racked-out position, by using Ekip AUP auxiliary position contacts and Ekip RTC ready to close circuit-breaker contacts.

Protocols	Ekip Touch/Hi-Touch
Modbus RTU	■
Modbus TCP	■
Profibus-DP	■
Profinet	■
Ethernet / IP	■
DeviceNet	■
IEC 61850	■



Ekip Cartridge

Ekip Cartridge

The external device connected directly to the Ekip Touch trip unit of XT2, XT4 and XT5 allows most of the connectivity modules to be used including: the Ekip Supply, Ekip Com, Ekip Link, Ekip Signaling 2K and Ekip Synchro check. It is always necessary to install the Ekip Supply module. The Ekip Cartridge is available in two different versions: with 2 slots (1 Ekip Supply + 1 module) or with 4 slots (1 Ekip Supply + 3 modules). If needed, when circuit-breakers in the withdrawable version are used, it is possible to connect the position AUP contacts to the related pins of the cartridge to avoid failure messages on the communication channel. The cartridge can be installed on a DIN-rail everywhere in the panel. The cable that connects the trip unit with the Ekip Cartridge is 1m long.



Ekip Power Supply

Ekip Power Supply

The Ekip Supply module supplies all Ekip trip units and modules present on the Ekip Cartridge or terminal box of the circuit-breaker with several auxiliary power sources (in AC or DC) available in the switchgear. The module permits the installation of the other advanced modules. It can be field installed at any time. Two versions are available according to the control voltage:

- Ekip Supply 110-240V AC/DC
- Ekip Supply 24-48V DC

Accessories for Ekip Touch/Hi-Touch trip units



Ekip Link

Ekip Link

The Ekip Link module enables the Tmax XT circuit-breaker to be connected to an ABB communication system for locally supervising switchgear by means of the Ekip Control Panel and to act as a power controller. It is available in both inside-breaker and external cartridge versions. It is available as:

- an inside-breaker version for XT2, XT4, and XT5 sizes
- a cartridge and terminal box mounted version for XT2, XT4, XT5, XT7 and XT7 M sizes.

In this way, it is possible to have both local supervision of the control panel through the Ekip Control Panel, and supervision of the system through the Ekip Com modules connected to the communication network. The Ekip Link modules are supplied including the Ekip AUP auxiliary position contacts and the Ekip RTC ready to close circuit-breaker contacts.



Ekip Com Hub

Ekip Com Hub

The Ekip Com Hub is the new communication module for cloud-connectivity. A circuit-breaker equipped with Ekip Com Hub can establish a connection with an ABB Ability™ Electrical Distribution Control System for the low-voltage power distribution panel.

This dedicated module is available in two versions: the inside-breaker (for XT2, XT4 and XT5 sizes) and the cartridge/ terminal box mounted versions (for XT2, XT4, XT5, XT7 and XT7 M sizes), even when other modules are present.

For further information related to the ABB Ability™ Electrical Distribution Control System, please visit the dedicated website at <http://new.abb.com/low-voltage/launches/ekip-smartvision>.



Ekip Com Actuator

Ekip Com Actuator

The Ekip Com Actuator module enables the XT7 M circuit-breakers to be opened and closed remotely. The Ekip com Actuator is optional and can be ordered for all Ekip Touch/Hi-Touch trip units equipped with Ekip Com or Ekip Link modules. The Ekip Com Actuator is installed on the front of the circuit-breaker in the right-hand accessories area.

Signaling

Ekip 1K Signalling

The Ekip 1K Signalling module, available for the XT5, supplies one input contact and one output contact for control and remote signaling. It can be programmed from the trip unit display or through the Ekip Connect software and app. Furthermore, when using Ekip Connect, combinations of events can be freely configured. The Ekip 1K Signalling device is installed inside the circuit-breaker in the housing provided on the left down side of the circuit-breaker and it can be used when an Ekip Touch/Hi-Touch trip unit is present.



Ekip Signalling 1K



Ekip 2K Signalling modules

Ekip 2K Signalling modules

The Ekip 2K Signalling modules supply two input and two output contacts for control and remote signaling of alarms and circuit-breaker trips. They can be programmed from the trip unit display or via the Ekip Connect software and app. Furthermore, when using Ekip Connect, combinations of events can be freely configured. Three versions of the Ekip 2K Signalling modules are available: Ekip 2K 1, Ekip 2K-2, and Ekip 2K-3. In this way, a maximum of three modules for XT2, XT4, XT5, XT7 and XT7 M can be installed at the same time into an Ekip Cartridge (for XT2, XT4 and XT5 sizes) or into the terminal box (for XT7 and XT7 M sizes).



Ekip 10K Signalling unit

Ekip 10K Signalling unit

The Ekip 10K Signalling unit is an external device designed for DIN-rail installation. The unit provides ten contacts for electrical signaling of timing and tripping of protection devices. If connected via the Ekip Connect software, the contacts can be freely configured in association with any event and alarm or combination of both. Several Ekip 10K Signalling units (max 4) can be used at the same time on the same Ekip trip unit. The Ekip 10K Signalling module can be powered either by direct or alternating current and can be connected to all the trip units via internal bus or Ekip Link modules.

Output contacts characteristics		Number of contacts	
Type	Monostable	Ekip 1K	Ekip 2K
Maximum switching voltage	150V DC / 250V AC		
Maximum switching current			
30V DC	2A	1 output + 1 input	2 output + 2 input
50V DC	0.8A		
150V DC	0.2A		
250V AC	4A		
Contact/coil insulation	1000 Vrms (1min @50Hz)		

Ekip 10K Signalling unit power supply

Auxiliary supply	24-48V DC, 110-240V AC/DC
Voltage range	21.5-53V DC, 105-265V AC/DC
Rated power	10VA/W
Inrush current	1A for 10ms

Signaling contacts for the XT7 and XT7 M Ekip trip units

With XT7 and XT7 M circuit-breakers, the Ekip trip units can acquire the status of the circuit-breaker ready to close (RTC) and racked-in, test, or racked-out position through the optional Ekip RTC and Ekip AUP signaling contacts. These contacts, housed in the accessories area of the circuit-breakers, are available with the Ekip Dip and Ekip Touch/Hi-Touch.



Signaling contacts for Ekip trip units

Accessories for Ekip Touch/Hi-Touch trip units

Protection

Ekip Synchrocheck

This module enables the control of the synchronism condition when placing two lines in parallel. The module can be used with the Ekip Touch/Hi-Touch trip units. Ekip Synchrocheck measures the voltages from two phases of one line through an external transformer and compares them to the voltage values measured at the circuit-breaker. An output contact is available, which is activated upon synchronism, and enables the circuit-breaker to be closed by means of wiring with the closing coil.

The Ekip Synchrocheck can be installed in the Ekip Cartridge (for XT2, XT4 and XT5) and in the terminal box (for XT7 and XT7 M).



Ekip Synchrocheck

Output contacts characteristics		Number of contacts
Type	Monostable	Ekip Synchrocheck
Maximum switching voltage	150V DC / 250V AC	
Maximum switching current		
30V DC	2A	1 output
50V DC	0.8A	
150V DC	0.2A	
250V AC	4A	
Contact/coil insulation	1000 Vrms (1min @50Hz)	

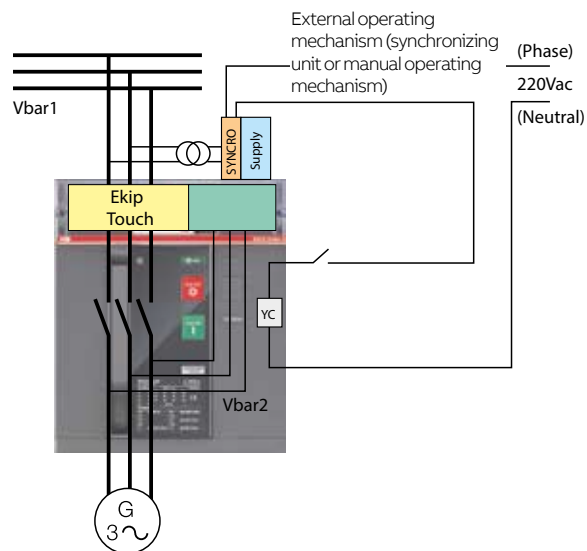



Ekip CI

Ekip CI

This module is an accessory for the Ekip M Touch LRIU trip unit and is needed when the circuit-breaker and the contactor must work in conjunction with each other. In this way the higher number of operations of the contactor are used instead of the circuit-breaker. When the trip unit is set in Normal mode (default mode) by means of the Ekip CI module the contactor is activated in one of the protection trips (excluding I and G protections); if the Heavy mode is set, the trip unit directly opens the circuit-breaker. The auto-reset function allows the actuation status of the Ekip CI to reset automatically after the contactor has tripped owing to the L function, once an adjustable time from 1 to 1000s has elapsed. Auto-reset can occur only in Normal mode. The BACK UP function is available and deals with situations whereby an opening command transmitted to the contactor via module Ekip CI has not been successful. In this case, the Ekip M Touch LRIU trip unit sends an opening command to the circuit-breaker after waiting a set time Tx. The actuation time of the contactor given by the manufacturer must be considered when the Tx time delay setting is entered. The function is active with an auxiliary supply.



Rating Plug

Rating Plug

The rating plugs are field interchangeable from the front on all the trip units and the protection thresholds can be adjusted according to the actual rated current of the system. This function is particularly advantageous in installations that may require future expansion or when the power supplied needs to be limited temporarily (e.g. mobile Gen Set). For the XT7 and XT7 M special rating plugs are also available for residual current protection against ground faults combined with a suitable external toroid. For the XT5, the following rating plugs are available for the two versions of Ekip Touch (400A and 600A). On the Ekip Touch 400 it is not possible to install the 500A and 600A rating plugs.

Nominal Value of the Rating Plug	Ekip Touch/Hi-Touch 400A	Ekip Touch/Hi-Touch 600A
250A	■	■
300A	■	■
400A	■	■
500A	-	■
600A	-	■

■ compatible - not compatible

For XT7 and XT7 M the following rating plugs are available

Ekip Dip LS/I, Ekip Dip LIG, Ekip M Dip I, Ekip G Dip LS/I	
Nominal Value	Standard Rating Plug
600A	■
800A	■
1000A	■
1200A	■

■ compatible

Ekip Dip LSI, Ekip Dip LSIG, Ekip Touch all	
Nominal Value	Standard Rating Plug
600A	■
800A	■
1000A	■
1200A	■

■ compatible

Accessories for Ekip Touch/Hi-Touch trip units

Cables and connectors

XT2-XT4 default supply with Ekip Touch/Hi-Touch trip units

The following items are always provided with the Ekip Touch/Hi-Touch trip units:

- A 24V DC supply / internal bus cable: that supplies the trip unit and connects the Ekip Cartridge and the Ekip Multimeter.
- A side connector to connect the trip unit to the 24V DC/internal bus cable, selectivity cable, and the external neutral cable.

XT5 default supply with Ekip Touch/Hi-Touch trip units

The following items are always provided with the Ekip Touch/Hi-Touch trip units:

- A 24V DC supply / internal bus cable that supplies the trip unit, connect the Ekip Cartridge and the Ekip Multimeter.

When a circuit-breaker with the withdrawable version of the trip unit is required, the following accessories can be used:

- XT2-XT4 connection kit 24V/internal bus/external neutral/zone selectivity
- XT5 connection kit 24V/internal bus (mandatory with the withdrawable version)

Zone Selectivity

To use the zone selectivity function for G and S protections, it's needed to order the zone selectivity cable.

External neutral sensors



—
Current sensor for neutral conductor outside the circuit-breaker

Ekip Dip

The external neutral current sensor (to protect the neutral conductor) is available for 3-pole circuit-breakers equipped with Ekip Dip LIG, Ekip Dip LSI, and Ekip Dip LSIG electronic trip units.

Ekip Touch/Hi-Touch

With this trip unit it is possible to use both current and voltage sensors (to measure or protect the neutral conductor). The current sensor is available only for 3-pole circuit-breakers.

For the XT7 and XT7 M the current sensor is connected through the terminal box; moreover the voltage connection can also be added to the terminal box area by just connecting a cable to the right connection point. For the XT2, XT4 and XT5 it possible to select one of the following solutions:

- a kit for external neutral voltage connections, to only measure the voltage
- a current sensor (CS) for external neutral, to only measure the current
- current sensor + voltage (CS+V) for external neutral, to measure both current and voltage.

The sensors are available with the following nominal currents:

Circuit-breaker	In	Ekip Dip				Ekip Touch/Hi-Touch
		LIG	LSI	LSIG	G-LS/I	
XT2	10	■	■	■	-	-
	25	■	■	■	-	-
	40	-	-	-	-	■
	60	■	■	■	-	■
	100	■	■	■	-	■
	125	■	■	■	-	■
XT4	40	■	■	■	-	-
	60	■	■	■	-	-
	100	■	■	■	-	■
	150	■	■	■	-	■
	225	■	■	■	-	■
	250	■	■	■	-	■
XT5	250	■	■	■	■	■
	300	■	■	■	■	■
	400	■	■	■	■	■
	600	■	■	■	■	■
XT6	600	■	■	■	■	
	800	■	■	■	■	
XT7	600	■	■	■	■	■
	800	■	■	■	■	■
	1000	■	■	■	■	■
	1200	■	■	■	■	■



Homopolar toroid for the earthing conductor of the main power supply



Toroid for differential protection

Homopolar toroid for the earthing conductor of the main power supply

The Ekip Touch/Hi-Touch trip units can be used with an external toroid positioned, for example, on the conductor that connects the star center of the MV/LV transformer to earth (homopolar transformer): in this case, the earth protection is called Source Ground Return. Four sizes of the toroid are available: 100A, 250A, 400A, 800A. The homopolar toroid is an alternative to the toroid for differential protection. This is for the XT7 and XT7 M only.

Toroid for differential protection

Connected to the Ekip Touch/Hi-Touch trip units equipped with a rating plug for differential protection, this toroid enables earth fault currents of 3...30A to be monitored. This is an alternative to the homopolar toroid and should be installed on the busbar system. This is for the XT7 and XT7 M only.

Accessories for Ekip Touch/Hi-Touch trip units

Display and supervision



An Ekip Multimeter Display for the front of the switchgear.

Ekip Multimeter Display for the front of the switchgear

The Ekip Multimeter is a display unit which can be installed on the front of the switchgear for the Tmax XT circuit-breakers equipped with Ekip Touch/Hi-Touch trip units. The device is equipped with a large touch screen display and enables measurements to be displayed. If connected to trip units with a display, the Ekip Multimeter enables the adjustment of parameters and protection thresholds. Up to 4 Ekip Multimeter devices can be connected at the same time to the same Ekip protection trip unit to display currents, voltage, power and energy. The Ekip Multimeter can be connected to a single trip unit and can be powered either by direct current (24-48V DC or 110-240V DC) or alternating current (110-240V AC). It is equipped with a 24V DC output that supplies the trip unit to which it is connected.

Power supply	24-48V DC, 110-240V AC/DC
Tolerance	21.5-53V DC, 105-265V AC/DC
Rated Power	10VA/W
Inrush current	2A for 20ms



An Ekip Control Panel for the front of the switchgear.

Ekip Control Panel for the front of the switchgear

The Ekip Control Panel enables the circuit-breakers connected to the Ekip Link system to be controlled and monitored. The panel is supplied already equipped with supervision software and requires no programming. The Ekip Control Panel requires a 24V DC power supply and is equipped with:

- 2 RJ45 Ethernet ports for connection to the Ekip Link system and to the local network for remote control via web server option
- 1 RS485 serial port for integration with the Modbus network if it is to be used with circuit-breakers from the Tmax series
- 4 USB ports for downloading data.

Accessories for electronic trip units

Testing and programming

Ekip TT testing and power supply unit

This unit is compatible with the Ekip Dip and Ekip Touch/Hi-Touch trip units and allows a trip unit to be supplied so that the last protection device tripped can be viewed directly on the display or identified as the corresponding LEDs light up. The Ekip TT is a device that verifies that the circuit-breaker trip mechanism is functioning correctly (trip test). This device can be connected to the front test connector of any Ekip trip unit.



Ekip TT testing and power supply unit

Ekip T&P testing kit

The Ekip T&P is a kit that includes different components for programming and testing the electronic protection trip units.

The kit includes:

- The Ekip T&P unit;
- The Ekip TT unit;
- Adaptors for the Emax and Tmax trip units;
- A USB cable to connect the T&P unit to the Ekip trip units;
- An installation CD for the Ekip Connect and Ekip T&P interface software.

The Ekip T&P unit is easily connected from your PC (via USB) to the trip unit (via mini USB) with the cable provided. The Ekip T&P unit can perform simple manual or automatic tests of the trip unit functions. Additionally, the Ekip T&P provides the possibility to perform more advanced function testing that allows simulations of very critical applications: real conditions of a system can be accurately represented by considering additional harmonics and shifting of phases. It also generates a test report as well as monitor maintenance schedules.

Ekip Programming module

The Ekip Programming module is used for programming Ekip trip units via PC using the Ekip Connect software that can be downloaded online. The Ekip Programming module, which is connected to the PC via USB, can be useful for uploading/downloading entire sets of parameters for more circuit-breakers both for set-up and maintenance.



Ekip Programming module

Accessories for XT2-XT4 Ekip trip units

Compatible with Ekip LSI and Ekip LSIIG trip units for the XT2 and XT4 sizes



Ekip Display

Ekip Display

The Ekip Display is a unit that can be applied on the front of the solid-state trip unit and shows the current values, alarms, and protection settings.

Main features:

- **Installation:** The Ekip Display can be easily installed on the front of the Ekip LSI and Ekip LSIIG electronic trip units. It is connected by means of the test connector on the front of the trip unit, and fixing is simple and reliable thanks to a specially designed mechanism. This mechanism also provides a practical way of fastening the accessories to the circuit-breaker to prevent undesired access to the dip-switches. Installation can be carried out under any condition, even with the door closed and the electronic trip unit already on and functioning.
- **Functions:** The Ekip Display has four buttons for browsing through the menus. It functions in self-supply mode starting from a current of $I > 0.2 \times I_n$ circulating through at least one phase. Backlighting is activated in the presence of higher loads, thereby allowing better legibility of the visualized information. Rear lighting comes on in self-supply for a current of $I > 0.4 \times I_n$ and is always on when there is an electronic trip unit auxiliary power supply.

The Ekip Display:

- shows the current, voltage, power and energy values;
 - shows the settings of the protection functions in Amperes or in I_n ;
 - shows the protection that has caused the trip unit to trip and the fault current (only when there is 24V external voltage or the Ekip TT unit);
 - allows the trip thresholds of the trip unit to be programmed and the communication parameters to be set on the bus system.
- **Compatibility:** The Ekip Display can be fitted even when the front accessories, such as the motor or direct and transmitted rotary handles etc. are already installed. It is possible to use Ekip TT or Ekip T&P without removing the Ekip Display.



Ekip LED Meter

Ekip LED Meter

The Ekip LED Meter can be applied to the front of the electronic trip unit and displays the current values and alarms.

Main features:

- **Installation:** The Ekip LED Meter can be easily installed on the front of Ekip LSI and Ekip LSIIG electronic trip units. It is connected by means of the test connector on the front of the trip unit and fixing is simple and reliable thanks to a specially designed mechanism. This mechanism also provides a practical way of fastening the accessories to the circuit-breaker to prevent undesired access to the dip-switches. The installation can be carried out under any condition, even with the door closed and the electronic trip unit already on and functioning;
- **Functions:** The Ekip LED Meter provides an accurate indication of the value of the current circulating in the trip unit by means of a scale of LED. Their different colors allow normal operation, pre-alarm and alarm states of the circuit-breaker to be recognized at a glance. It is active in self-supply mode from a current of $I > 0.2 \times I_n$ circulating through at least one phase or when the auxiliary power is available for the electronic trip unit;
- **Compatibility:** The Ekip LED Meter can also be fitted when front accessories, such as the motor, direct and transmitted rotary handles etc. are already installed. It is possible to use the Ekip TT or Ekip T&P without removing the Ekip LED Meter. It is not possible to use the Ekip LED Meter with a withdrawable breaker version.

Accessories for XT2-XT4 Ekip trip units



Ekip Com

Ekip Com

The Ekip Com allows the MOE-E motor operator to be controlled, to determine the ON/OFF/TRIP state of the circuit-breaker and to connect an electronic trip unit to a Modbus communication line. The Ekip Com is available in two versions: one version for the circuit-breakers in the fixed/plug-in version and a version complete with a connector for the fixed moving parts for circuit-breakers in the withdrawable version.

Main characteristics:

- **Installation:** The Ekip Com module is inserted in the right-hand slot of the circuit-breaker and fixing is carried out without any need for screws or tools. Connection to the trip unit is done by using a special small cable which is fitted with a cable guide. The connection towards the Modbus line is made by means of the terminal box to which a 24V DC auxiliary power supply must also be connected, which activates both the module and the protection trip unit. The Ekip Com is supplied always together with the Ekip Display.
- **Functions:** The Ekip Com module can acquire the state of the circuit-breaker remotely and, in combination with the MOE-E motor operator, allows the circuit-breaker to be opened and closed. If combined with a trip unit fitted with a communication function (Ekip LSI or Ekip LSIG), the Ekip Com module allows the trip unit to be connected to a Modbus network, offering the possibility of programming the protections and acquiring the measurements and alarms when it is connected to a control and/or supervision system. When it is connected to the HMI030 unit, it is possible to have this data locally on the front of the switchboard.

Accessories for XT2-XT4 Ekip trip units



HMI030 interface on the front of the switchboard

HMI030 interface on the front of the switchboard

The HMI030 is an interface on the front of the switchboard which is only usable with protection trip units fitted with the Ekip Com.

Main features:

- **Installation:** The HMI030 can be fitted into the hole in the door using an automatic click-in method. In situations where mechanical stress is particularly intense, it can also be installed by using the special clips supplied. It must be connected directly to the Ekip LSI and Ekip LSIG protection trip units with Ekip Com via the serial communication line. The HMI030 requires a 24V DC power supply.
- **Functions:** The HMI030 consists of a graphic display and four buttons for browsing through the menus. This accessory allows you to view:
 - the measurements taken by the trip unit to which it is connected;
 - the alarms/events of the trip unit.Thanks to its high level of accuracy, the device is a valid substitute for conventional instruments without any additional current transformer.
- **Communication:** The HMI030 is provided with two communication lines, to be used alternatively with:
 - Modbus
 - Local BusConnecting the Ekip LSI and Ekip LSIG to the Local Bus allows the Modbus line of the Ekip Com module to connect to a different communication network.

Energy Measurements

5/2 **Introduction**

5/4 **Class 1 accuracy**

Network Analyzer

5/5 Applications

5/7 The first step towards better power
quality: measurement

5/8 Operating principles

Introduction

The Tmax XT circuit-breakers have been designed to manage all low voltage electrical installations with maximum efficiency: from industrial plants, naval applications, traditional and renewable power generation installations to buildings, shopping centers, data centers and communication networks.

Achieving maximum efficiency of an electrical installation in order to reduce consumption and waste requires intelligent management of power supplies and energy. For this reason, the new technologies used in the Tmax XT circuit-breakers with

Ekip Touch trip units allow the productivity and reliability of any installation to be optimized, and at the same time, power consumption to be reduced while fully respecting the environment.



**Class 1 in power and energy measurements**

Before starting to take any action on electrical systems and to analyze the available data, top accuracy on measurements must be guaranteed.

Thanks to the Ekip Touch trip units, the SACE Tmax XT range of circuit-breakers guarantees extremely accurate measures, in compliance with the relevant IEC 61557-2 Standard.

Network Analyzer

The quality of the power supply is an important factor to consider in order to preserve the loads, to avoid equipment malfunctions, and to optimize energy consumption. The power quality of a power system is never a perfect sinusoidal waveform, distortions and harmonics are always present. Several parameters that cause reductions in power quality can be monitored and controlled thanks to the Network Analyzer embedded function. In this way, the use of expensive external devices can be avoided.

Class 1 accuracy

With the Ekip Touch/Hi-Touch trip units the embedded measurement functionalities allow the measurement of power and energy to a Class 1 degree of accuracy, as specified by the IEC 61557-12 Standard, avoiding the need of additional device, saving costs, space and installation time.

With the Ekip Touch/Hi-Touch trip units, measurements of power and energy to a IEC 61557-12 Standard compliant, Class 1 level of accuracy, are guaranteed by the embedded measurement functionalities. Thus, there is no need for additional devices, with consequent advantages in terms of cost savings, space reduction and installation time optimization.

When energy needs monitoring, even a minimal percentage of errors would result in a waste of money. Accuracy is everything and depends on the design and manufacturing quality of solution used. The Tmax XT with Ekip Touch trip units guarantee 1% accuracy for power and energy monitoring.



Thanks to the extremely accurate Rogowsky coil, ABB Ekip Touch/Hi-Touch trip units are able to guarantee Class 0.5 for voltage and current measurements and Class 1 for active power and energy measurements, complying with and certified by the IEC 61557-12 Standard (see Chapter 3 for more detailed information about the accuracy and the monitored parameters of the electrical system). IEC 61557-12 can be applied to both AC and DC electrical networks up to 1000 V AC or 1500V DC.

Moreover, an upgrade of the device is always guaranteed to be quick and easy: the measurement functions not included in an installed trip unit can be downloaded directly from the ABB Ability Marketplace™ via Ekip Connect Mobile, thus allowing new system requirements to be met with ease.

Measurement data can be displayed in several ways:

- On the embedded display on the trip unit
- On a smartphone via Bluetooth (Ekip Connect Mobile App)
- Using the Ekip Connect software on a PC
- On an Ekip Multimeter external display
- On a cloud-platform thanks to ABB Ability™ EDCS
- In the supervision system (ex SCADA) thanks to several communication protocols
- On the control panel display

Network Analyzer

Thanks to the Network Analyzer function available in all Ekip Touch/Hi-Touch trip units, the quality of energy based on harmonics, micro-interruptions or voltage dips is monitored without the need for dedicated instrumentation.

Thanks to Ekip Touch/Hi-Touch Network Analyzer, effective preventive and corrective actions can be implemented through accurate analysis of faults, thereby improving the efficiency of the system.

Applications

Electrical equipment is designed for optimum operation under constant and uniform voltage level, as close as possible to the rated value. In addition, industrial equipment, working on a three phase supply, requires the three phase voltage levels to be balanced. Power quality is a description of how well a power system complies with the above ideal conditions. Power quality issues can have negative consequences on the components and on the energy efficiency of the network. Thus, power quality monitoring is becoming more important in modern power systems, and will be a key part of the smart grid of the future.

In particular, power quality evaluation includes the following aspects:

- Deviations of voltage average value from the rated value
- Short decreases (sags) or increases (swells) of voltage value
- Voltage unbalance, i.e. difference in voltage values between different phases
- The presence of current and voltage harmonics.

Distortions of the voltage value (sags, swells) and/or frequency can have fatal consequences, especially for process industries, leading to possible production stoppages with consequently expensive downtime, damage to motor drives and damage to PLCs. Examples of process industries that can be badly hit by voltage instabilities include the plastics, petrochemicals, textiles, paper, semiconductor, and glass industries.

Voltage sag is defined as when the value of the voltage is reduced below the rated one for a certain amount of time. Similarly, voltage swell is defined as when the voltage is increased above the rated value for a certain amount of time.

RMS voltage values and frequency are two fundamental features of a voltage signal, but the “purity” of the voltage waveform is also an important point. An ideal voltage waveform should be a perfect sinusoid, but this is not something that is normally seen in the real world. Frequencies other than the fundamental are always present.

These frequencies are called harmonics: a harmonic of a signal is a component frequency of the wave spectrum that is a multiple of the fundamental frequency. Harmonic content is an issue that is becoming increasingly debated: technological developments in the industrial and household field have led to the spread of electronic equipment which, due to their operating principles, absorb a non-sinusoidal current (non-linear load). Such current causes a non-sinusoidal voltage drop on the supply side of the network with the consequence that the linear loads are also supplied with a distorted voltage.

Network Analyzer

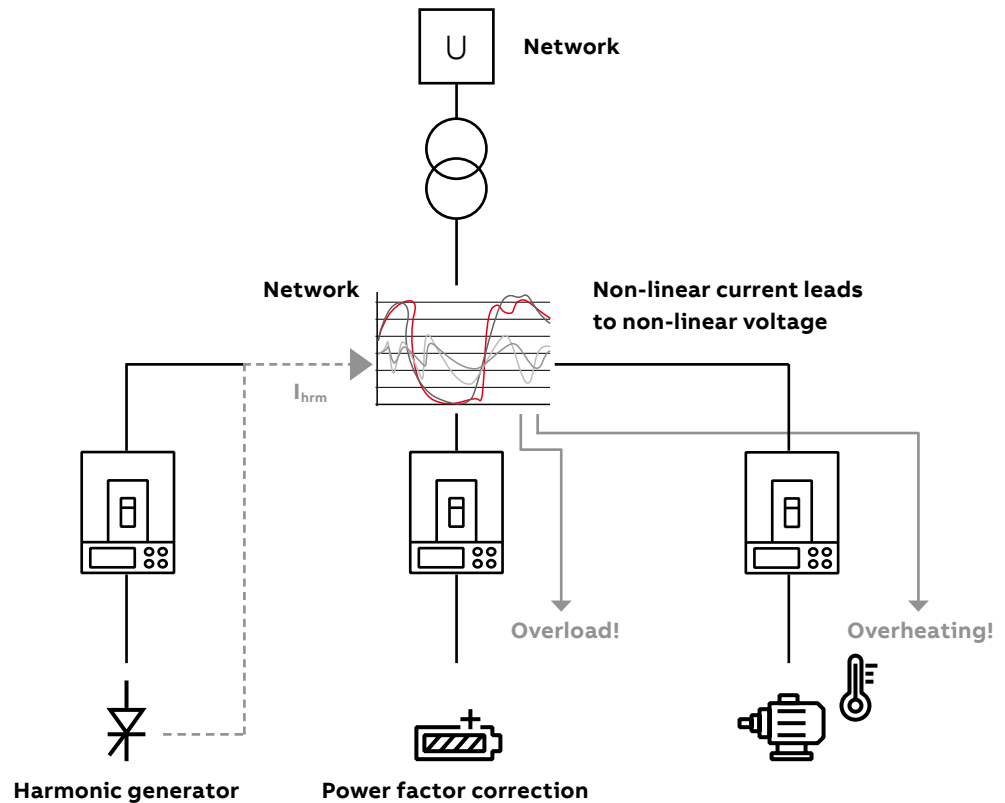

Power electronics produce harmonic content that can affect other loads in the plant: the result can be an overheating of the asynchronous motor and an overload (that could lead to a trip of the protecting MCCB) on the power factor correction capacitors.

To get information about the harmonic content of voltage and current waveforms and to take measures if such values are high, a dedicated index has been defined. The total harmonic distortion (THD) of a signal is a measurement of the harmonic distortion present.

The first step towards better Power Quality: measurement

A Power Quality monitor is the most commonly used tool for detecting voltage sags and power quality issues. Measurement is the first step for checking the status of the installation and starting the root cause analysis. Power Quality measurements and related instrumentation are described in specific industrial Standards such as IEC61000-4-30 and IEEE 1250. For the first time, thanks to the Ekip Touch trip units for the Tmax XT, the power quality monitor is embedded in a low voltage molded case circuit-breaker. The Network Analyzer function complies with the prescriptions of IEC 61000-4-30 and IEEE 1250.

The Network Analyzer function allows the user to set controls on the voltage in order to analyze the operation of the system: any time a control parameter exceeds a preset threshold, an alarm is generated. The accuracy of voltage measurements by the Tmax XT is excellent at 0.5%. The Tmax XT Network Analyzer complies with IEEE 1250-2011, Section 3 for the monitoring of the voltage value, unbalance and harmonic content, which is the equivalent of IEC61000-4-30 Class S for voltage values and unbalance and Class B for the harmonic content.

Network Analyzer

Hourly average voltage value

Short voltage interruption

Short voltage spikes

Slow voltage sags and swells

Voltage unbalance

Harmonic analysis

Referring to the voltage sag ambit, as an example, the Network Analyzer function has the ability to control three kinds of sag classes, defined by the user:

Parameter	Description
Sag Threshold (First Class)	This defines the first alarm threshold. It is expressed as % Un.
Sag Times (First Class)	In the event of dropping under the first alarm threshold, this defines the time beyond which the alarm counter is increased.
Sag Threshold (Second Class)	This defines the second alarm threshold. It is expressed as % Un.
Sag Times (Second Class)	In the event of dropping under the second alarm threshold, this defines the time beyond which the alarm counter is increased.
Sag Threshold (Third Class)	This defines the third alarm threshold. It is expressed as % Un.
Sag Times (Third Class)	In the event of dropping under the third alarm threshold, this defines the time beyond which the alarm counter is increased.

Two different types of counters for each power quality monitoring function are made available directly on the trip unit touch screen: one is a cumulative counter, which stores all the alarms (for example, all the voltage sags) from the beginning, and one is a 24h counter, that shows the alarms in the last 24 hours.

With the optional communication module (Modbus, Profibus, Profinet, etc.) eight counters for each power quality monitoring function are available: one is the cumulative and the other seven are the daily counters of the last seven days of activity.

Network Analyzer

Operating Principle

The Network Analyzer function performs continuous monitoring of the quality of energy, and shows all results through a display or communication module. In particular:

- **Hourly average voltage value:** in accordance with international Standards, this must remain within 10% of the rated value, but different limits can be defined according to the needs of the installation. The positive sequence voltage is compared with the limits. If the limits are exceeded, the Ekip Hi-Touch generates a signaling event. The number of these events is stored in a suitable counter. The counter values are available for each of the last 7 days, as well as the total. The measures available are the positive and negative sequence voltages and positive and negative sequence currents of the last interval monitored. The time of the calculation of the average values can be set between 5 minutes and 2 hours.
- **Interruptions / short dips in voltage:** if the voltage remains below a threshold for more than 40ms, the Ekip Hi-Touch generates an event that is counted in a dedicated log. The voltage is monitored on all lines.
- **Short voltage spikes** (voltage transients, spikes): if the voltage exceeds a threshold for 40ms, set for a pre-determined time, the Ekip Hi-Touch generates an event that is counted.
- **Slow voltage sags and swells:** when the voltage strays outside a range of acceptable limit values for a time greater than the one set, the Ekip Hi-Touch generates an event that is counted. Three values can be configured for voltage sags and two for voltage swells, each associated with a time limit: this enables verification of whether the voltage remains within a curve of values that are acceptable by equipment such as computers. The voltage is monitored on all lines.

- **Voltage unbalances:** if the voltage values are not equal or the phase displacements between them are not exactly 120°, an unbalance occurs, which is manifested with a negative sequence voltage value. If this limit exceeds the threshold value set, an event is stored which is counted.
- **Harmonic analysis:** the harmonic content of voltages and currents, measured to the 50th harmonic, as well as the value of the total harmonic distortion (THD), are available in real time on the display or through the communication modules. The Ekip Hi-Touch also generates an alarm if the THD value or a magnitude of at least one of the harmonics exceeds the values set. The voltage and current values are monitored on all phases.

All information can be displayed directly on the screen (for the XT5, XT7, XT7 M) or on a smartphone, a PC or in a network system with any of the communication modules. This is an embedded function of Ekip Touch/Hi-Touch trip units and analyzes important parameters of the distribution network including:

- The average voltage value
- Short voltage interruptions and spikes
- Slow voltage sags and swells
- Voltage unbalance
- Harmonic analysis

Solutions

- 6/2** **Introduction**
- 6/4** **Power Controller**
- 6/7** **Interface Protection System and
Interface Device**
- 6/9** **Adaptive protections**
- 6/11** **Load Shedding**
- 6/13** **ATS function**
- 6/15** **Synchro Reclosing**

Introduction

The use of renewables has been growing over the last 10 years reducing the polluting emission for a greener world. Due to environmental changes, people have started to think about ecology and sustainability, increasing their awareness of energy self-consumption and increasingly concerned about energy efficiency.

The Tmax XT is the first smart moulded case circuit-breaker enabling all-in-one solutions that combine advanced protection, programmable logics, full connectivity, easy integration and comprehensive energy management in a single revolutionary device or at the local generation side.

Installed downstream the MV/LV transformer, Tmax XT works like a certified interface protection system in order to check the main grid conditions and disconnect the user's plant whenever the grid voltage and frequency are out of the ranges prescribed by the connection local standard.

The Tmax XT and its adaptive protections recognize the network changes and automatically set new thresholds to guarantee protection and coordination in on-grid and off-grid conditions.

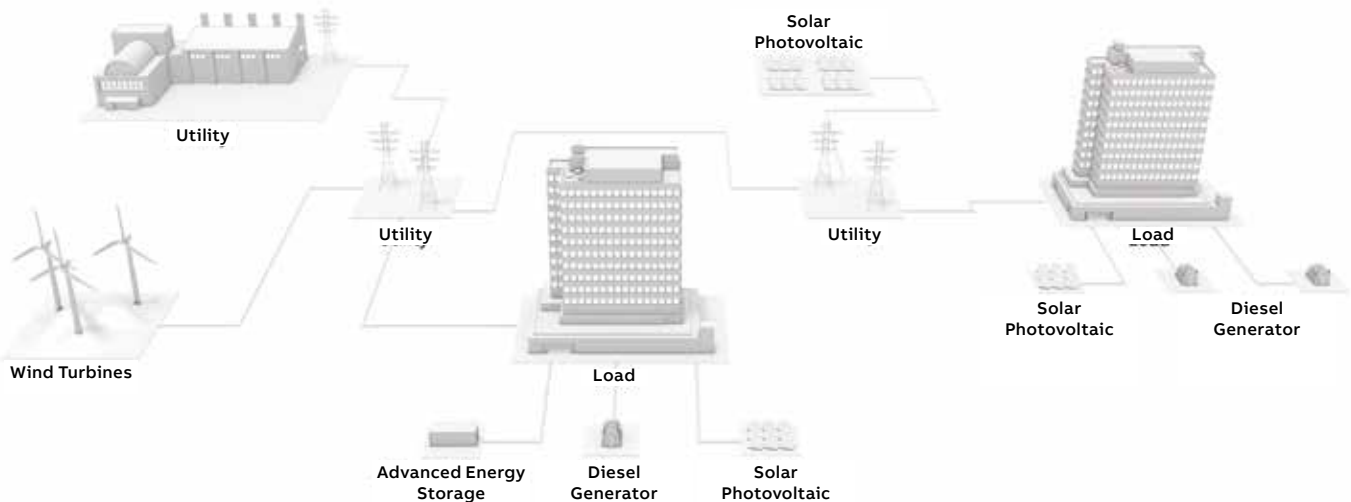

The Tmax XT is able to integrate programmable logics for protection features and Automatic Transfer Switching (ATS) in one device. This unique integrated solution avoids the usage of other external control units, guaranteeing a minimal switchgear footprint and saving commissioning time.

A strong reduction in the connection wiring simplifies the installation and commissioning phase.

The load shedding embedded algorithm is able to manage the power system for comprehensive microgrid energy management.

Before the transfer from the main grid to the local line, selected loads are shed to support power balance. Using a frequency slope, the Tmax XT disconnects loads only in cases of emergency unbalanced conditions.

As the main grid is stable, thanks to the **Synchro Reclosing** logic, it is possible to synchronize the plant voltage and frequency to reconnect it. In grid-connected operations, the Tmax XT manages the **Power Controller** algorithm to shave peaks and shift loads in order to optimize system performance and productivity.

The advanced features of the Tmax XT are easily customized thanks to commissioning software tools which do not require high level engineering competencies. Ready to use templates enable the download of all the logics directly in the trip unit. The solutions are plug & play, increasing modularization and standardization for design and installation. The advanced functionalities which have been developed and integrated in the Tmax XT are described in the following compatibility table.

	Interface Protection	Load Shedding	Automatic Transfer Switch	Synchro Reclosing	Power Controller
Interface Protection	●	●			●
Load Shedding	●		●	●	●
Automatic Transfer Switch		●	●	●	●
Synchro Reclosing		●	●	●	●
Power Controller	●	●	●	●	●

Power Controller

The Tmax XT is able to control loads and generators to ensure bill savings and enable demand response according to power management strategies.

Purpose

Thanks to the Power Controller software, Tmax XT manages the power to shave the peaks and shift the loads. In this way, it is possible to cut electricity bills, increase energy efficiency by up to 20% and be ready for demand response programs.

The Power Controller function is based on a patented calculation algorithm that allows a load list to be controlled via the remote command of relevant switching devices or control circuits according to a defined priority. The user (locally), or the load aggregator / utility (remotely) - define the load disconnection priority based on their own requirements and types of loads.

The algorithm is designed for the anticipated average power absorption which can be set by the user over a determined time interval.

Whenever this value exceeds the fixed power, the Power Controller function intervenes to bring it back within the limits.

This system can be realized with a single Tmax XT Control or Tmax XT Control+ Standard equipped with this function and installed as the low voltage plant controller.

Furthermore, the control unit, not only manages passive loads, but it can also manage a reserve generator.

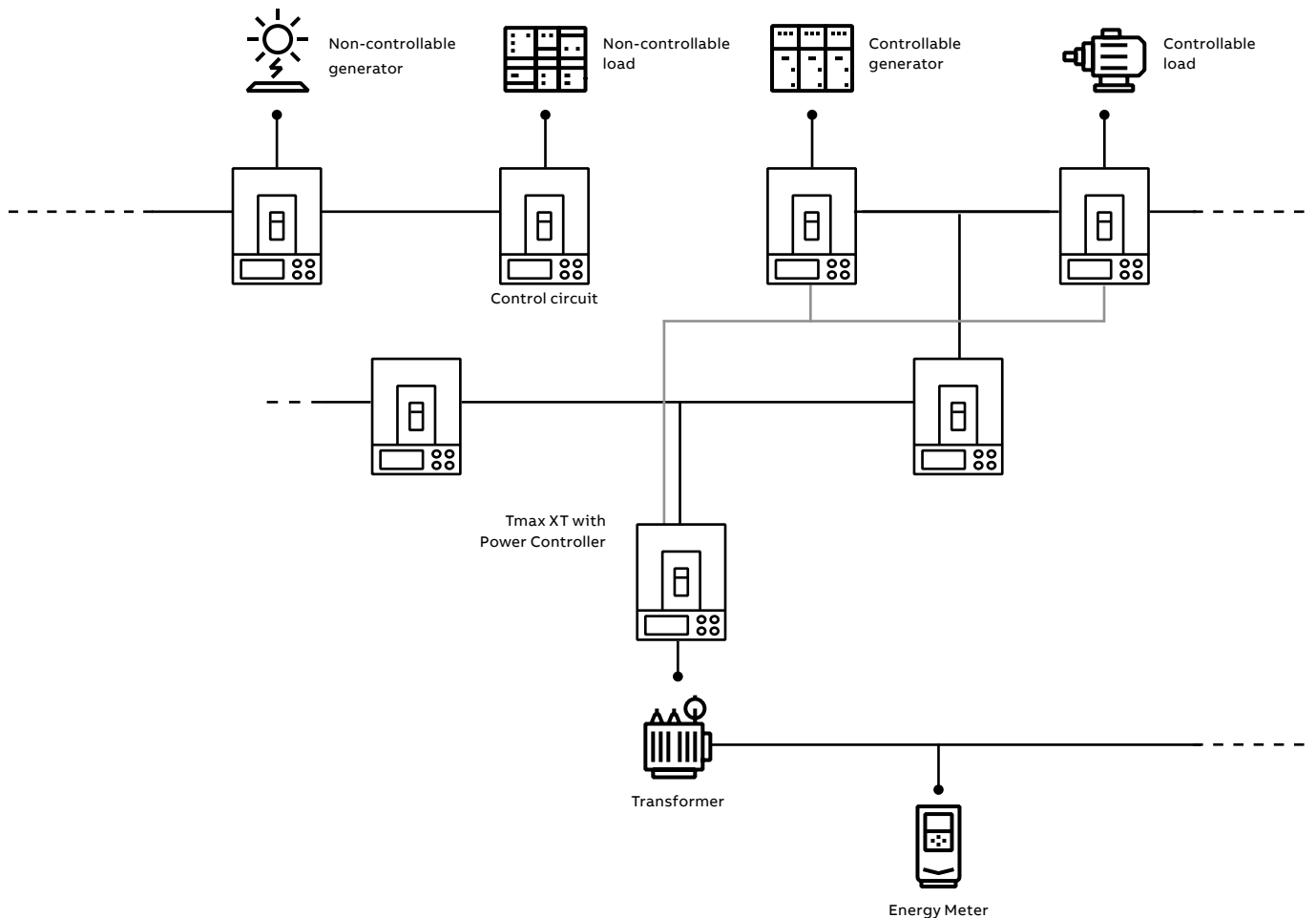

The Ekip Power Controller can be used with all Ekip Touch/Hi-Touch trip units of the Tmax XT series and effectively helps to improve energy efficiency by managing the entire low-voltage electrical system. It is fully able to adapt the demand for power according to the availability of the energy source, the time of day and the costs indicated in the current pricing plan.

In this way, the Ekip Power Controller is able to maintain power consumption within the limits defined, thereby optimizing the costs of managing the installation and reducing emissions.

Commands sent to downstream devices can be performed in two different ways:

- through the wired solution, by commanding the shunt opening/closing releases or acting on the motor operators of the loads to be managed;
- through a dedicated communication system.

The ability to control the loads according to a list of priorities already defined provides significant advantages from both the economic as well as technical points of view:

- **Economic:** energy consumption optimization is focused on the control of the costs linked in particular to penalties that are levied when the contractual power is exceeded or when the contractual power is increased by the Distribution System Operator (DSO) as a consequence of exceeding the limit repeatedly.
- **Technical:** the solution provides the ability to absorb power over the contractual limits for shorter periods and also the management and the control of the power consumption over long periods of time. Thus, it is possible to reduce the likelihood of malfunctioning due to overloads, or worse, complete inefficiency of the entire plant due to tripping of the LV main switching device.

The exclusive Power Controller function available on the new Tmax XT circuit-breakers monitors the power, keeping it below the limits set by the user. As a result of this more effective use, the peak of power consumed can be limited allowing savings on electricity bills.

The Power Controller, patented by ABB, disconnects non-priority utilities, such as electric car charging stations, lighting or refrigeration units, during the times when consumption limits need to be respected, and connects them again as soon as it is appropriate. When required, it automatically activates auxiliary power supplies such as generator sets. No other supervision and control system is required: it is sufficient to set the required load limit on the Tmax XT, which can control any switching device located downstream, even if it is not equipped with a measurement function.

Application examples

Electricity bill savings, demand response, and avoiding power overloads are the typical scenarios where the Power Controller is used.

The Power Controller is commonly used in office buildings, shopping malls, hotels, campuses, waste and water industries or any plant that works like a low voltage microgrid.

Power Controller

Benefits

Thanks to the Tmax XT with the embedded Power Controller, the following benefits are guaranteed:

- **Reduction of energy costs with minimum impact**

The loads are disconnected from the power supply for short periods, in the minimum number necessary and in a fixed order of priority, enabling power consumption peaks to be limited. This allows the contract drawn up with the energy provider to be renegotiated, reducing the power allocated, with a consequent reduction in total energy costs.

- **Power limited only when necessary**

The Power Controller function manages up to four different time bands. It is therefore possible to respect a particular power limit according to whether it is during the day (peak) or night (off peak). In this way, consumption during the day when rates are at their highest can be limited.

- **Easy of use**

The Power Controller function allows the installation to be managed efficiently with a simple architecture. Thanks to a patented design, it is sufficient to measure the total power of the installation without having to measure the power consumed by each load. Installation costs and times are thereby reduced to a minimum.

The Power Controller function does not require the writing, implementation or testing of complicated programmes for PLC or computer because the logic has already been implemented in the protection unit and is ready to use. It is sufficient to set the installation parameters from a smartphone or directly from the switching device display.

Thanks to the integrated communication modules, the Power Controller can receive the maximum absorbable power directly from the medium voltage control system, determining consumption for the next 15 minutes. According to the information received, the Ekip Power Controller manages the switching off of non-priority loads or the switching on of reserve generators. The software gives maximum priority to non-programmable preferred energy sources, such as wind and solar, and they are therefore considered uninterruptable. In the event that the production of internal power to the controlled network is reduced, due, for example, to decreased production of solar power, the Power Controller will disconnect the necessary loads to respect the set consumption limit.

This benefit is used, for example, in installations with a system of cogeneration. Indeed, the Power Controller controls the total consumption drawn from the electrical network, disconnecting non-priority loads when generation is reduced and reconnecting them when generator power is sufficient not to exceed limits.

There are multiple advantages of the system including: reduction in energy costs, maximum use of local generation and greater overall energy efficiency.

Interface Protection System

The Tmax XT embeds both the functions of the Interface Protection System and Interface Device in a single device.

Purpose

The connection of active users to a power utility is always subject to Standard compliance. The Interface Protection System is a device with dedicated protections that are able to satisfy these requirements. In particular, the generating units installed in the user's plant must be disconnected from the grid whenever the voltage and frequency values of the grid itself are out of the ranges prescribed by the Standards. This disconnection is usually carried out by means of an interface device that trips after receiving an opening command provided by an external interface protection system. ABB has developed an integrated solution which embeds both the functions of ABB's Interface Protection System and Interface Device in a single device. This advanced feature is possible thanks to the integration of the several interface protections into the Ekip Hi-Touch trip unit installed on board the Tmax XT. Today the Tmax XT complies with the CEI 0-16 Standard, which is the most important Standard concerning the connection of active users. A lot of local Standards use the CEI 0-16 as a reference.

Application examples

ABB has been able to integrate the following functions in a single device to be used in the scenarios described below. Thanks to these embedded functions, the number of devices to be installed is reduced, with consequent space saving inside the switchboard. The Tmax XT with its embedded Interface Protection System have been tested and certified in compliance with the CEI 0-16 Standard and are suitable for the following scenarios.

The Tmax XT as the main protection unit for a microgrid

In such a scenario, the Tmax XT with its embedded functions can act as an Interface Protection System (IPS). In case of IPS tripping, the microgrid's main-downstream Tmax XT unit remains active thanks to both the local generation and the load shedding feature also embedded in the main unit.

The Tmax XT as local generation protection unit

In this scenario, there are non-operating loads under islanding conditions, so, when there is a utility outage, the Tmax XT detects that the voltage and frequency values are out of the prescribed range. According to the CEI 0-16 Standard, local generation must be disconnected from the utility, so the Tmax XT opens, acting as interface device, thanks to the embedded IPS. In this condition, loads do not operate as there is no voltage on the secondary of the MV/LV transformer and no local generation connected.

Benefits

Thanks to the Tmax XT with the embedded Interface Protection System, the following benefits are guaranteed:

- The Tmax XT performs interface protection with any switching device, also ensuring reclosing operations.
- If the Tmax XT is installed on the generator feeder, the unit will be able to perform the dual function of an interface protection system and generator device thanks to the integrated Interface Protection System in the Ekip G Hi-Touch trip unit.
- Ease of use, thanks to the Ekip Connect software which allows an immediate and intuitive commissioning phase.

Interface Protection System

—
The Tmax XT as the main protection unit for a microgrid

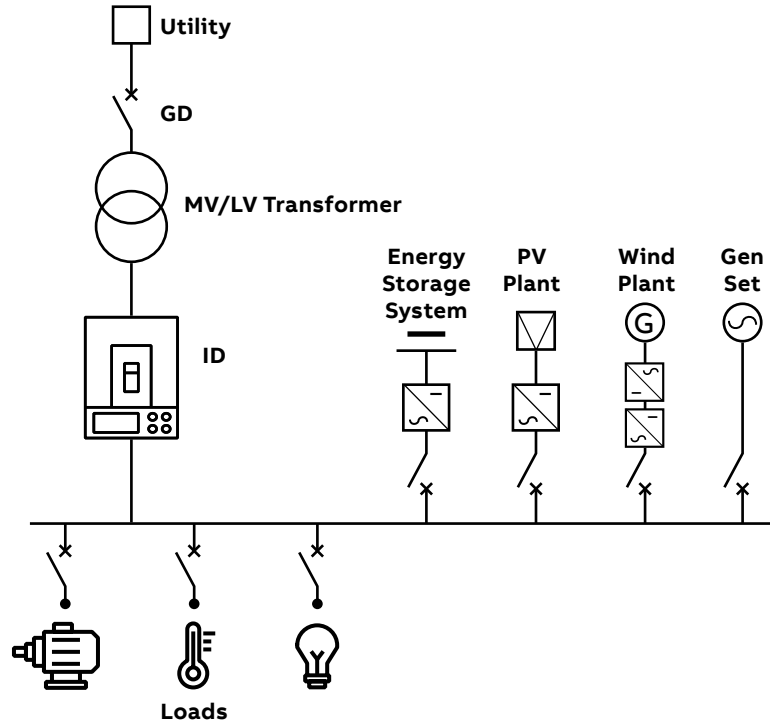

—
The Tmax XT as local generation protection unit

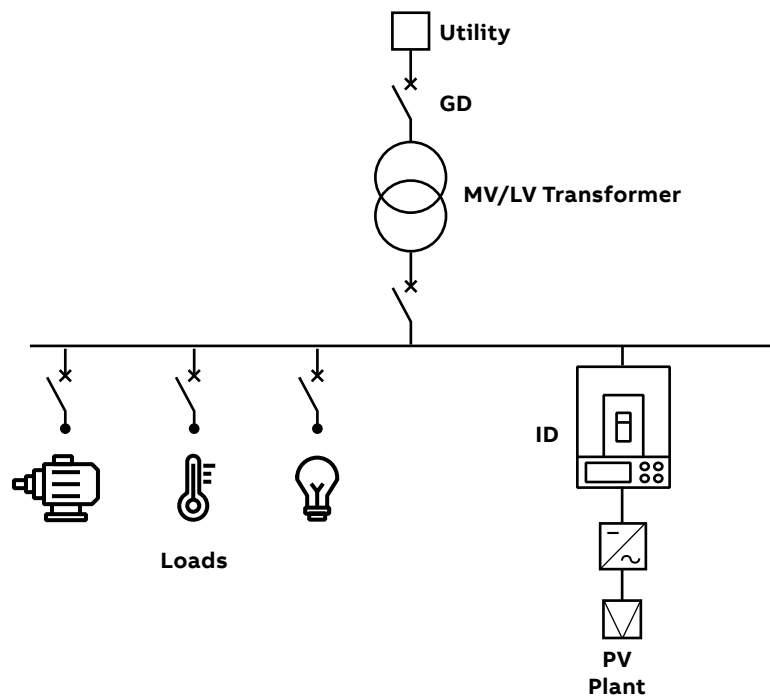

Adaptive Protections

The Tmax XT adds a dual setting capability to the switching device to ensure continuous coordination

Purpose

User's plants can work as a LV microgrid thanks to the energy produced by renewable and local power sources, in particular as a consequence of the lack of an utility power supply, e.g. due to a fault on the MV voltage side. In order to still guarantee a high level of selectivity and continuity of service, it is important to take into account the variation of the short-circuit power when moving from on-grid to off-grid operation.

Indeed, during grid connected conditions the fault current on a microgrid feeder is also supplied by the utility, thus resulting higher than the one supplied only by local generation during islanded conditions. As a result, it is desirable that several protection thresholds of the units can be automatically changed during the transition to islanding conditions.

Application example

A plant is connected to the MV utility by means of a MV/LV transformer. If the utility shuts down, the plant will become a microgrid supplied by a local generator G, which will feed priority loads by using the load shedding feature of the Tmax XT.

In a grid-connected condition, the generator G is disconnected. With reference to Fig. 1:

- Circuit-breaker A is closed
- Circuit-breaker B is open
- Circuit-breakers at position C are closed. The protection of the circuit-breaker at C that supplies the feeders at D are adjusted using "Set A" of the Tmax XT unit.
- Circuit-breakers at position D are closed
- Circuit-breaker E is closed
- Molded case switch QS1 is closed
- All loads are supplied.

The circuit-breakers at position C are selectively coordinated with the upstream main circuit-breaker A, supplied by the utility, and the downstream load circuit-breakers at position D (see Fig. 2 at the following page).

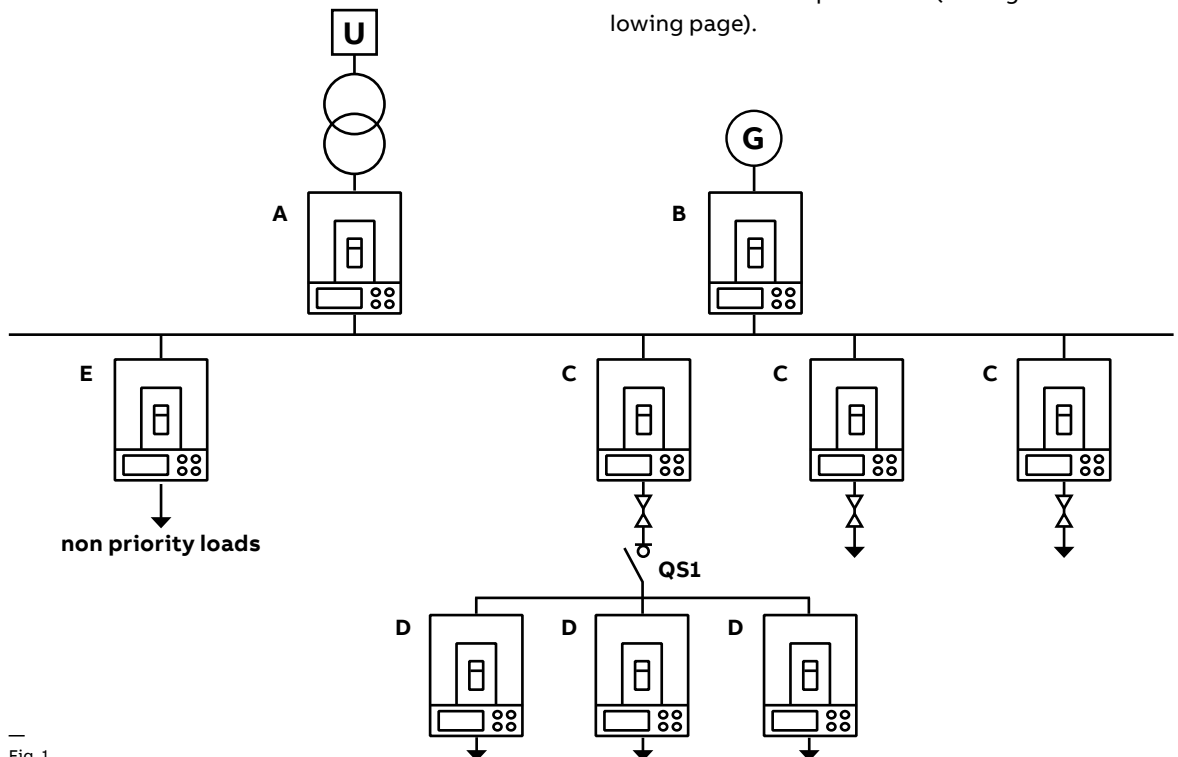

Fig. 1

Adaptive Protections

With the adaptive protections, when there is an utility outage, circuit-breaker A opens and B closes in order to achieve an islanded condition. In order to still guarantee selectivity, another set of protection settings is required. Adding Tmax XT adaptive protections to the circuit-breaker C1 ensures this behaviour. The second protection setting is optimized for the characteristics of the local generator ensuring the incoming supply. Additionally, selective coordination with the load side switching devices is also guaranteed.

With reference to Fig. 1:

- Circuit-breaker A is open
- Circuit-breaker B is closed
- Circuit-breakers at position C are closed and the protection thresholds move automatically to “Set B”
- Circuit-breakers at position D are closed
- Circuit-breaker E is open
- Molded case switch QS1 is closed
- Non-priority loads can be disconnected using another functionality of the Tmax XT units (see next paragraph).

Fig. 3 shows how it is possible to switch to a set of parameters which guarantees selective coordination between circuit-breakers C and B by means of the Adaptive Protection function embedded in the trip unit of the C circuit-breakers.

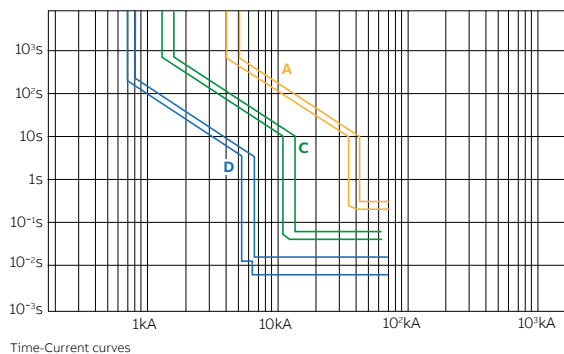

Fig. 2 - Protection thresholds during on-grid operation

Benefits

Thanks to the Tmax XT it is possible to have two sets of settings implemented in a single device. As a result, the following benefits are guaranteed:

- Overcurrent protection and selectivity 100% guaranteed both in grid-connected and islanded conditions.
- Service continuity is guaranteed by just adding a single unit to the switchboard in every plant condition.
- Ease of use, thanks to the Ekip Connect software which allows an immediate and intuitive commissioning phase.

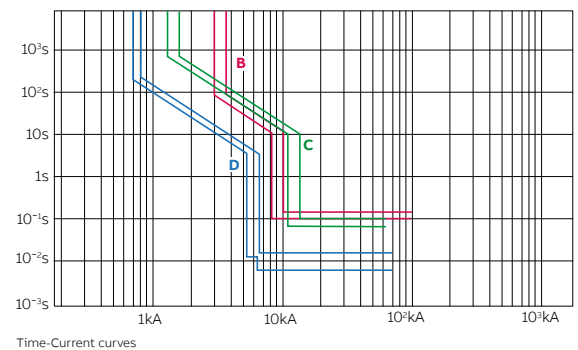

Fig. 3 - Protection thresholds during islanded operation

Load Shedding

The Tmax XT has many load shedding algorithms to avoid power unbalance in low voltage plants and to reduce stress for all the components.

Purpose

The Tmax XT embeds patented functions based on load shedding which reduce the microgrid stress in all situations. Typically, it is the main protection trip unit of the low voltage microgrid located at the interface point with the medium voltage grid that is able to control the plant in all circumstances.

A microgrid under islanding conditions

After the Tmax XT circuit-breaker opens, due to the interface protection system intervention or external command, the microgrid should seamlessly pass from an on-grid to off-grid state. When it operates in a stand-alone capacity, the power absorption from the main grid ceases, so that the microgrid loads remain supplied by local generation, such as from a diesel GenSet or an energy storage system. This microgrid generation can be always active or started by Automatic Transfer Switching (ATS) logic after the disconnection from the main grid, depending on the plant configuration. During the islanding transition, it is very important to avoid a frequency drop, otherwise the generation protections could trip and jeopardize the microgrid stability with a consequently long downtime. The Tmax XT employs current and voltage measurements, and integrates two different fast load shedding types of logic to reduce this blackout risk. This protects the microgrid during intentional or unintentional islanding operations:

- The Basic Load Shedding algorithm is a simple form of logic able to recognize the microgrid disconnection event and shed a group of not priority loads thus ensuring a fast time response and power balance.
- The Adaptive Load Shedding algorithm is an advanced algorithm available with the Tmax XT as an enhancement of the basic version. The intelligent software embedded in the unit sheds the non-priority loads very quickly according to the microgrid power consumption and frequency measurements. Moreover, the software has a dedicated configuration for backup generation related to Automatic Transfer Switching (ATS) and the software itself is even able to estimate the energy produced by a solar plant based on the plant geography settings.

A microgrid in grid-connected conditions

Under normal circumstances, the microgrid is generally connected to the utility in order to inject/absorb surplus or shortfalls of energy. In this situation, with the Tmax XT as the main circuit-breaker installed immediately downstream of the MV/LV transformer in a closed status, power overload should be avoided so as not to excessively stress the plant elements. In order to do this, the circuit-breaker embeds a patented load shedding algorithm:

- The Predictive Load Shedding algorithm is a slow disconnection of loads based on the limit of the average power flow towards the microgrid according to the transformer size designed for the power peak profile.

All three Load Shedding versions are available on the Tmax XT platform for both microgrid situations, sharing some information about the loads under control in the plant.

Application examples

- **Grid-connected plants with running GenSets**
These contribute to self-consumption together with potential renewable sources and support the load power supply in emergency conditions. This is the case for hybrid photovoltaic diesel remote communities connected to weak distribution grids where there are a lot of daily faults, or facilities located in geographical areas where there are frequent environmental events, for example hurricanes or earthquakes.
- **Grid-connected plants with back-up GenSets**
These are started up after main generator transfer switching logics and require high reliability. For example, hospitals, banks or data centers.

Load Shedding

Benefits

Thanks to Tmax XT with the embedded Load Shedding innovations, the following benefits are guaranteed:

Service continuity

When a plant remains disconnected from the main grid, even if local generation is present, there is a significant stress that may imply that the generators fail with a consequent blackout.

Load Shedding logic embedded in the Tmax XT reduces the frequency drop that usually makes the local generation protection trip, maintaining a live plant.

Space saving

- No other programmable logic controllers (PLCs) are needed as the Tmax XT has embedded intelligence for the load shedding logics, taking advantage of the current and voltage sensors for electrical parameter measurements.
- In addition, static converters for low voltage photovoltaic production typically have anti-islanding protection: this implies another power deficit to be added to the main grid contribution during the microgrid islanding. The Tmax XT estimates solar production without additional sensors.

- The Load Shedding algorithm is suitable with ATS architectures like Main-Bus Tie-Gen used to distinguish priority and non-priority loads.

Where feasible, a BusTie switching device is no longer required and this means:

- Significant space and material savings of up to 50% in the power distribution switchgear for panel builders.
- The Load Shedding algorithm is self-tuned with specific power unbalance identification and dynamically chooses the controllable loads to be shed, reducing constraints for consultants during plant design.
- The ATS unit only manages two sources, without interlock, logic programming or wiring connections for the third circuit-breaker with less time required for installation.

Ease of use

Load shedding logic is generally set using top engineering skills and customization efforts with devices as programmable logic controllers.

The Tmax XT guarantees easy installation thanks to predefined templates and the user-friendly graphic interface in the software commissioning tool.

Typical Load Shedding application

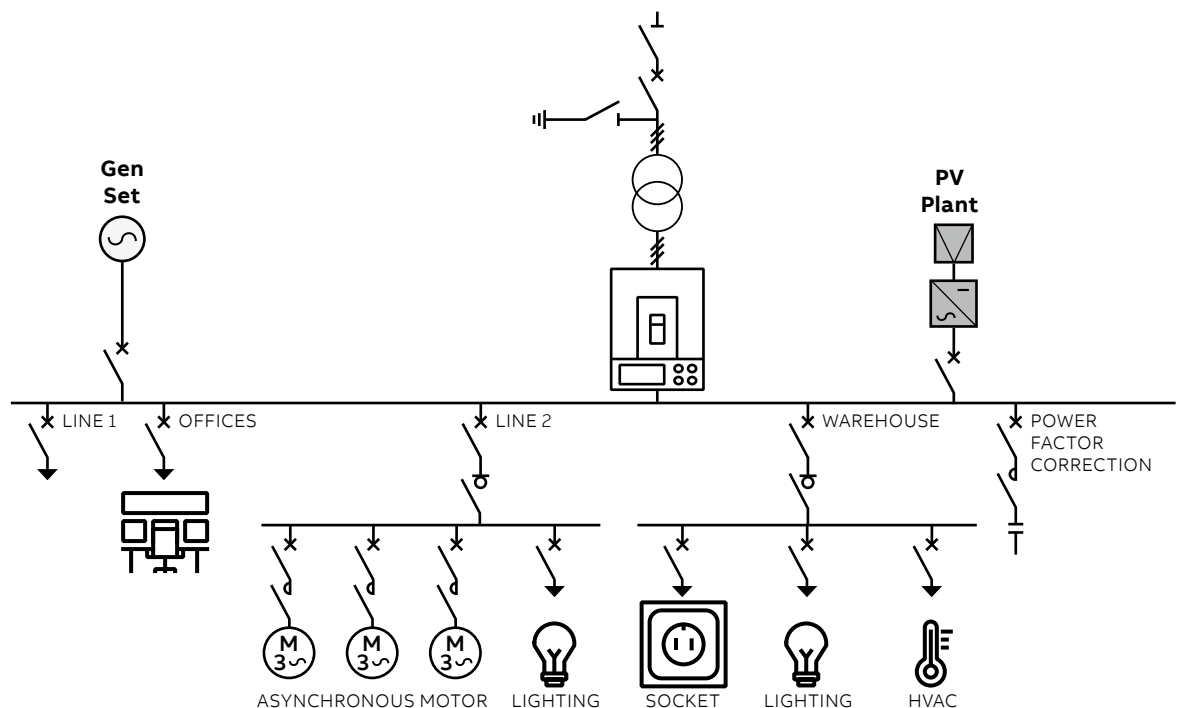

Automatic Transfer Switch

The Tmax XT is ready for transfer switching applications reducing time

The ATS solution

ABB Automatic Transfer Switch system (ATS) takes advantage of the new capabilities provided by the new Ekip Connect 3 Software with intelligent digital units such as the Tmax XT to deliver versatile and reliable solutions.

Application example

Automatic transfer switch systems are common in all applications where service continuity is essential and where there are multi source supplies.

The main applications are:

- Power supplies of UPS groups
- Oil & Gas
- Operating theatres and primary hospital services
- Emergency power supplies for civil buildings, hotels and airports
- Data banks and telecommunication systems
- Power supply of industrial line for continuous processes.

An ATS can be used also whenever a portion of a grid with local generation, known as a microgrid, can be disconnected from the main grid.

ATS application example

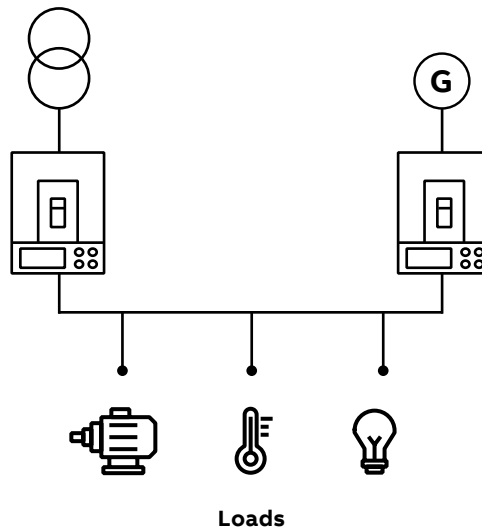

Automatic Transfer Switch

The ATS is a high-performing energy automation system, easy to install



Benefits

Ready-to-go programming

Estimated time and cost savings on the ATS engineering on a low voltage project: 95%.

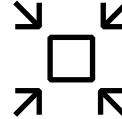

Tmax XT compactness

Space saving on the power switchboard: up to 30%.



Simplify the connections

Estimated time and cost savings on cabling and commissioning of the power switchboard: 50%.



Top rate reliability

With watchdog functions and fewer installed components.

Synchro Reclosing

The Tmax XT is able to synchronize voltage waveforms from different power sources.

Purpose

Thanks to its advanced electronics, the Tmax XT is a smart unit which is able to island the microgrid from disturbances such as in the presence of faults or power quality events and reconnect it to the distribution network once perfect conditions are guaranteed.

This feature is the Synchro Reclosing function. This consists of synchronization support of the microgrid reconnection operation or generator parallel procedures as described by ANSI protection Code 25A, with additional automatic reclosing capabilities based on synchronism status detection.

Using the Ekip Synchrocheck cartridge module, the Tmax XT monitors the voltage amplitude, frequency and phase displacement and implements simple logics to adapt the microgrid voltage and frequency to the main grid. This regulation is based on up and down signals sent to the local generator controllers and is implemented via the Ekip Signaling contacts. The circuit-breaker automatically recloses when it understands that the synchronism has been achieved using the Ekip Synchrocheck and the integrated closing coil.

Sometimes this operation can be very critical because the current during the transient of the reconnection must not reach values that can potentially cause the microgrid shut down. With the aim of avoiding complex analyses and customizations, the Ekip Connect 3.0 commissioning tool completes the Synchro Reclosing functionality and recommends the appropriate settings according to the plant configuration.

Application examples

The Synchro Reclosing function is useful in the following plant-engineering situations:

- During the reconnection of the microgrid to the main grid, speeding up a parallel procedure between two systems with different steady states. This scenario comes after an islanding microgrid operation.
- When there is a closed transition of an automatic transfer switch, the main grid should be connected to the same busbar with backup microgrid generation in order to guarantee continuous load operation, with or without a bus-tie switching device.
- In addition to microgrid cases, it is possible to adopt this solution also for single GenSet parallel operations.

Synchro Reclosing application example

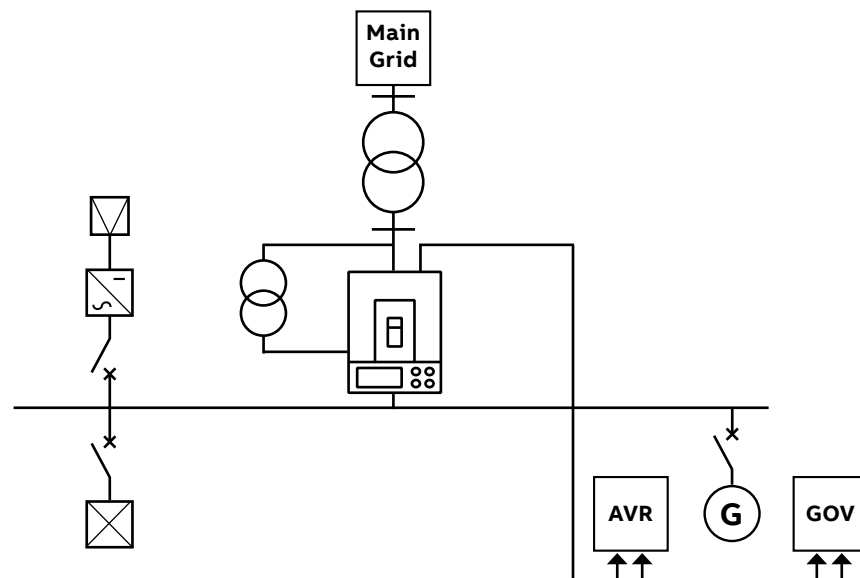

Synchro Reclosing

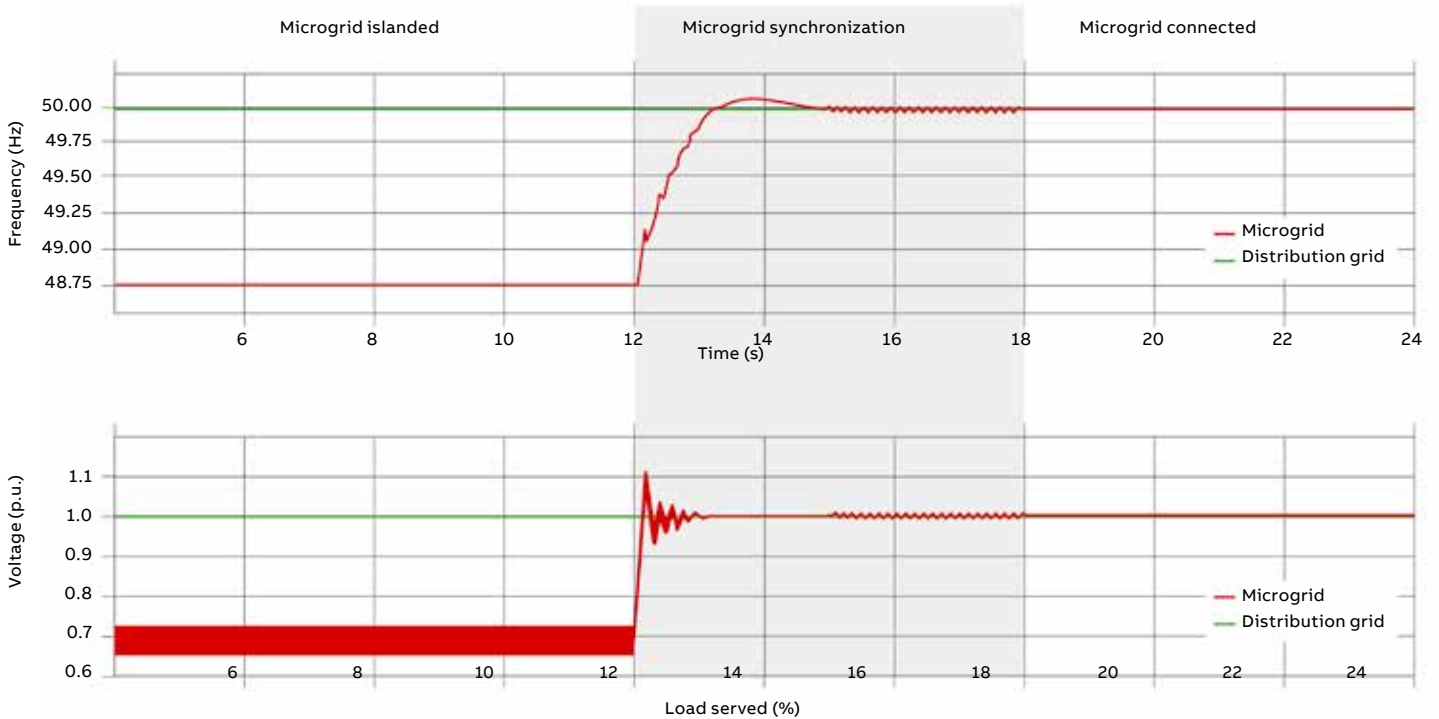

Benefits

Thanks to the Tmax XT with its embedded Synchro Reclosing function, the following benefits are guaranteed:

Space saving

- Components reduction with no external synchronizer and less voltage transformers required compared to traditional approaches.
- Increased reliability and time saving during the installation with less cabling and related installation complexity.

Ease of use

- The logic is embedded in the trip unit so there is no need for programming or engineering skills.
- Simplified configuration with Ekip Connect software offers predefined configuration templates with suggested values and a clear user interface for customization.

Accessories

Execution and installation

- 7/4 Fixed, plug-in and withdrawable version
- 7/6 Conversion kits
- 7/6 Connectors for electrical accessories
- 7/9 Bracket for fixing on DIN-rail
- 7/9 Motorizable version

Power connection

- 7/10 Connection terminals

Signaling

- 7/18 Auxiliary contacts - AUX
- 7/19 Auxiliary Position Contacts - AUP
- 7/26 Auxiliary Position Contacts - AUP
- 7/28 Early Auxiliary Contacts - AUE
- 7/29 Ready to close signaling contacts - RTC
- 7/29 Contact signaling loaded springs - S33 M/2
- 7/29 Mechanical signaling of tripping the protection nit - TU Reset

Operating mechanism

- 7/30 Rotary handle operating mechanism
- 7/31 Telescopic Rod - RHE_ST
- 7/32 Front for the lever operating mechanism
- 7/32 Toggle extension

Remote control

- 7/33 Service releases
- 7/38 Resetting from remote - YR
- 7/38 Opening and closing release test unit - YO/YC Test Unit
- 7/39 Electronic time-delay device for undervoltage release - UVD
- 7/39 Motor Operators
 - 7/39 Direct action motor operator - MOD
 - 7/41 Stored energy motor operators - MOE and MOE-E (XT2-XT4)
 - 7/42 Stored energy motor operators - MOE and MOE-E (XT5-XT6)
 - 7/44 Motor - M

Safety and protection

- 7/45 Terminal covers
- 7/45 Phase separators
- 7/45 Sealable screws for terminal covers
- 7/46 Padlocks and key locks
- 7/49 IP Protection Kit
 - 7/49 IP54 Protection for transmitted rotary handle (RHE)
 - 7/49 IP54 Protection flange for direct rotary handle (RHD)
 - 7/49 IP54 Protection flange for MOE and XT7 M
- 7/50 Protection device for opening and closing pushbuttons - PBC
- 7/50 Mechanical operation counter - MOC
- 7/50 Flanges

Interlocks and switching devices

- 7/51** Rear mechanical interlock
- 7/52** Cables interlocks
- 7/53** Automatic network-generator transfer unit ATS021-ATS022

Residual current protection

- 7/55** Residual current release

7/65 Compatibility of accessories

Execution and installation

Fixed, plug-in and withdrawable version

SACE Tmax XT circuit-breakers are available in the following versions:



Fixed circuit-breaker



Plug-in circuit-breaker



Withdrawable circuit-breaker

- **FIXED**

Fixed circuit-breakers consist of a current-interrupting part connected to the trip unit, to be installed on the back plate of the cubicle or on a DIN-rail;

- **PLUG-IN**

Plug-in circuit-breakers consist of a fixed part that must be installed on the back plate of the cubicle, and of a moving part, obtained from the fixed circuit-breaker plus the relative kit that converts it from the fixed version into the moving part of the plug-in version;

- **WITHDRAWABLE**

Withdrawable circuit-breakers consist of a fixed part that must be installed on the back plate of the cubicle equipped with side runners to allow the moving part to be easily racked -in and -out. Such a solution is obtained from the fixed circuit-breaker plus the relative kit that converts it from the fixed version to a withdrawable moving part. To obtain the withdrawable version, a front accessory to be applied to the front of the circuit-breaker must be ordered so as to maintain the IP40 degree of protection over the entire disconnection run of the circuit-breaker (except for the XT7). This mandatory accessory is a standard supply for circuit-breakers fitted with accessories in the factory.

If the plug-in circuit-breaker is fitted with electrical accessories, the appropriate connectors for disconnection of the relative auxiliary circuits must also be ordered. For the withdrawable version there are dedicated accessories, fitted with connectors, which allow automatic disconnection in the case of racking-out. Starting from the fixed version, the SACE Tmax XT circuit-breakers can be easily converted into plug-in and withdrawable versions by using the relative conversion kits.

The moving parts can always be obtained for the required version, fully pre-engineered from the factory, by ordering the fixed circuit-breaker and the conversion kit at the same time.

	Version		
	Fixed	Plug-in	Withdrawable
XT1	■	■	-
XT2	■	■	■
XT3	■	■	-
XT4	■	■	■
XT5	■	■	■
XT6	■	-	■
XT7	■	-	■
XT7 M	■	-	■

The fixed version, which is connected directly to the power system through the circuit-breaker terminals, is recommended for applications in which the need for space can be satisfied by compact products without affecting the performance.

The plug-in version is recommended for applications for which service continuity is a fundamental requirement: the replacement of the moving part with a new one does not require any intervention on the power supply connections.

The withdrawable version, in addition to the advantages of the plug-in version, offers three different positions:

- connected: power and auxiliary circuits are connected
- test: power circuits are disconnected, while auxiliary circuits are connected (only for XT5, XT6 and XT7)
- disconnected: both power and auxiliary circuits are disconnected.

Fixed part of plug-in and withdrawable versions

The fixed part of the plug-in/withdrawable versions is available with front terminals (EF), with horizontal rear terminals (HR) or with vertical rear terminals (VR). The terminals are factory mounted in the horizontal position if the code is shared between HR and VR. In this case, it is possible to easily rotate the terminals into the vertical position. For the XT5 and XT6 circuit-breakers, the fixed part can be fully pre-engineered in the factory with the required combination of terminals, by ordering the dedicated configurable fixed part code and the terminals at the same time.

These fixed parts can be equipped with the same terminals, terminal-covers and phase separator kits used for the fixed circuit-breakers, using the proper adapter (see the "Power connection" section). For the Tmax XT1, XT2, XT3, XT4 and XT5, the fixed part of a plug-in/withdrawable circuit-breaker can be installed at two different distances from the back of the panel, according to the picture below. For the XT1, XT2, XT3 and XT4, installation at 1.96 in is only compulsory in the case where rear horizontal or vertical terminals (HR/VR) are used.

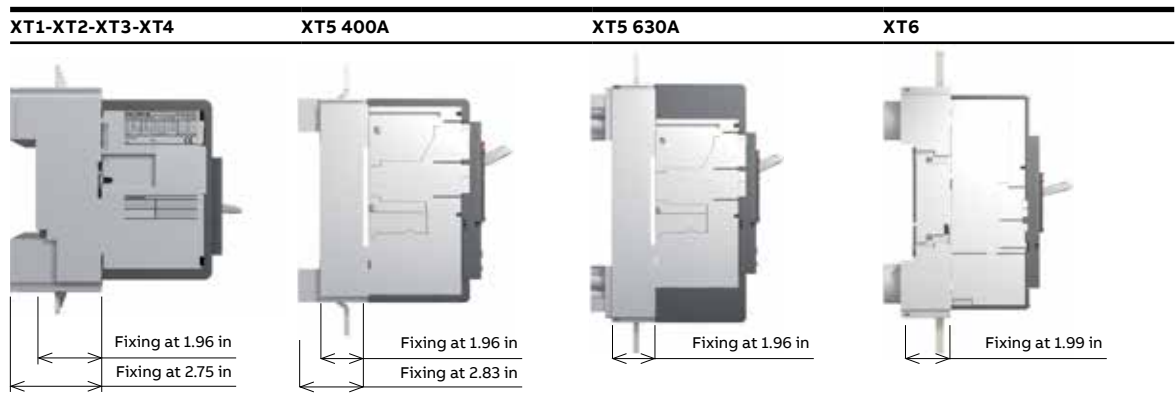

Execution and installation

Conversion kits

The following conversion kits can be ordered for the different versions. This is applicable to the whole Tmax XT family, up to Tmax XT6.



— Conversion kit for converting a fixed circuit-breaker into the moving part of a plug-in circuit-breaker

- **Kit for converting a fixed circuit-breaker into the moving part of plug-in/withdrawable versions**

The conversion kit converts a fixed circuit-breaker into a moving part of the plug-in/withdrawable versions. When withdrawable versions are required, it is essential to order an accessory for the front of the circuit-breaker to maintain the IP40 degree of protection along the entire insulation run. This accessory is made of the following options:

- front for the lever operating mechanism (FLD);
- motor operator (MOE);
- direct or transmitted rotary handle operating mechanisms (RHD or RHE).

In the case where no accessory to be applied onto the front is indicated, the front for the lever operating mechanism (FLD) is automatically included in the order.



— Conversion kit for converting a fixed circuit-breaker into the moving part of a withdrawable circuit-breaker

- **Kit for converting a fixed part of a plug-in version into the fixed part of withdrawable versions**

The kit comprises:

- a guide for transforming the fixed part of the plug-in circuit-breaker into a fixed part of a withdrawable circuit-breaker;
- a racking-out lever that allows the moving part to be inserted and withdrawn. The mechanism allows the circuit-breaker to be set to the disconnected position (with the power and auxiliary circuits disconnected) with the compartment door closed, which is an advantage for operator safety. The rotary handle can only be inserted when the circuit-breaker is open. Once it has been removed or withdrawn, the circuit-breaker can be set to the open/closed position;
- a flange for the compartment door, which replaces the one supplied with the fixed version of the circuit-breaker.



— Conversion kit for converting a fixed part of plug-in version into the fixed part of a withdrawable version

- **Kit for converting a fixed circuit-breaker into the plug-in version for RC Sel residual current devices for XT2-XT4-XT5**

The RC Sel 4-pole residual current devices for the XT2, XT4 and XT5 can be converted from fixed versions to plug-in versions using the special kit.

- **Kit for converting plug-in circuit-breakers into withdrawable versions for RC Sel residual current devices for the XT2-XT4-XT5**

The RC Sel 4-pole residual current devices for the XT2, XT4 and XT5 can be converted from the plug-in version to the withdrawable version using a special kit, which includes a component to apply to the front of the residual current device so as to allow it to be withdrawn when the panel door is closed. This kit can also be assembled on fixed circuit-breakers equipped with a front for a lever operating mechanism or the direct rotary handle, thus allowing the use of residual current devices.

In the plug-in to withdrawable conversion kit, there are also PIN connectors to be applied onto the right side of the circuit-breaker to facilitate disconnection of the auxiliary circuits connected to the residual current device.

For the XT1, XT2, XT3 and XT4, this kit also contains the opening solenoid of the residual current device dedicated to the withdrawable version, which is fitted with a connector for the fixed part and the moving part.

For the SACE Tmax XT7 and XT7 M there is a dedicated conversion kit to transform a fixed circuit-breaker into the moving part of the withdrawable version. No additional accessory is required.

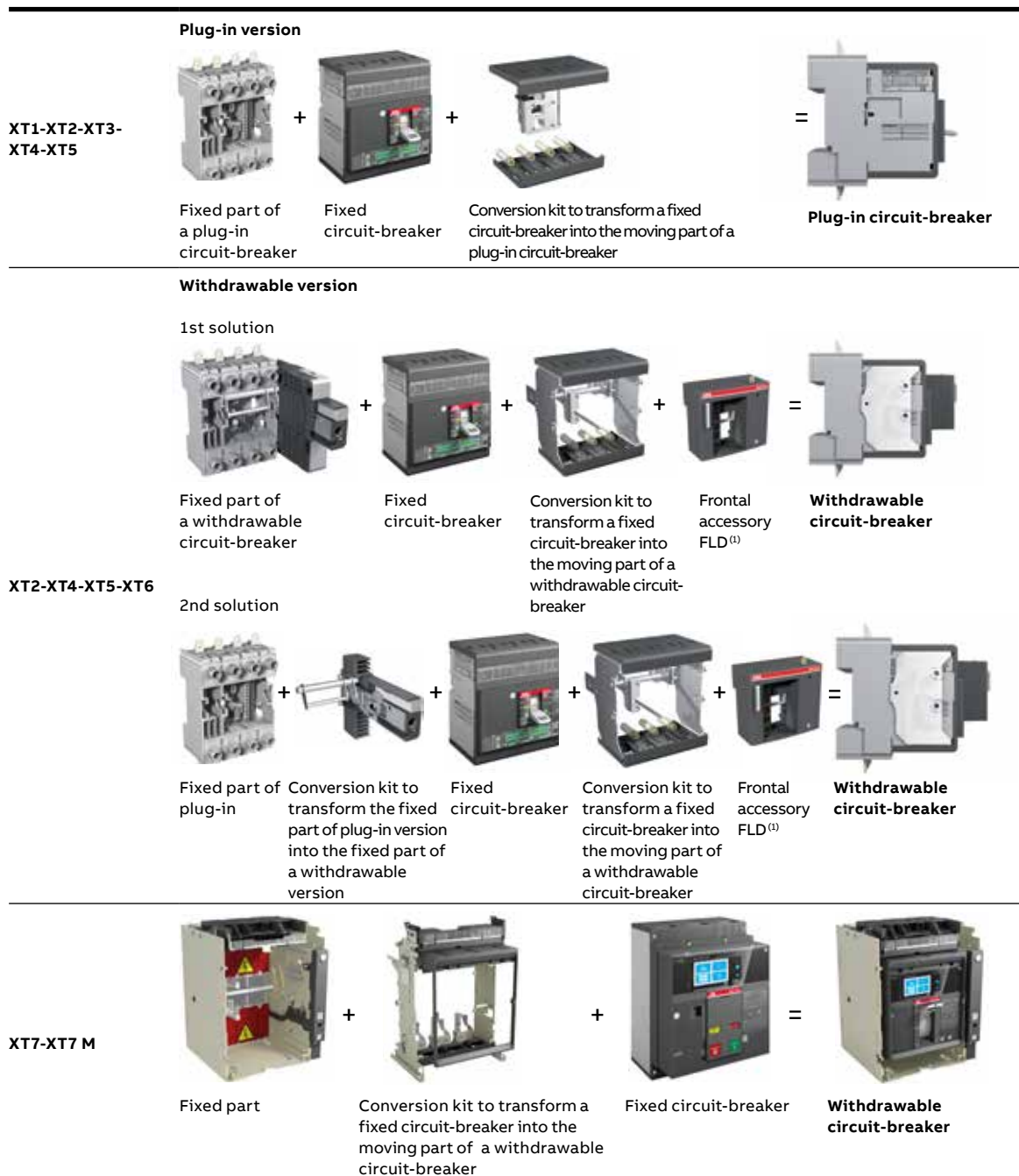

(1) Frontal accessory mandatory. If not specified in the order, the FLD is supplied automatically

Execution and installation

Connectors for electrical accessories

Plug-in circuit-breaker

In the plug-in version of the SACE Tmax XT circuit-breakers, the auxiliary circuits can be disconnected by means of two different types of adapter:

- a plug and socket to be fixed on the bottom of the panel: for the XT1, XT2, XT3, XT4 and XT5;
- a plug and socket installed on the rear of the circuit-breaker and in the fixed part of the plug-in devices: for the XT2, XT4 and XT5.

Plug and socket on the back of the panel

To make it easier to connect/disconnect the auxiliary circuits, wired electrical accessories can be connected to one or more plug and socket connectors on the back of the panel.

3, 6, 9 and 15 PIN connectors are available. The cables connect/disconnect the auxiliary circuits in a fast and simple way without the aid of any dedicated tools.

Consider the number of cables of each electrical accessory when calculating the number of connectors required.



Plug and socket adapters on the back of the panel

Number of cables	XT1-XT2-XT3-XT4 accessories	XT5-XT6 accessories
2	SOR, UVR / External Neutral Ekip Dip trip units / PTC for Ekip M-LRIU / Ekip Com Modbus RTU / Ekip Com Modbus TCP STA	YO, YU / Ekip Com Modbus RTU / Ekip Com Modbus TCP STA
3	RC Coil / 1 AUX	1 AUX
4	24V DC/Internal bus cable / Ekip Com Modbus RTU STA / AUE	24V DC/Internal bus cable / Ekip Signaling 1K / Ekip Com Modbus RTU STA / Ekip Maintenance Module / AUE
5	MOE-E / Selectivity cable	Selectivity cable
6	Ekip Com ⁽¹⁾ / Residual current device	Residual current device, MOE-E
7	MOE (with AUX-MO) / MOD (with AUX-MO)	-
8	-	MOE (with AUX-MO)

(1) Ekip Com for Ekip LSI, LSIG and M-LRIU

Plug and socket adapters on the rear of the circuit-breaker and inside the fixed part

For the plug-in versions of the XT2, XT4 and XT5 circuit-breakers, the auxiliary circuits can be automatically disconnected by means of an adapter installed on the rear of the circuit-breaker and inside the fixed part of plug-in versions.

The 12 PIN connector can be used only with accessories functioning at a voltage lower than 250V AC/DC. The cables connect/disconnect the auxiliary circuits in a fast and simple way without the aid of any dedicated tools. Wiring is to be carried out by the Customer.



Plug and socket adapter placed on the back of the moving part



Plug and socket adapter in the fixed part

Circuit-breaker	Number of plugs and sockets installed on the rear of the circuit-breaker and inside the fixed part
XT2-XT4	1
XT5	2



—
Cabling of withdrawable versions

Withdrawable circuit-breaker

When withdrawable circuit-breakers are used, the codes of the electrical accessories specifically designed for this version must be ordered. These dedicated codes include the wired electrical accessory with a connector for the moving part and for the fixed part to be inserted on the side of the fixed part. If the MOE motor operator is ordered, connectors for the fixed part and moving part are always supplied since there is no dedicated code for the withdrawable version. This type of connection allows the auxiliary circuits to be disconnected automatically when the circuit-breaker is withdrawn from the fixed part. If cabling of the fixed part is required before wiring the moving part, the fixed part mounting connectors can be ordered as spare parts.

XT7 and XT7 M

Two different areas for the auxiliary connection terminal boxes can be clearly identified on the top of the XT7 and XT7 M circuit-breakers:

- The terminal area housing the terminals for wiring the auxiliary connections. The terminals can be wired first and then installed in the circuit-breaker terminal box, thereby facilitating cable connection for the operator;
- The cartridge modules area, housing the Ekip modules. These are installed directly on the upper part of the circuit-breaker without removing the Ekip electronic trip unit, thereby minimizing the time required for the installation and commissioning of accessories.

These areas are the same also in case of withdrawable versions.

Bracket for fixing on DIN-rail

This is a support designed to be installed on the back of the circuit-breakers to simplify assembly on standardized DIN EN 50022 rails.

The following circuit-breakers can be installed on the DIN EN 50022 rail:

- XT1, XT2, XT3 and XT4 circuit-breakers in the fixed 3-pole or 4-pole versions;
- XT1, XT3 circuit-breakers equipped with RC Sel 200; RC Inst, RC Sel for XT1 and XT3 residual current releases.



—
Bracket for fixing on DIN-rail

Motorizable version

The XT7 M can be equipped with a spring charging motor. To allow complete remote control with the XT7 M, the circuit-breaker must be fitted with:

- A shunt opening release (YO)
- A shunt closing release (YC)
- A spring charging motor (M)



—
Tmax XT7 M

Power connection

Power connection		XT1	XT2	XT3	XT4	XT5	XT6	XT7	XT7 M
Terminals for circuit-breaker	F - Front	■	■	■	■	■	■	■	■
	EF - Front extended	■	■	■	■	■	■	■	■
	ES - Front extended spread ⁽¹⁾	■	■	■	■	■	■	■	■
	FCCu - Front for copper cables ⁽¹⁾	■	■	■	■	-	-	-	-
	FCCuAl - Front for copper/aluminium cables ⁽¹⁾	■	■	■	■	■	■	■	■
	FB - Flexible busbars ⁽¹⁾	■	■	■	■	-	-	-	-
	MC - Multi-cable ⁽¹⁾	■	■	■	■	-	-	-	-
	R - Rear orientated	■	■	■	■	■	■	-	-
HR/VR - Rear orientable terminal	-	-	-	-	-	-	■	■	
Terminals for fixed part	EF - Extended front for fixed part	■	■	■	■	■	■	■	■
	HR/VR – Horizontal/vertical rear for fixed part ⁽²⁾	■	■	■	■	■	■	■	■
	ES - Extended spread front for fixed part	-	-	-	-	-	-	■	■
	SHR - horizontal rear spread terminals for fixed part	-	-	-	-	-	-	■	■
	FCCuAl – Front copper/aluminium cables for fixed part	-	-	-	-	-	-	■	■
Terminals for Residual current Device	HR for RC - for residual current release	■	-	■	-	-	-	-	-

(1) From XT1 to XT6, the same terminals of fixed circuit-breakers can be mounted on the fixed part if the adapter is installed.

(2) For the XT5 600A fixed part, the HR and VR have different codes

Connection terminals

Connection terminals allow the circuit-breaker to be connected to the system in the way most suitable for the installation requirements. They consist of:

- front terminals: for connecting cables or busbars directly from the front of the circuit-breaker;
- rear terminals: for installing circuit-breakers in segregated panels with rear access.

Where possible, the terminals have a laser marking on the surface indicating the tightening torques for the correct insulation of cables and bars.

Fixed version

The standard fixed version of the SACE Tmax XT circuit-breakers are supplied with front terminals (F). However, they can be fitted with the following types of terminals as accessories thanks to the special kits:

- extended front (EF);
- extended spread front (ES);
- front for copper/aluminium cables (FCCuAl). A pitch adapter must be applied to the terminal zone of the circuit-breaker to ensure that copper and aluminium cables can be connected to all the circuit-breakers. The pitch adapter is automatically supplied when it is necessary;
- front for copper cables (FCCu);
- for flexible busbars (FB);
- multicable (MC);
- rear oriented (R).



—
Fixed part adapters

Plug-in and withdrawable versions

The fixed part of the plug-in and withdrawable versions of the XT1, XT2, XT3 and XT4 circuit-breakers are normally supplied with extended front terminals (EF) or horizontal/vertical rear terminals (HR/VR).

The terminals are factory-mounted in the horizontal position. If needed, the customer can easily rotate the terminals into the vertical position. A fixed part with front terminals (EF) can be converted into a fixed part with rear terminals (HR/VR) by ordering the appropriate terminal kit.

The fixed part of the plug-in and withdrawable versions of the XT5 and XT6 circuit-breakers can be accessorized directly when ordering with extended front terminals (EF) or horizontal/vertical rear terminals (HR/VR), that can be different from the top and bottom terminals.

The terminals are factory-mounted in the horizontal position. If needed, the customer can easily rotate the terminals into the vertical position. For the XT5 600A fixed part, the HR and VR terminals are different and not interchangeable.

The fixed parts can also be fitted with the same types of terminals available on the fixed circuit-breaker after an adapter has been installed on the terminal area of the fixed part itself. Consequently, the following types of connection terminals are also available for the fixed part:

- extended spread front (ES);
- for copper-aluminium cables (FCCuAl);
- for copper cables (FCCu);
- for flexible busbars (FB);
- multi-cable (MC).

The adapter reproduces the terminal area of the fixed circuit-breaker. This means that the fixed parts can also be equipped with the same terminal covers and phase separators as those used for fixed circuit-breakers. In order to mount terminals on the adapter, the front terminals "F" kit provided with the circuit-breaker is needed.

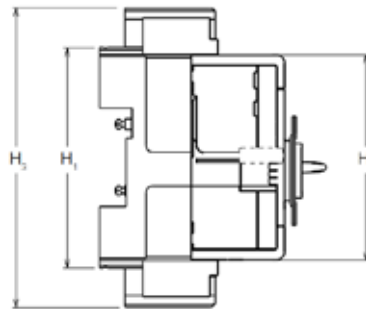

Fixed part adapter

Circuit breakers	"H1 fixed part [mm/in]"	"H2 circuit breaker [mm/in]"	"H3 fixed part with two adapters [mm/in]"
XT1	146/5.75	134/5.28	181/7.13
XT2	153/6.02	134/5.28	188/7.40
XT3	166/6.54	154/6.06	225/8.86
XT4	182/7.17	164/1.46	228/8.98
XT5 400A	209/8.23	209/8.23	283/11.14
XT5 600A	273/10.75	273/10.75	347/13.66
XT6	295/11.61	273/10.75	408/16.06

For the XT7 and XT7 M, dedicated terminals for fixed part must be ordered.

Power connection

Terminals for circuit-breaker

Front terminals - F



Front terminal - F



F terminal with cable lug



F terminal with busbar

CB	Vers.	Busbars dimensions [mm/in]					Cables terminals [mm/in]		Tightening [Nm/lb-in]	Terminal covers height [mm/in]				Phase Separators Height [mm/in]				
		W min	W max	H	Ø	D min	D max	W		Ø	2/ 0.08	50/ 1.97	60/ 2.36	68/ 2.68	25/ 0.98	100/ 3.94	200/ 7.87	
XT1	F	13/ 0.512	16/ 0.63	7.5/ 0.295	6.5/ 0.256	3.5/ 0.138	5/ 0.197	16/ 0.63	6.5/ 0.256	M6	6/ 53.1	-	R	-	-	S _{CB}	R	R
XT2	F	13/ 0.512	20/ 0.787	7.5/ 0.295	6.5/ 0.256	2.5/ 0.098	5/ 0.197	20/ 0.787	6.5/ 0.256	M6	6/ 53.1	-	R	-	-	S _{CB}	R	R
XT3	F	17/ 0.669	24/ 0.945	9.5/ 0.374	8.5/ 0.335	5/ 0.197	8/ 0.315	24/ 0.945	8.5/ 0.335	M8	8/ 70.8	-	-	R	-	S _{CB}	R	R
XT4	F	17/ 0.669	25/ 0.984	10/ 0.394	8.5/ 0.335	5/ 0.197	8/ 0.315	25/ 0.984	8.5/ 0.335	M8	8/ 70.8	-	-	R	-	S _{CB}	R	R
XT5	F	25/ 0.984	35/ 1.378	12/ 0.472	10.5/ 0.413	5/ 0.197	10/ 0.394	35/ 1.378	10.5/ 0.413	M10	28/ 247.82	R	-	R	-	S _{CB} ⁽¹⁾	R	R
XT6	F	40/ 1.575	50/ 1.969	12/ 0.472	2x7/ 0.276	5/ 0.197	5/ 0.197	50/ 1.969	2x7/ 0.276	M6	9/ 79.65	R	-	R	-	-	R	R
XT7 -	F	40/ 1.575	50/ 1.969	20/ 0.787	2x11/ 0.433	1x10/ 0.394	2x10/ 0.394	2x24/ 0.945	2x11/ 0.433	M10	18/ 159.31	R	-	-	R	-	R	R
XT7M																		

(1) Phase barriers 25 mm are mandatory according indications on instructions sheet

Extended front terminals - EF



Front extended terminal - F



EF terminal with cable lug



EF terminal with busbar

CB	Vers.	Busbars dimensions MAX [mm/in]			Cables terminals [mm/in]		Tightening [Nm/lb-in]		Terminal covers height [mm/in]				Phase Separators Height [mm/in]					
		W	D	Ø	W	Ø	Terminal/ CB	Cable or busbar / Terminal	2/ 0.08	50/ 1.97	60/ 2.36	68/ 2.68	25/ 0.98	100/ 3.94	200/ 7.87			
XT1	F	20/ 0.787	4/ 0.157	8.5/ 0.335	20/ 0.787	8.5/ 0.335	M6	6/ 53.1	M8	9/ 79.7	-	R	-	-	-	S _T	R	
XT2	F	20/ 0.787	4/ 0.157	8.5/ 0.335	20/ 0.787	8.5/ 0.335	M6	6/ 53.1	M8	9/ 79.7	-	S _T	-	-	-	S _T	R	
XT3	F	20/ 0.787	6/ 0.236	10/ 0.394	20/ 0.787	10/ 0.394	M8	8/ 70.8	M10	18/ 159.3	-	-	R	-	-	S _T	R	
XT4	F	20/ 0.787	10/ 0.394	10/ 0.394	20/ 0.787	10/ 0.394	M8	8/ 70.8	M10	18/ 159.3	-	-	S _T	-	-	S _T	R	
XT5	F	32.5/ 1.28	10/ 0.394	11/ 0.433	32.5/ 1.28	11/ 0.433	M10	28/ 247.82	M10	18/ 159.3	-	-	R	-	-	S _T	R	
XT6	F	50/ 1.969	5/ 0.197	14/ 0.551	50/ 1.969	14/ 0.551	M6	9/ 79.97	M12	30/ 265.52	-	-	-	-	-	S _T	R	
XT7 -	F	50/ 1.969	2x10/ 0.394	4x11/ 0.433	4x20/ 0.787	11/ 0.433	M10	18/ 159.93	M10	40/ 354.03	-	-	-	R	-	S _T	R	
XT7M																		

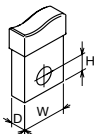

W Width	P Plug-in	S _{CB} Supplied as standard with circuit-breaker, not available in the loose terminals kit
H Hole height	W Withdrawable	S _T Supplied as standard with the terminals kit
D Depth	Ø Diameter	
F Fixed	R On Request	



Front extended spread terminal - F



ES terminal with cable lug



ES terminal with busbar



FCCu terminal



FCCu terminal with cable



FCCu terminal with busbar

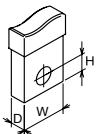

Front extended spread terminals - ES

CB	Vers.	Busbars dimensions MAX [mm/in]			Cables terminals [mm/in]		Tightening [Nm/lb-in]			Extended spread terminal covers		Phase separators height [mm/in]		
		W	D	Ø	W	Ø	Terminal/CB	Cable or busbar / Terminal			25/ 0.98	100/ 3.94	200/ 7.87	
XT1	F-P	25/ 0.984	4/ 0.157	8.5/ 0.335	25/ 0.984	8.5/ 0.335	M6	6/ 53.1	M8	9/ 79.7	-	-	-	S _T
XT2	F-P-W	30/ 1.181	4/ 0.157	10.5/ 0.413	30/ 1.181	10.5/ 0.413	M6	6/ 53.1	M10	18/ 159.3	-	-	-	S _T
XT3	F-P	30/ 1.181	4/ 0.157	10.5/ 0.413	30/ 1.181	10.5/ 0.413	M8	8/ 70.8	M10	18/ 159.3	-	-	-	S _T
XT4	F-P-W	30/ 1.181	10/ 0.394	10.5/ 0.413	30/ 1.181	10.5/ 0.413	M8	8/ 70.8	M10	18/ 159.3	-	-	-	S _T
XT5	F-P-W	40/ 1.575	10/ 0.394	11/ 0.433	40/ 1.575	11/ 0.433	M10	28/ 247.8	M10	18/ 159.3	R	-	-	S _T
XT6	F-W	80/ 3.15	5/ 0.197	3x13/ 0.512	3x45/ 1.772	13/ 0.512	M6	9/ 79.7	M12	30/ 265.5	R	-	-	S _T
XT7-XT7M	F	80/ 3.15	2x10/ 0.394	3x13/ 0.512	4x45/ 1.772	13/ 0.512	M10	18/ 159.3	M12	40/ 354	R	-	-	S _T

Terminals for copper cables - FCCu

CB	Type of terminal	Vers.	Cable		Inner dimensions [mm/in]	Tightening [Nm/lb-in]	L cable stripping [mm/in]	Terminal covers height [mm/in]			Phase separators height [mm/in]"		
			AWG/ kcmil	mm ²				Cable or busbar/ Terminal	2/ 0.08	50/ 1.97	60/ 2.36	25/ 0.98	100/ 3.94
XT1	internal ⁽¹⁾	F-P	1x14...1/0	1x2.5...70	12x12/ 0.472x0.472	7/62	12/0.47	-	R	-	S _{CB}	R	R
XT1	internal	F-P	1x14...1/0	1x1.5...70	12x16/ 0.472x0.63	7/62	16/0.63	-	R	-	S _{CB}	R	R
XT2	internal	F-P-W	1x14...1/0	1x1...95	14x14/ 0.551x0.551	7/62	14/0.55	-	R	-	S _{CB}	R	R
XT3	internal	F-P	1x10...250	1x6...185	18x20/ 0.709x0.787	14/124	20/0.79	-	-	R	S _{CB}	R	R
XT4	internal	F-P-W	1x10...250	1x6...185	18x20/ 0.709x0.787	14/124	20/0.79	-	-	R	S _{CB}	R	R

(1) Not suitable for MA trip units.

W Width P Plug-in S_{CB} Supplied as standard with circuit-breaker, not available in the loose terminals kit
H Hole height W Withdrawable S_T Supplied as standard with the terminals kit
D Depth Ø Diameter
F Fixed R On Request

Power connection



Internal FCCuAl terminal for copper/aluminum cables



Internal FCCuAl terminal for copper and aluminum cable with take-up of auxiliary voltage



FCCuAl external terminal with cable



FCCuAl internal terminal with cable



FCCuAl external terminal with cables

Terminals for copper/aluminium cables - FCCuAl

CB	Type of terminal	Vers.	Cable	Tightening		L cable stripping height	Terminal covers				Phase separators height				
				[Nm/lb-in]	[mm/in]		[mm/in]	[mm/in]	[mm/in]	[mm/in]					
			AWG/ kcmil	mm ²	Terminal/ CB	Cable or busbar/ Terminal	2/ 0.08	50/ 1.97	60/ 2.36	68/ 3.93	25/ 0.98	100/200/ 3.94	7.87		
XT1	internal	F-P	1x10...2/0	1x6...70	3.4/30	M4	≤10mm ² (8 AWG):4.5/40 >10mm ² (8 AWG) 9/80	14/0.55	-	R	-	-	S _{CB}	R	R
	internal	F-P-W	1x14...1/0	1x2.5...50	2.5/22	3/16	≤10mm ² (8 AWG):4.5/40 >10mm ² (8 AWG) 5.7/50	15.5/0.61	-	R	-	-	S _{CB}	R	R
XT2	internal	F-P-W	1x10...2/0	1x6...70	3.4/30	M4	≤10mm ² (8 AWG):4.5/40 >10mm ² (8 AWG) 9/80	14/0.55	-	R	-	-	S _{CB}	R	R
	internal	F-P	1x14...1/0	1x2.5...50	9/80	slot	≤6mm ² (10 AWG) 2.3/20.4 >6mm ² (10AWG) 5.6/50	15.5/0.61	-	-	R	-	S _{CB}	R	R
XT3	internal	F-P	1x4...300	1x35...150	9/80	M6	22.6/200	20/0.79	-	-	R	-	S _{CB}	R	R
	internal	F-P-W	1x14...1/0	1x2.5...50	9/80	slot	≤6mm ² (10 AWG) 2.3/20.4 >6mm ² (10AWG) 5.6/50	15.5/0.61	-	-	R	-	S _{CB}	R	R
XT4	internal	F-P-W	1x4...300	1x35...150	9/80	M6	22.6/200	20/0.79	-	-	R	-	S _{CB}	R	R
	external ⁽¹⁾	F-P-W	1x3/0...350	1x95...185	10/88.5	M6	22.6/200	27/1	-	S _T	R	-	S _{CB}	R	R
XT5	internal	F-P-W	1x6...350	1x35...185	28/250	M8	35/310		R	-	R	-	S _{CB}	R	R
	external	F-P-W	1x4/0...500	1x120...240	28/250	M8	43/380		R	-	R	-	S _{CB}	R	R
XT6	internal	F-P-W	2x2/0...500	2x70...240	28/250	M8	31/275		-	-	R	-	S _T	-	-
	external	F-P-W	2x250-500	2x120...240	5/44	M8	31/275		-	-	S _T	-	-	-	-
XT7	external	F-W	3x2/0...400	3x70...185	9/80	M10	34/300.92(2/0-4/0) 43/380.58(250-400)		-	-	S _T	-	-	-	-
	external	F	4x4/0...500	4x120...240	18/160	M10	43/380	30/1.18	-	-	-	S _T	-	-	-
XT7	external	F	3x500...750	4x240...380	18/160	M10	67/593	30/1.18	-	-	-	S _T	-	-	-

(1) To be mounted on EF terminals supplied with the kit

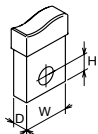

W Width
H Hole height
D Depth
F Fixed
P Plug-in
W Withdrawable
Ø Diameter
R On Request
S_{CB} Supplied as standard with circuit-breaker, not available in the loose terminals kit
S_T Supplied as standard with the terminals kit



Terminal for flexible busbars (FB)



FB terminal with flexible busbars

Terminals for flexible busbars - FB

CB	Type of terminal	Vers.	Busbar dimensions MIN [mm]			Busbar dimensions MAX [mm]			Tightening [mm]	Terminal covers height [mm/in]			Phase separators height [mm/in]		
			W	D	Nr	W	D	Nr		Cable or busbar/ Terminal	2/ 0.08	50/ 1.97	60/ 2.36	25/ 0.98	100/ 3.94
XT1	internal	F-P	10/ 0.394	0.8/ 0.031	2/ 0.078	10/ 0.394	0.8/ 0.031	9/ 0.354	7/ 61.95	-	R	-	S _{CB}	R	R
XT2	internal	F-P-W	10/ 0.394	0.8/ 0.031	2/ 0.078	10/ 0.394	0.8/ 0.031	9/ 0.354	7/ 61.95	-	R	-	S _{CB}	R	R
XT3	internal	F-P	16/ 0.629	0.8/ 0.031	2/ 0.078	16/ 0.629	0.8/ 0.031	10/ 0.394	14/ 123.91	-	-	R	S _{CB}	R	R
XT4	internal	F-P-W	16/ 0.629	0.8/ 0.031	2/ 0.078	16/ 0.629	0.8/ 0.031	10/ 0.394	14/ 123.91	-	-	R	S _{CB}	R	R



Multi-cable terminals (MC)



Multi-cable terminals with cables

Multi-cable terminals - MC Cu⁽¹⁾

CB	Type of terminal	Vers.	Cable		Tightening [Nm/lb-in]	L cable stripping [mm/in]	Terminal covers height [mm/in]			Phase separators height [mm/in]				
			AWG/ kcmil	mm ²			Terminal/ CB	Cable or busbar/ Terminal	2/ 0.08	50/ 1.97	60/ 2.36	25/ 0.98	100/ 3.94	200/ 7.87
XT1	external	F-P	6x14...2	6x2.5...35	6/53.1	7/61.95	10, 20, 30 / 0.394, 0.787, 1.181	-	S _T	-	-	-	-	-
XT2	external	F-P-W	6x14...2	6x2.5...35	6/53.1	7/61.95	10, 20, 30 / 0.394, 0.787, 1.181	-	S _T	-	-	-	-	-
XT3 ⁽²⁾	external	F-P	6x12...2	6x2.5...35	8/70.8	7/61.95	15, 30 / 0.591, 1.181	-	-	S _T	-	-	-	-
XT4 ⁽²⁾	external	F-P-W	6x12...2	6x2.5...35	8/70.8	7/61.95	15, 30 / 0.591, 1.181	-	-	S _T	-	-	-	-

(1) Installation on load side only
 (2) Take up auxiliary voltage device included



Rear horizontal terminals (R)



R terminal with horizontal busbar



R terminal with vertical busbar

Rear horizontal terminals - R

CB	Vers.	Busbar dimensions MAX [mm]				Tightening [Nm/lb-in]	Terminal covers height [mm/in]			Phase separators height [mm/in]					
		W	H	D	Ø		Terminal/CB	Cable or busbar/ terminal	2/ 0.08	50/ 1.97	60/ 2.36	25/ 0.98	100/ 3.94	200/ 7.87	
XT1 ⁽¹⁾	F	15/ 0.590	7.5/ 0.295	5/ 0.196	6.5/ 0.255	M5	5/44.2	M6	6/53.1	S _T	-	-	-	-	-
XT2	F	20/ 0.787	9/ 0.354	4/ 0.157	8.5/ 0.335	M6	6/53.1	M8	6/53.1	S _T	-	-	-	-	-
XT3	F	20/ 0.787	9/ 0.354	6/ 0.236	8.5/ 0.335	M8	8/70.8	M8	8/70.8	S _T	-	-	-	-	-
XT4	F	20/ 0.787	9/ 0.354	6/ 0.236	8.5/ 0.335	M8	8/70.8	M8	8/70.8	S _T	-	-	-	-	-
XT5	F	30/ 1.181	20/ 0.787	10/ 0.394	11/ 0.433	M10	28/247.8	M10	18/159.3	S _T	-	-	-	-	-
XT6	F	50/ 1.968	20/ 0.787	5/ 0.197	14/ 0.551	M6	18/159.3	M12	30/265.5	S _T	-	-	-	-	-

(1) Not suitable for MA trip units

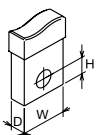

W Width P Plug-in S_{CB} Supplied as standard with circuit-breaker, not available in the loose terminals kit
 H Hole height W Withdrawable S_T Supplied as standard with the terminals kit
 D Depth Ø Diameter
 F Fixed R On Request

Power connection



Rear orientable terminal - HR VR

Rear horizontal terminals - R

CB	Vers.	Busbar dimensions MAX [mm/in]				Tightening [Nm/lb-in]			Terminal covers height [mm/in]			Phase separators height [mm/in]		
		W	H	D	Ø	Terminal/CB	Cable or busbar/terminal	2/0.08	-	68/2.36	25/0.98	100/3.94	200/7.87	
XT7 - F		50/	14/	2x10/	2x11/	M10	20/	M10	40/	S _T	-	-	-	-
XT7 M		1.96	0.55	0.394	0.433		177.01		354.02					

Terminals for fixed part

Extended front terminals for fixed part - EF

CB	Vers.	Busbars dimensions MAX [mm/in]			Cables terminals [mm/in]		Tightening [Nm/lb-in]			Phase separators height [mm/in]		
		W	D	Ø	W	Ø	Terminal/CB	Cable or busbar/ Terminal	100/3.94	200/7.87		
XT1	P	20/0.787	5/0.197	6.5/0.335	21/0.827	6.5/0.256	M6	6/53.1	M6	9/79.7	S _T	R
XT2	P-W	20/0.787	5/0.197	6.5/0.335	21/0.827	6.5/0.256	M6	6/53.1	M6	9/79.7	S _T	R
XT3	P	25/0.984	8/0.315	8.5/0.335	30/1.181	8.5/0.335	M6	6/53.1	M8	18/159.3	S _T	R
XT4	P-W	25/0.984	8/0.315	8.5/0.335	30/1.181	8.5/0.335	M6	6/53.1	M8	18/159.3	S _T	R
XT5	P-W	25/1.180	15/0.591	10/0.397	30/1.182	10/0.397	-	-	M10	18/159.3	S _T	R
XT6	W	50/1.968	5/0.197	14/0.551	50/1.97	14/0.551	-	9/19.65	M14	30/265.5	-	-
XT7	W	50/1.968	2x 10/0.394	11/0.433	4x 20/0.787	11/0.433	M5	12/106.2	M10	40/354	-	-



EF terminals for fixed part

Rear flat horizontal terminals for fixed part - HR

CB	Vers.	Busbars dimensions MAX [mm/in]			Cables terminals [mm/in]		Tightening [Nm/lb-in]		Rear Separators [mm/in]	
		W	D	Ø	W	Ø	Terminal/CB	Cable or busbar/ Terminal	90/3.543	
XT1	P	20/0.787	4	8.5/0.335	20/0.787	8.5/0.335	6/53.1	9/79.7	R	
XT2	P-W	20/0.787	4	8.5/0.335	20/0.787	8.5/0.335	6/53.1	9/79.7	R	
XT3	P	25/0.984	6	8.5/0.335	25/0.984	8.5/0.335	6/53.1	9/79.7	R	
XT4	P-W	25/0.984	10	8.5/0.335	25/0.984	8.5/0.335	6/53.1	9/79.7	R	
XT5 400A	P-W	25/0.984	5/0.197	11/0.433	25/0.984	11/0.433	-	18/159.4	R	
XT5 600A	P-W	40/1.575	8/0.315	11/0.433	40/1.575	11/0.433	-	18/159.4	R	
XT6	W	50/1.969	5/0.197	14/0.551	50/1.969	14/0.551	-	30/265.6	-	
XT7 - XT7 M	W	50/1.969	2x10/0.394	2x11/0.433	4x20/0.787	11/0.433	12/106.2	40/354.2	-	



HR terminals for fixed part XT1...XT4

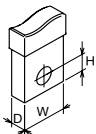

W Width	P Plug-in	S _{CB} Supplied as standard with circuit-breaker, not available in the loose terminals kit
H Hole height	W Withdrawable	S _T Supplied as standard with the terminals kit
D Depth	Ø Diameter	
F Fixed	R On Request	



VR terminals for fixed part XT1...XT4

Rear flat vertical terminals for fixed part - VR

CB	Vers.	Busbars dimensions MAX [mm/in]			Cables terminals [mm/in]		Tightening [Nm/lb-in]	Rear Separators [mm/in]	
		W	D	Ø	W	Ø	Terminal/CB	Cable or busbar/ Terminal	90/3.543
XT1	P	20/0.787	4	8.5/0.335	20/0.787	8.5/0.335	6/53.1	9/79.7	R
XT2	P-W	20/0.787	4	8.5/0.335	20/0.787	8.5/0.335	6/53.1	9/79.7	R
XT3	P	25/0.984	6	8.5/0.335	25/0.984	8.5/0.335	6/53.1	9/79.7	R
XT4	P-W	25/0.984	10	8.5/0.335	25/0.984	8.5/0.335	6/53.1	9/79.7	R
XT5 400A	P-W	25/0.984	5/0.197	11/0.433	25/0.984	11/0.433	-	18/159.4	R
XT5 600A	P-W	40/1.575	8/0.315	11/0.433	40/1.575	11/0.433	-	18/159.4	R
XT6	W	50/1.969	5/0.197	14/0.551	50/1.969	14/0.551	-	30/265.6	-
XT7 - XT7 M	W	50/1.969	2x10/0.394 2x11/0.433	4x20/0.787 11/0.433	12/106.2	40/354.2	-	-	-

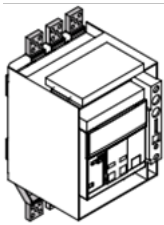

Extended front terminal - HR VR

Front extended spread terminals for fixed part - ES

CB	Vers.	Busbars dimensions MAX [mm/in]			Cables terminals [mm/in]		Tightening [Nm/lb-in]	Rear Separators [mm/in]		
		W	D	Ø	W	Ø	Terminal/CB	Cable or busbar/ Terminal	100/ 3.94	200/ 7.87
XT7 - XT7 M	W	80/3.15	2x10/0.394 3x13/0.511	4x45/1.771 13/0.511	M6 12/106.2	M12 40/354.2	R	R		

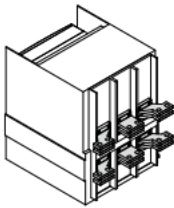

Horizontal rear terminals -SHR

Horizontal rear spread terminals for fixed part -SHR

CB	Vers.	Busbar dimensions MAX [mm]			Cable terminals [mm]		Tightening [Nm/lb-in]	Cable or busbar/ Terminal	
		W	D	Ø	W	Ø	Terminal/CB	Cable or busbar/ Terminal	
XT7 - XT7 M	W	60/2.362	2x10/0.394 2x11/0.433	4x30/1.18 11/0.433	M10 40/354.2	M10 40/354.2			

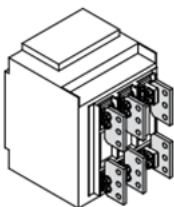

Terminal for cable FcCuAl 4x240mm² - FCCuAl

Front copper/aluminium cables for fixed part - FCCuAl

CB	Vers.	Cables terminals [mm/in]		Tightening [Nm/lb-in]	Cable or busbar / Terminal	
		Rigid	Flexible	Terminal/CB		
XT7 - XT7 M	W	6x25/0.984	6x25/0.984	M10 48/425	M12 70/620	
		4x35/1.378	4x35/1.378	M14		

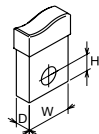

W Width P Plug-in S_{CB} Supplied as standard with circuit-breaker, not available in the loose terminals kit
 H Hole height W Withdrawable S_r Supplied as standard with the terminals kit
 D Depth Ø Diameter
 F Fixed R On Request

Auxiliary contacts - AUX

The SACE Tmax XT circuit-breakers can be equipped with auxiliary contacts that signal the status of the breaker and can be routed outside the circuit-breaker itself. The following information is available:

- **open/closed (Q):** indication of the status of the circuit-breaker power contacts;
- **trip (SY):** signals that the circuit-breaker is opening due to the intervention of the trip unit, or to the intervention residual current device, or to the opening of undervoltage/shunt opening releases, or to the use of the emergency opening pushbutton of the motor operator, or to the use of the test button;
- **trip unit tripping (S51):** indicates that one of the protection functions of the electronic or thermal-magnetic trip unit has tripped. In case of the Tmax XT5 equipped with thermal-magnetic trip unit and residual current device, S51 is activated also by the intervention of the residual current device.
- **YO/YU tripping (S52):** indicates that the under voltage or shunt opening release has been activated. The signaling depends on the service release used. For Tmax XT6 S52 can be used only with YU and is not available for YO. For Tmax XT5, in case of YO, shunt opening release must be permanently supplied to maintain the S52 signal.

AUX for XT1, XT2, XT3, XT4, XT5 and XT6

Circuit -breakers	XT1-XT3		XT2-XT4		XT5			XT6					
AUX	Q	SY	Q	SY	S51	Q	SY	S51	S52	Q	SY	S51	S52
24V DC	■	■	■	■	■	■	■	■	■	■	■	■	■
250V AC/DC	■	■	■	■	■	■	■	■	■	■	■	■	■
400V AC	-	-	■	■	-	■	■	-	-	-	-	-	-

24V DC and 250V AC/DC auxiliary contacts

Auxiliary contacts Q (open/closed), SY (trip), S51 (trip unit tripping) and S52 (YO/YU tripping) status during sequences

Actions	Q	SY	S51	S52
Normal Sequence				
CB Opened	12	96	06	26
CB Closed	14	96	06	26
Trip sequence (caused by: Trip Test)				
CB Opened	12	96	06	26
CB Closed	14	96	06	26
CB Tripped	12	98	06	26
CB Reset	12	96	06	26
Trip sequence (caused by: trip unit)				
CB Opened	12	96	06	26
CB Closed	14	96	06	26
CB Tripped	12	98	08	26
CB Reset	12	96	06	26
Trip sequence (caused by: YU / YO)				
CB Opened	12	96	06	26
CB Closed	14	96	06	26
CB Tripped	12	98	06	28
CB Reset	12	96	06	26

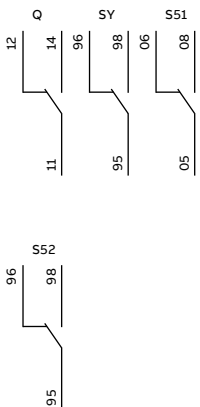

Signaling



Cabled auxiliary contact



Uncabled auxiliary contact



Cabled auxiliary contact for withdrawable circuit-breaker

250V AC/DC and 24V AC/DC auxiliary contacts are installed without the need for any screws. They are extremely easy to fit. Simply apply a slight pressure in the appropriate place. The following versions of auxiliary contacts are available:

- cabled (AWG20 cable section -0.5mm²):
 - for fixed/plug-in circuit-breakers with 3.28ft long cables;
 - for withdrawable circuit-breakers with fixed part and moving part connector;
- not cabled:
 - for fixed/plug-in circuit-breakers with cables from AWG 20 up to AWG 15 cross-section.

Auxiliary contacts are supplied for each circuit-breaker in the SACE XT family in various different combinations, as shown in the table. The following items can be ordered to make the installation even more flexible:

- an uncabled auxiliary contact can generate different signals (Q, SY or S52) according to the position where the circuit-breaker is installed;
- an uncabled S51 auxiliary contact, which can be used for XT2, XT4, XT5 and XT6 circuit-breakers;
- a cabled auxiliary contact, with unnumbered cables. It can generate different signals (Q, SY or S52) according to the position where the circuit-breaker is installed.

Combinations of cabled auxiliary contacts with numbered cables	XT1	XT2	XT3	XT4
	3/4p	3/4p	3/4p	3/4p
1Q 1SY 24V DC	F-P	F-P-W	F-P	F-P-W
3Q 1SY 24V DC	-	F-P-W	F-P	F-P-W
1S51 24V DC	-	F-P-W	-	F-P-W
1Q 1SY 250V AC/DC	F-P	F-P-W	F-P	F-P-W
2Q 2SY 1S51 250V AC/DC	-	F-P-W	-	F-P-W
3Q 2SY 250V AC/DC	-	F-P-W	-	F-P-W
3Q 1SY 250V AC/DC	-	F-P-W	F-P	F-P-W
1S51 250V AC/DC	-	F-P-W	-	F-P-W
2Q 1SY 250V AC/DC	F-P	F-P	F-P	F-P
3Q on the left 250V AC/DC	F-P	F-P	F-P	F-P

F = Fixed, P = Plug-in, W = Withdrawable

Combinations of cabled auxiliary contacts with numbered cables	XT5	XT6
	Thermal-magnetic and Ekip Dip trip unit	Ekip Touch and Hi-Touch trip unit
1Q + 1SY on the left 24V DC	F-P	-
1Q + 1SY 24V DC	F-P-W	F-P-W
3Q + 1SY 24V DC	F-P-W	F-P-W
1S51 24V DC	F-P-W	F-P-W
1S52 24V DC	F-P-W	F-P-W
1Q + 1SY on the left 250V AC/DC	F-P	-
1Q + 1SY 250V AC/DC	F-P-W	F-P-W
2Q + 1SY 250V AC/DC	F-P-W	F-P-W
3Q + 1SY 250V DC	F-P-W	F-P-W
1S51 250V AC/DC	F-P-W	F-P-W
1S52 250V AC/DC	F-P-W	F-P-W

F = Fixed, P = Plug-in, W = Withdrawable

Auxiliary contacts 24V DC - 250V AC/DC

	3-pole circuit-breaker	4-pole circuit-breaker
XT1		
XT3		
XT2 XT4		
XT2 XT4 with Ekip Touch and Hi-Touch trip units		
XT5		
XT5 with Ekip Touch and Hi-Touch trip units		
XT6		

Signaling

AUX 250V AC/DC - Electrical specifications

Power supply voltage	Operating current according to the utilization category					
	AC-15	AC-14	AC-13	DC-14	DC-13	DC-12
250V AC	4 A	5 A	6 A	-	-	-
125V AC	5 A	6 A	6 A	-	-	-
250V DC	-	-	-	0.03 A	0.03 A	0.3 A
110V DC	-	-	-	0.05 A	0.05 A	0.5 A

AUX 24V DC - Electrical specifications

Power supply voltage	Operating current
5 V DC	0.001 A
30 V DC	0.1 A

400V AC auxiliary contacts

400V AC auxiliary contacts are available only for the XT2, XT4 and XT5 circuit-breakers in the following versions:

- cabled (AWG17 cable section -1mm²):
 - for fixed/plug-in circuit-breakers with 3.28ft long cables;
 - for withdrawable circuit-breakers with a fixed part and moving part connector.

With the XT2 and XT4, the 400V auxiliary contacts take up the whole right-hand slot of the circuit-breaker. For the XT5 1Q+1SY, the 400V auxiliary contacts are available only with thermal-magnetic or Ekip Dip trip units.



Cabled auxiliary contact

Combinations	XT2	XT4	XT5
	3/4p	3/4p	3/4p
1Q 1SY 400V	F-P-W	F-P-W	F-P-W ⁽¹⁾
2Q 400V	F-P-W	F-P-W	F-P-W

F = Fixed, P = Plug-in, W = Withdrawable

(1) Only for circuit-breakers with thermal-magnetic or Ekip Dip trip units.

400V AC auxiliary contacts

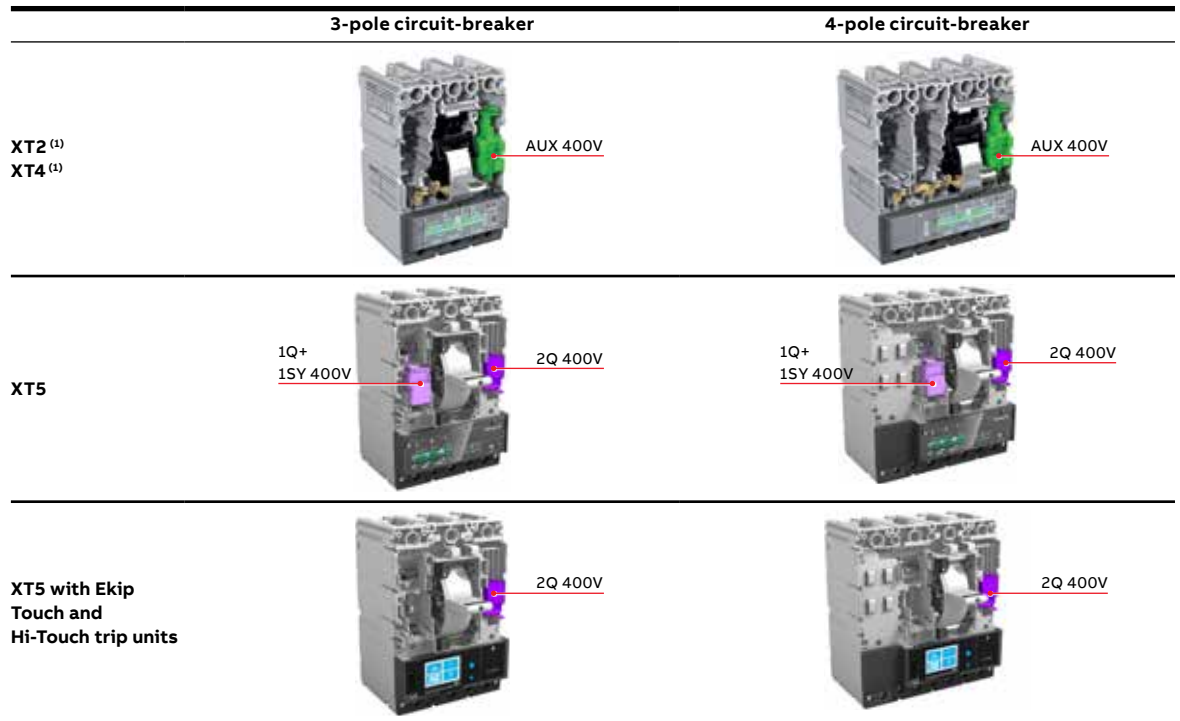

(1) Not available with Ekip Touch and Hi-Touch trip units

AUX 400V AC - Electrical specifications

Power supply voltage [V]	Operating current [A]	
	AC	DC
125 AC/DC	-	0.5
250 AC/DC	12	0.3
400 AC ⁽¹⁾	3	-

(1) Only ENEC approved

Signaling

AUX for XT7 and XT7 M

Circuit -breakers	XT7				XT7 M		
	Q	SY	S51	S52	Q	S51	RTC
24V DC	■	■	■	■	■	■	■
250V AC/DC	■ ⁽¹⁾	■ ⁽¹⁾	■	■	■ ⁽¹⁾	■	■
400V AC	■	■	-	-	■	-	-

(1) Same commercial code of AUX 400V

Open / closed auxiliary contacts - Q

The XT7 and XT7 M circuit-breakers can be equipped with auxiliary contacts that signal the open or closed status of the circuit-breaker. The contacts are available in the following configurations:

Open / closed auxiliary contacts (AUX 4Q)	XT7	XT7 M
4 auxiliary contacts	4Q 400V AC/DC	■
	4Q 24V DC	■
	2Q 400V AC/DC + 2Q 24V DC	■
15 auxiliary contacts	15Q 400V AC/DC	■
	15Q 24V DC	■

	400V/250V AC/DC contact	24V DC contact
Type	Changeover contacts	Changeover contacts
Minimum load	100mA @ 24V	1mA @ 5V
Breaking capacity		
DC	24V	-
	125V	0.3A @ 10ms
	250V	0.15A @ 10ms
AC	250V	5A @ cosφ 1
		5A @ cosφ 0.7
		5A @ cosφ 0.3
	400V	3A @ cosφ 1
		2A @ cosφ 0.7
		1A @ cosφ 0.3

The AUX 15Q is an alternative to the mechanical interlock (MI), the DLC for XT7 M lock or the DLP lock if mounted on the right side.



Open and close auxiliary contacts



15 auxiliary contacts

Trip auxiliary contact - SY

The XT7 circuit-breakers can be equipped with auxiliary contacts that signal that the circuit-breaker is opening due to the intervention of the trip unit, or to the opening of undervoltage/shunt opening releases, or to the use of the test button. The contacts are available in the following configurations:

		400V/250V AC/DC contact	24V DC contact
Type		Switching	Switching
Minimum load		100mA @ 24V	1mA @ 5V
Breaking capacity			
DC	24V	-	0.1A
	125V	0.3A	-
	250V	0.15A	-
AC	250V	12A	-
	400V	3A	-

Contact signaling the tripping of the protection unit Ekip – S51

This contact signals the opening of the circuit-breaker after the Ekip protection trip unit has tripped.

The contact is available for the XT7 and XT7 M.

For the XT7 M circuit-breaker, the closing operation can be carried out only after the “TU Reset” push-button has been restored to its normal operating position. The switching contact can also be associated with an optional accessory for remote resetting - YR.



Contact signaling the tripping of the Ekip trip unit protection - S51

		250V AC/DC contact	24V DC contact
Type		Switching	Switching
Minimum load		100mA @ 24V	1mA @ 5V
Breaking capacity			
DC	24V	-	0.1A
	250V	0.5A @ 0ms / 0.2A @ 10ms	-
	AC	250V	3A @ cosφ 0.7

Contact signaling tripping of the YO/YU – S52

This contact signals that the undervoltage (YU) or the shunt opening release (YO) have been activated.

The contact is the same and depends on the service release mounted in the dedicated position.

It is available for the XT7 only.

		250V AC/DC contact	24V DC contact
Type		Switching	Switching
Minimum load		100mA @ 24V	1mA @ 5V
Breaking capacity			
DC	24V	-	0.1A
	250V	0.5A @ 0ms / 0.2A @ 10ms	-
	AC	250V	3A @ cosφ 0.7

Signaling

Auxiliary Position Contacts – AUP

Auxiliary position contacts provide information about the position of the circuit-breaker in relation to the fixed part of plug-in or withdrawable versions.

Three types of position contacts (AUPs) are available:

- racked-in contact for all plug-in and withdrawable Tmax XT circuit-breakers;
- racked-out contact for all withdrawable Tmax XT circuit-breakers;
- test contact for withdrawable Tmax XT5, XT6, XT7 and XT7 M circuit-breakers.

Circuit-breaker		Max number of racked-in contacts	Max number of test contacts	Max number of racked-out contacts	Max number of AUP
XT1	3/4 poles	4	-	-	4
XT2	3 poles	2	-	2	4
	4 poles	4	-	2	6
XT3	3/4 poles	4	-	-	4
XT4	3/4 poles	4	-	2	6
XT5	3/4 poles	3	1	1	5
XT6	3/4 poles	3	1	1	5
XT7	3/4 poles	2	2	2	6
XT7 M	3/4 poles	2	2	2	6

Auxiliary position contacts, which provide electrical signaling of the circuit-breaker position in relation to the fixed part, are available in the following versions:

AUP	XT1	XT2	XT3	XT4	XT5	XT6	XT7	XT7 M
24V DC	■	■	■	■	■	■	■	■
250V AC/DC	■	■	■	■	■	■	■ ⁽¹⁾	■ ⁽¹⁾
400V AC	-	-	-	-	-	-	■	■

(1) Same commercial code of AUX 400V

AUP for XT1, XT2, XT3 and XT4

AUX 250V AC - Electrical specifications

Power supply voltage [V]	Operating current according to the utilization category					
	AC-15	AC-14	AC-13	DC-14	DC-13	DC-12
250V AC	4 A	5 A	6 A	-	-	-
125V AC	5 A	6 A	6 A	-	-	-
250V DC	-	-	-	0.03 A	0.03 A	0.3 A
110V DC	-	-	-	0.05 A	0.05 A	0.5 A

AUX 24V DC - Electrical specifications

Power supply voltage	Operating current
5V DC	0.001 A
24V DC	0.1 A



Auxiliary position contact

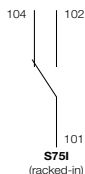

Plug-in circuit-breaker with racked-in contact



S75I=104

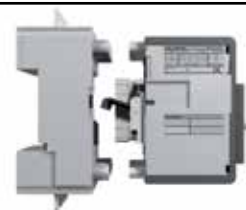

S75I=102

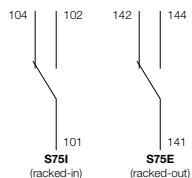

Withdrawable circuit-breaker with racked-in/racked-out contacts



S75I=102
S75E=144



S75I=102
S75E=142



S75I=104
S75E=142

AUP for XT5 and XT6

AUX 25V AC/DC - Electrical specifications

Power supply voltage	Operating current according to class of use					
	AC-15	AC-14	AC-13	DC-14	DC-13	DC-12
250V AC	4A	5A	6A	-	-	-
125V AC	5A	6A	6A	-	-	-
250V DC	-	-	-	0.03A	-	0.3A
110V AC	-	-	-	0.05A	-	0.5A

AUX 25V DC - Electrical specifications

Power supply voltage	Operating current
5V DC	0.001A
24V DC	0.1A

AUP for XT7 and XT7 M

		400V/250V AC/DC contact	24V DC contact
Type		Changeover contacts	Changeover contacts
Minimum load		100mA @ 24V	1mA @ 5V
Breaking capacity			
DC	24V	-	0.1A
	125V	0.3A @ 10ms	-
	250V	0.15A @ 10ms	-
AC	250V	5A @ cosφ 1	-
		5A @ cosφ 0.7	-
		5A @ cosφ 0.3	-
	400V	3A @ cosφ 1	-
		2A @ cosφ 0.7	-
		1A @ cosφ 0.3	-



Auxiliary position contact



Auxiliary position contacts - AUP

Signaling



—
Early Auxiliary Contacts

Early Auxiliary Contacts – AUE

Early closing auxiliary contacts: these allow the undervoltage release to be supplied before the main contacts close, in accordance with IEC 60204-1 and VDE 0113 standards. Early opening auxiliary contacts: these allow any electronic devices connected to the system to be disconnected in advance before the system is damaged by an overvoltage caused by the circuit-breaker opening. The early opening/closing auxiliary contacts can be installed inside the direct and transmitted rotary handle operating mechanisms for all the SACE Tmax XT family circuit-breakers except for the XT7 (max two contacts @ 400V):

- the cabled version includes 3.28ft long cables (AWG20 cable sections);
- a dedicated code is available in the withdrawable version which includes the connector for the moving and fixed parts;

For the XT7 with a lever operating mechanism, these are mounted directly on the circuit-breaker.

	XT1	XT2	XT3	XT4	XT5	XT6	XT7	XT7 M
AUE closing	■	■	■	■	■	■	■	-
AUE opening	■	■	■	■	-	-	-	-

Early Auxiliary Contacts – AUE for XT7

400V/250V AC/DC contact		
Type	Switching	
Minimum load	100mA @ 24V	
Breaking capacity		
DC	125V	0.3A
	250V	0.15A
AC	250V	12A
	400V ⁽¹⁾	3A

(1) Only ENEC approved



—
Ready to close
signaling contact

Ready to close signaling contact - RTC

The ready to close signaling contact – RTC – indicates that the circuit-breaker is ready to receive the closing command and is available only for the XT7 M. The circuit-breaker is ready to close when the following conditions are fulfilled:

- the circuit-breaker is open
- the springs are loaded
- there are no opening command or locks on the opening command
- the circuit-breaker is reset following tripping of the Ekip protection trip unit.

		250V AC/DC contact	24V DC contact
Type		Switching	Switching
Minimum load		100mA @ 24V	1mA @ 5V
Breaking capacity			
DC	24V	-	0.1A
	250V	0.5A @ 0ms / 0.2A @ 10ms	-
	250V	3A @ cosφ 0.7	-
AC	250V	3A @ cosφ 0.7	-

Contact signaling loaded springs - S33 M/2

This contact is available for XT7 M only and signals the spring status of the circuit-breaker operating mechanism. It is available in both 400V AC/DC and 24V DC versions and it is not included in the motor but must be order separately.

		400V AC/DC contact	24V DC contact
Type		Changeover contacts	Changeover contacts
Minimum load		100mA @ 24V	1mA @ 5V
Breaking capacity			
DC	24V	-	0.1A
	125V	0.3A @ 10ms	-
	250V	0.15A @ 10ms	-
AC	250V	5A @ cosφ 1	-
		5A @ cosφ 0.7	-
		5A @ cosφ 0.3	-
	400V	3A @ cosφ 1	-
		2A @ cosφ 0.7	-
		1A @ cosφ 0.3	-

Mechanical signaling of tripping the protection trip unit - TU Reset

XT7 M circuit-breakers are always equipped with a mechanical device that signals the tripping status of the protection trip units. After the Ekip trip unit has been tripped due to an electrical fault, the signaling device clearly indicates the tripping status on the front of the circuit-breaker. The circuit-breaker can be reset only after the signaling pushbutton has been restored to its normal operating position.



—
TU Reset

Operating mechanism

		XT1	XT2	XT3	XT4	XT5	XT6	XT7	XT7 M
Rotary handle operating mechanism	RHD - Direct rotary handle	■	■	■	■	■	■	■	-
	RHE - Transmitted rotary handle	■	■	■	■	■	■	■	-
	RHE_LH - Wide ("pistol") transmitted rotary handle	■	■	■	■	-	-	-	-
	RHS - Side rotary handle	■	■	■	■	■	-	-	-
	Conversion kit for telescopic rod	-	-	-	■	■	■	■	-
Flange handle operating mechanism	FH - Cable operated flange handles		■	■	■	■	-	-	-
NFPA handle	NFPA		■	■	■	■	-	-	-
Front lever op. mech.	FLD - Front for locks		-	■	-	■	■	-	-
Toggle extension	Toggle extension for operating circuit-breaker		-	-	-	-	■	■	■

Rotary handle operating mechanism

This is an operating device that allows the circuit-breaker to be operated by means of a rotary handle, which makes the circuit-breaker easier to open and close thanks to its ergonomic handgrip.

Different types of handles are available:

- direct (RHD): installed on the panel door for frontal operation;
- transmitted (RHE): installed on the panel door. It allows the circuit-breaker to be operated by means of a rod which acts on a base installed on the front of the circuit-breaker. A version (RHE-PL) with padlock on the base is also available;
- lateral (RHS): installed directly on the front of the circuit-breaker for side operations.

For the XT1, XT2, XT3 and XT4 a large handle grip (LH) is also available, which can be combined with the transmitted handle (RHE) and with the lateral handle (RHS).



(1) Available for XT5 only

All rotary handles are available in two versions:

- standard: grey color;
- emergency color: red on a yellow background. Suitable for operating machine tools.

Transmitted rotary handles can be ordered in the following ways:

- by one single commercial code (for RHD, RHE, RHS L/R);
- by listing the commercial codes of the following three components (for RHE only):
 - the base of the rotary handle to be fixed onto the circuit-breaker (RHE_B);
 - a 19.68in transmission rod (RHE_S). The minimum and maximum distances between the fixing plate and the door are 2.38in and 18.5in respectively;
 - a rotary handle on the compartment door with a normal standard handgrip (RHE_H, RHE_H LH) or emergency handgrip (RHE_H_EM, RHE_H_EM LH).

To install the lateral rotary handle (RHS) on the XT5, the transmitted rotary handle (RHE code) and the conversion kit (from RHE to RHS) must be ordered.

The use of the rotary handle is an alternative to the motor operator and to all accessories mounted on the front of the circuit-breaker.

The rotary handles can be locked by means of a wide range of key locks and padlocks (see the Chapter "Safety and Protection" - section "Locks").

The direct and transmitted rotary handle operating mechanisms allow early closing auxiliary contacts to be used when closing to supply the undervoltage release before the circuit-breaker closes.

For the XT5, XT6 and XT7 there is a special version of the RHD and RHE_B with an additional padlock (2PLL). For XT1 and XT4 there is a special version of RHE with an additional padlock on the base (2PLL).

Fig. 1
RHD XT5
additional padlock



Fig. 2
RHE XT5
additional padlock



Fig. 3
RHD XT7
additional padlock



Fig. 4
RHE XT7
additional padlock

Fig. 1

Fig. 3

Fig. 2

Fig. 4

Conversion kit for telescopic rod

This device must be installed on the rod of the extended rotary handle (RHE) and allows the panel door to be closed even with the withdrawable circuit-breaker in the racked-out position.

Operating mechanism



Flange handle

Flange handle

Installed on the panel door. It allows fixed circuit breakers to be operated in accordance with NFPA and UL508A Standards by means of cables of different length (4',6',10'), which act on a base installed on the front of the circuit breaker. Two different versions of handles are available in order to fully meet the Standard prescriptions required by the application: NEMA 1, 3, 12, 4 metallic and NEMA 1, 3, 12, 4, 4X non-metallic.



NFPA handle

NFPA handle

Thanks to this handle mounted on the shaft of the RHE mechanism, the operator is allowed to operate the circuit breaker and to lock it in OFF position by means of an embedded padlock device also in case of panel door open, as prescribed by the Standards NFPA 79 and UL508A.



Front for the operating lever mechanism

Front for the lever operating mechanism

This device can be installed on the front of the circuit-breaker and for withdrawable circuit-breakers inside switchboards, it allows the IP40 degree of protection to be maintained for the whole insulation run of the circuit-breaker.

It is always fitted with a compartment door lock and with a slot for a padlock device in the open position (0.236in Ø stem up to three padlocks - not supplied) which prevents closing the circuit-breaker and the compartment door.

The front for the lever operating mechanism can only be installed on the XT2, XT4, XT5 and XT6 circuit-breakers. The front for the lever operating mechanism can be fitted with a wide range of key locks and padlocks (see the Chapter "Safety and Protection" - section "Locks").

The use of the front for the lever operating mechanism is an alternative to the motor operator and to all of the front type accessories.

Toggle extension

This device can be used to easily operate the toggle of the circuit-breaker, during manual closing and opening operations.

The device is removable and does not need screws in order to mount and operate it.

Remote control

Remote control		XT1	XT2	XT3	XT4	XT5	XT6	XT7	XT7 M
Service release	SOR - Shunt opening release	■	■	■	■	-	-	-	-
	UVR - Undervoltage release	■	■	■	■	-	-	-	-
	YO - Shunt opening release	-	-	-	-	■	■	■	■
	YU - Undervoltage release	-	-	-	-	■	■	■	■
	YC - Shunt closing release	-	-	-	-	-	-	-	■
Remote reset	YR - Resetting remotely	-	-	-	-	-	-	-	■
YO/YU Test Unit	YO/YC Test Unit	■	■	■	■	■	■	■	■
Time delay device for YU	UVD - Time delay device for YU	■	■	■	■	■	■	■	■
Motor operator	MOD	■	-	■	-	-	-	-	-
	MOE	-	■	-	■	■	■	-	-
	MOE-E	-	■	-	■	■	-	-	-
	M - Motor	-	-	-	-	-	-	-	■

Service releases

The SACE Tmax XT circuit-breakers can be fitted with service releases (shunt opening release, shunt closing release for XT7M only and undervoltage release).

XT1, XT2, XT3 and XT4

Shunt opening release – SOR

This allows the circuit-breaker to open by means of a non-permanent electrical control. Release operation is guaranteed for voltage between 70% and 110% of the rated power supply voltage U_n , in both alternating and direct current. The SOR is equipped with a built-in limit contact to shut-off the power supply in the open position with the trip unit tripped.

A remote-controlled emergency opening command can be generated by connecting an opening button to the SOR.



Cabled SOR - UVR



Cabled SOR - UVR for withdrawable circuit-breaker



Uncabled SOR - UVR

Undervoltage release – UVR

This allows the circuit-breaker to open when the release is subject either to a power failure or a voltage drop. As prescribed in the Standards, opening is guaranteed when the voltage is between 70% to 35% U_n . After tripping, the circuit-breaker can be closed again if the voltage exceeds the 85% U_n . When the undervoltage release is not energized, neither the circuit-breaker or the main contacts can be closed. A remote-controlled emergency opening command can be generated by connecting an opening button to the UVR.

None of the service releases require screws for installation. They are extremely easy to fit. Just use slight pressure in the appropriate place. All service releases are available in two versions:

- cabled (AWG 20 cable section - 0.5mm² up to 300V, AWG 17 - 1mm² up to 525V):
 - for fixed/plug-in circuit-breakers with 3.28 ft long cables;
 - for withdrawable circuit-breakers with a fixed and moving part connector;
- not cabled:
 - for fixed/plug-in circuit-breakers with cables from AWG 15 in cross-section.

Remote control

Installation in circuit-breakers:

- 3-pole: as an alternative, the SOR or UVR can be installed in the slot on the left of the operating lever;
- 4-pole: the SOR or UVR can be housed at the same time in the slot of the third and fourth pole. For withdrawable circuit-breakers, the connector for the fourth pole must be ordered to be able to install the SOR and UVR in the fourth pole. If there is a residual current release, the opening solenoid (RC Coil) of the residual current device must be installed in the slot of the third pole on the left of the operating lever.



SOR Electrical Specifications

Version	Max power absorbed on inrush		Resistance	
	AC [VA]	DC [W]	Internal [ohm]	External [ohm]
12V DC		50	2.67	0
24-30V AC/DC	50	50	11	0
48-60V AC/DC	60	60	62	0
110...127V AC-110...125V DC	50	50	248	0
220...240V AC-220...250V DC	50	50	930	0
380-440V AC	55		2300	0
480-525V AC	55		5830	0

UVR Electrical Specifications

Version	Power absorbed during normal operation		Resistance	
	AC [VA]	DC [W]	Internal [ohm]	External [ohm]
24-30V AC/DC	1.5	1.5	399	0
48V AC/DC	1	1	1447	100
60V AC/DC	1	1	2405	100
110...127V AC-110...125V DC	2	2	8351	390
220...240V AC-220...250V DC	2.5	2.5	20502	9000
380-440V AC	3		20502	39000
480-525V AC	4		20502	59000

XT5 and XT6

Shunt opening release – YO

This allows the circuit-breaker to open by means of a permanent electrical control. Release operation is guaranteed for voltages between 70% and 110% of the rated power supply voltage U_n , in both alternating and direct current. The YO can be permanently supplied.

A remote-controlled emergency opening command can be created by connecting an opening button to the YO.

Undervoltage release – YU

This allows the circuit-breaker to open when the release is subject either to a power failure or a voltage drop. As prescribed in the standards, opening is guaranteed when the voltage is between 70% to 35% U_n . After tripping, the circuit-breaker can be closed again if the voltage exceeds 85% U_n . When the undervoltage release is not energized, neither the circuit-breaker nor the main contacts can be closed. A remote-controlled emergency opening command can be generated by connecting an opening button to the YU.

None of the service releases require screws to be installed. They are extremely easy to fit: just use a slight pressure on the part indicated in the installation manual. All service releases are available in two versions:

- cabled (AWG16 - minimum cable section 1.25mm²):
 - for fixed/plug-in circuit-breakers with 3.28ft long cables;
 - for withdrawable circuit-breakers with fixed and moving part connectors;
- not cabled:
 - for fixed/plug-in circuit-breakers (suggested cables section 1.5 mm² AWG15).

For the fixed version of Tmax XT5, the YO and the YU can be mounted as an alternative in the slot on the left (third pole) or in the slot on the right (first pole) of the operating lever. For the withdrawable version of Tmax XT5, the YO and YU are installed as standard in the first pole. If two different coils are needed in the same circuit-breakers or the YO or YU are required in the third pole (on the left), an uncabled coil and the dedicated cables and connectors for the withdrawable version must be ordered.

Instead, for Tmax XT6 in each versions (withdrawable or fixed) YU can be mounted only in the third pole (on the left) and YO can be mounted only in the first pole (on the right).



Shunt opening release - YO



Undervoltage release - YU

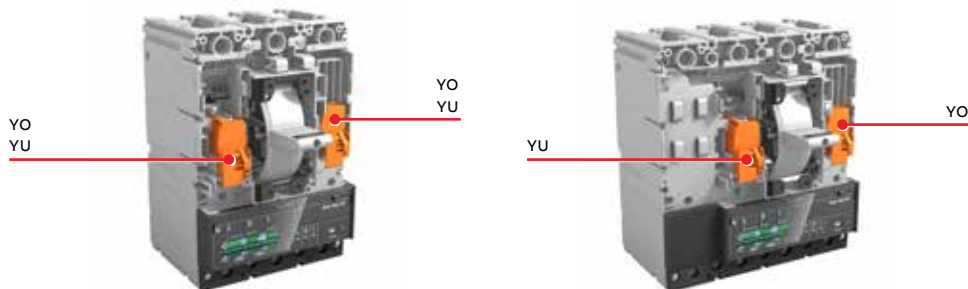

Remote control

Shunt opening release – YO

Version	Max power absorbed on inrush		Current I _{pk} Pull [A]	Power	
	AC [VA]	DC [W]		Pavg Holding [VA]	Pavg Holding [W]
12V DC	-	132	11		3.5
24-60V AC/DC	264@24V	264@24V	11	5	3.5
	660@60V	660@60V			
110...250V AC/DC	363@110V	363@110V	3.3	2.5	2
	825@250V	825@250V			
380-440V AC	304@380V	304@380V	0.8	4.7	
	352@440V	352@440V			
480-525V AC	384@480V	384@480V	0.8	6	
	420@525V	420@525V			

Undervoltage release – YU

Version	Max power absorbed on inrush		Current I _{pk} Pull [A]	Power	
	AC [VA]	DC [W]		Pavg Holding [VA]	Pavg Holding [W]
12V DC	-	132	11		3.5
24-30V AC/DC	330	330	11	6.5	4.5
48-60V AC/DC	660	660		6.5	5.5
110...127V AC-110...125V DC	419	419	3.3	5.2	3.7
220...240V AC-220...250V DC	825	825		5.2	2.6
380-440V AC	352	352	0.8	4.7	
480-525V AC	440	440		6	

XT7 and XT7M

Shunt opening and shunt closing releases - YO/YC

These opening and closing releases enable the circuit-breaker to be controlled remotely. Opening is always possible, while closing is available only for the XT7 M when the closing springs of the operating mechanism are loaded and the circuit-breakers are ready to close. The releases operate by means of minimum impulse current duration time of 100 ms. Furthermore, they can operate in permanent service. In this case, if the opening command is given by means of the opening release, the circuit-breaker can be closed by de-energizing the opening release and, after a time of at least 30 ms, by controlling the closing.

A second open release is an alternative to an undervoltage release.

General characteristics

Power supply (Un)	AC	DC
24V	■	■
30V	■	■
48V	■	■
60V	■	■
110V...120V	■	■
120V...127V	■	■
220V...240V	■	■
240V...250V	■	■
380V...400V	■	-
415V...440V	■	-
480V...500V	■	-
Operating limits	YO/YO2: 70%...110% Un	YC: 85%...110% Un
Inrush power (Ps)	300VA	300W
Continuous power (Pc)	3.5VA	3.5W
Opening time (YO/YO2)		
XT7-XT7 M	20 ms	
Closing time (YC/YC2)		
XT7-XT7 M	50 ms	



Shunt opening release



Undervoltage release

Undervoltage release – YU

The undervoltage release opens the circuit-breaker when there is a significant voltage drop or power failure. It can be used for safe remote tripping, for blocking closing or to control the voltage in the primary and secondary circuits. The power supply for the release is therefore obtained from the supply side of the circuit-breaker or from an independent source.

Circuit-breaker closing is permitted only when the release is powered. The undervoltage release is an alternative to the second shunt opening release or to the anti-racking out device.

As prescribed in the Standards, opening is guaranteed when the voltage is between 70% to 35% U_n .

After tripping, the circuit-breaker can be closed again if the voltage exceeds the 85% U_n .

General characteristics

Power supply (U_n)	AC	DC
24V	■	■
30V	■	■
48V	■	■
60V	■	■
110V...120V	■	■
120V...127V	■	■
220V...240V	■	■
240V...250V	■	■
380V...400V	■	-
415V...440V	■	-
480V...500V	■	-
Operating limits	70%...100% U_n	
Inrush power (P_s)	300VA	300W
Continuous power (P_c)	3.5VA	3.5W
Opening time (YU)		
XT7-XT7 M	30 ms	

Remote control



Remote resetting

Remote resetting - YR

Available on the XT7 M only, the YR reset coil permits the remote resetting of the circuit- breaker after a release has tripped due to an overcurrent condition.

General characteristics

Power supply (Un)	AC	DC
24V	■	■
110V	■	■
220V	■	■
Operating limits	90%...110% Un	

Opening and closing release test unit - YO/YC Test Unit

The opening and closing release test unit helps ensure that the releases are running smoothly, to guarantee a high level of reliability in controlling circuit-breaker opening. The test unit ensures the service continuity of the opening and closing releases with a rated operating voltage between 24V and 250V (AC and DC), in addition to verifying the functioning of the opening and closing coils electronic circuit. Continuity is checked cyclically at an interval of 30s between tests. The unit has optic signals via LEDs on the front, which provide the following information:

POWER ON: correct power supply of the YO/YC Test Unit;

OPEN ON: coil switch absent, power supply absent or insufficient, interrupted cables;

SHORT ON: coil switch failure, short-circuited cables;

OPEN and SHORT FLASHING: faulty coil switch or incorrect supply;

OPEN and SHORT OFF: correct operation of the coil switch.

Two relays with one change-over area are also available on board the unit, to allow remote signaling of the following events:

Test failure - resetting takes place automatically when the alarm stops;

Failure of three tests - resetting occurs only by pressing the manual RESET on the unit.

Devices characteristics

Auxiliary power supply	24...250V AC/DC
------------------------	-----------------

Specifications of the signaling relays

Maximum interrupted current	6A
Maximum interrupted voltage	250V AC



Time delay device for undervoltage release

Electronic time-delay device for undervoltage release - UVD

The undervoltage release can be combined with an electronic time-delay device for the circuit-breaker, allowing for delayed external tripping with adjustable preset times. Use of the delayed undervoltage trip unit is recommended to prevent tripping when the power supply network for the trip unit is subject to brief voltage drops or power supply failures. Circuit-breaker closing is inhibited when the UVD is not powered. The time-delay device must be used with an undervoltage release with the same voltage.

Circuit-breaker	Power supply voltage [V AC/DC]
XT1...XT4	24...30
XT1...XT4	48...60
XT1...XT4	110...125
XT1...XT4	220...250
Delay which can be set [s]	0.25 - 0.5 - 0.75 - 1 - 1.25 - 2 - 2.5 - 3
XT5 - XT6	24...30
XT5 - XT6	48...60
XT5 - XT6	110...125
XT5 - XT6	220...250
Delay which can be set [s]	0.5 - 1 - 1.5 - 2 - 3
XT7	24...30
XT7	48
XT7	60
XT7	110...125
XT7	220...250
Delay which can be set [s]	0.5 - 1 - 1.5 - 2 - 3

Motor Operators

These are devices that allow circuit-breaker opening and closing:

- in remote mode, by means of electric controls;
- locally, directly from the front, by means of a special mechanism.



Direct action motor operator (MOD)

Direct action motor operator - MOD

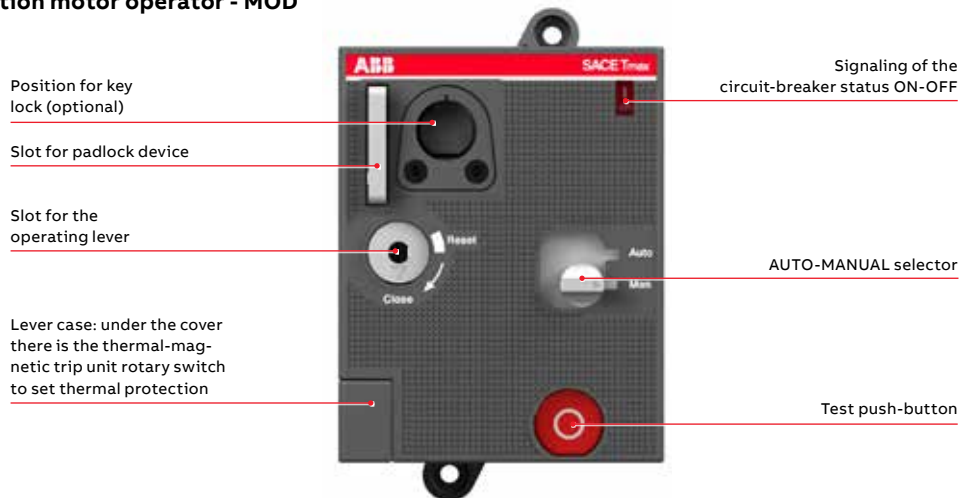

Remote control

The direct action motor operator available for XT1 and XT3 is supplied:

- with 3.28 ft long cables;
- with a flange, to replace the standard one supplied with the circuit-breaker;
- with a padlock device, only removable when the motor is in the open position. The padlock device accepts up to three 0.3 in padlocks;
- auxiliary contacts (AU-MO), which allow the motor control mode (manual or auto) signal to be routed outside;
- (on request) the motor operator can be fitted with a key lock (see the Chapter "Accessories" - section "Locks").

Operating principles:

- a selector on the front of the MOD, is used for selecting the operating mode:
 - **AUTO:** when the selector is in this position, the circuit-breaker closing is commanded remotely only by means of an electric impulse, whereas opening is allowed both remotely and from the front of the motor;
 - **MANUAL:** when the selector is in this position, the circuit-breaker can only be opened/closed from the front of the motor by means of the relative lever housed in a slot made in the motor itself;
- via remote control, guaranteed by permanent electrical opening/closing impulses.

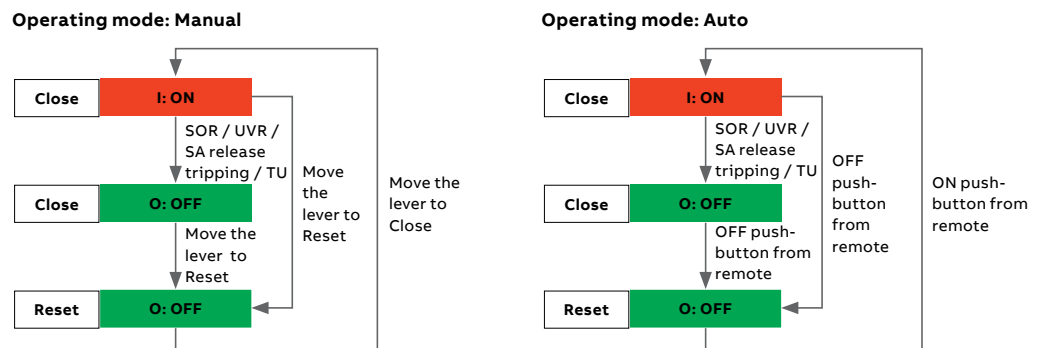

Stored energy motor operators - MOE and MOE-E XT2-XT4



Stored energy motor operators (MOE)

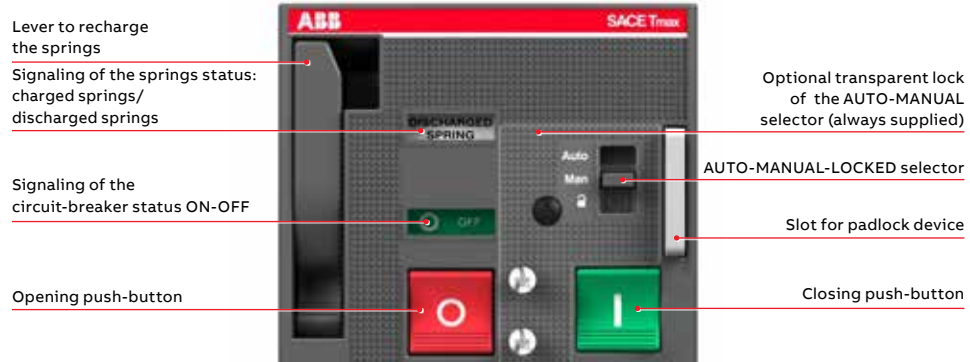

The MOE or MOE-E stored energy motor operator available for XT2 and XT4 is supplied:

- with 3.28 ft long cables;
- with connectors for the fixed part and moving part of withdrawable devices. If the motor operator is used with fixed or plug-in circuit-breakers, the connector can be easily removed;
- with a flange, to be used instead of the standard one supplied with the circuit-breaker;
- with a padlock device, which is only removable when the motor is in the open position. The padlock device accepts up to three 0.3in padlocks;
- with a lock for the AUTO-MANUAL selector;
- with auxiliary contacts (AUX-MO) that allow the motor control mode (manual or remote) signal to be routed outside;
- (on request) the motor operator can be equipped with a key lock (see the Chapter "Accessories" - section "Locks");
- (on request) the motor operator can be equipped with a key lock to safeguard against manual operation (MOL-M) (see the Chapter "Accessories" - section "Locks").

Operating principles:

- a selector on the front of the MOE, is used for selecting the operating mode:
 - AUTO: when the selector is in this position, the push-buttons on the front of the motor are locked. Circuit-breaker closing is commanded remotely only by means of an electric impulse, whereas opening is allowed both remotely and from the front of the motor;
 - MANUAL: the circuit-breaker can only be opened/closed from the front of the motor using the relative push-buttons;
 - LOCKED: when the selector is in this position, the circuit-breaker is in the open position. The padlock device can be withdrawn and the motor can be locked in the open position;
- operation of the motor operator via remote control is also guaranteed by permanent electrical opening/closing impulses. Once an opening command has been given, the next closing command (permanent) is taken over by the motor operator once the opening has been completed. In the same way, an opening command is taken over once the previous closing operation has been completed.

When the Ekip Com module is used, the MOE-E motor operator must be used instead of the MOE motor operator. The MOE-E allows the digital signals from the supervision and monitoring system to be used by means of the release and Ekip Com contacts and to be converted into power signals to command the motor operator. All the features described above for the MOE motor operator are available also on the MOE-E version.

Operating mode: Manual

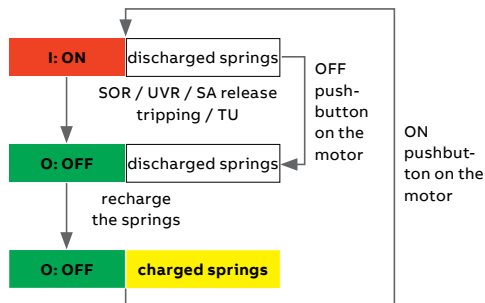

Operating mode: Auto

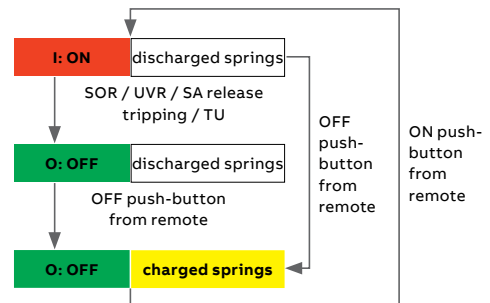

Remote control



Stored energy motor operator (MOE)

Stored energy motor operators - MOE and MOE-E XT5 and MOE XT6

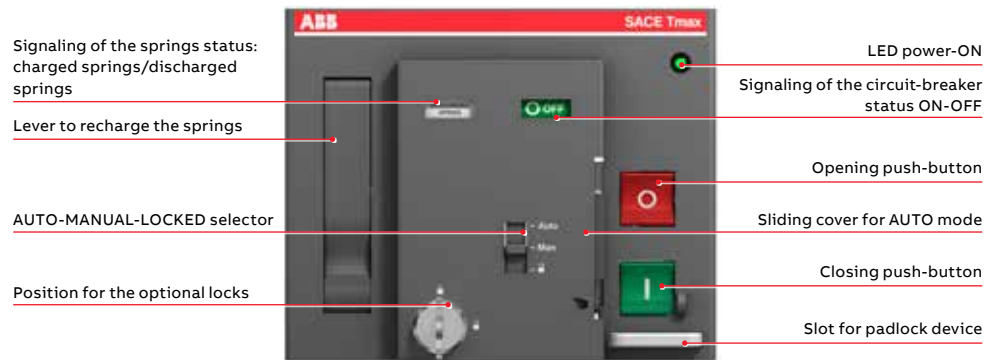

The MOE or MOE-E stored energy motor operator available for the XT5 and XT6 is supplied:

- with 3.28 ft long cables;
- with connectors for the fixed part and moving part of withdrawable devices. If the motor operator is used with fixed or plug-in circuit-breakers, the connector can be easily removed;
- with a flange, to use instead of the standard one supplied with the circuit-breaker;
- with a padlock device, only removable when the motor is in the open position. The padlock device accepts up to three 0.3in padlocks;
- with a lock for the AUTO-MANUAL selector;
- with auxiliary contacts that allow the motor control mode (manual or remote) signal to be routed outside;
- (on request) the motor operator can be equipped with a key lock (see the Chapter "Accessories" - section "Locks");
- (on request) the motor operator can be equipped with a key lock to safeguard against manual operation (MOL-M) (see the Chapter "Accessories" - section "Locks").

Operating principles:

- a selector on the front of the MOE, is used to select the operating mode:
 - AUTO: when the selector is in this position, the push-buttons on the front of the motor are locked and covered by a sliding cover. It is possible to seal the sliding cover to avoid mode changing. Circuit-breaker closing is commanded remotely only by means of an electric impulse, whereas opening is allowed both remotely and from the front of the motor using a tool;
 - MANUAL: the circuit-breaker can only be opened/closed from the front of the motor using the relevant push-buttons. It is possible to seal the sliding cover to avoid mode changing;
 - LOCKED: the device can be used only if the motor is in the open position and the springs are charged. The padlock device can be withdrawn and the can be motor locked in the open position;
- operation of the motor operator via remote control is also guaranteed by permanent electrical opening/closing impulses. Once an opening command has been given, the next closing command (permanent) is taken over by the motor operator once the opening has been completed. In the same way, an opening command is taken over once the previous closing operation has been completed.

When the Ekip Com module is used, the MOE-E motor operator must be used instead of the MOE motor operator. The MOE-E allows digital signals from the supervision and monitoring system to be used by means of the release and Ekip Com contacts and to be converted into power signals to command the motor operator. All the features described above for the MOE motor operator are also available on the MOE-E version.

Operating mode: Manual

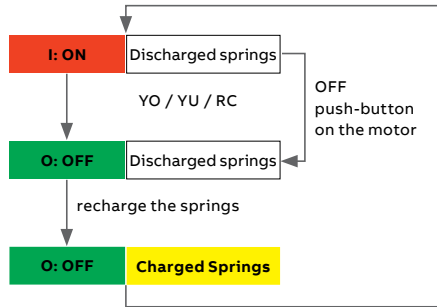

Operating mode: Auto

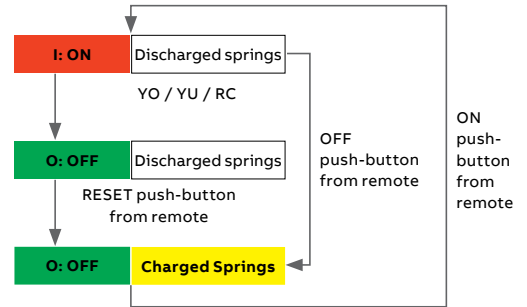

With the XT5 MOE and MOE-E and the XT6 MOE, it is possible to define some reset logic in order to charge the springs automatically once the circuit-breaker has tripped depending on the reset wiring diagram chosen. Three different options are available:

- Auto Reset: the circuit-breaker is automatically reset after a trip (not due to the trip unit) and the springs are charged;
- Remote Reset: it is possible to connect a push-button in order to charge the springs after a trip (not due to the trip unit);
- Manual Reset: charging springs must be done manually after a trip.

As explained in the motor circuit diagram, the auxiliary contact S51 must be properly connected to enable remote or automatic resetting. After a trip due to an overload or a short-circuit (trip unit), only a manual reset is permitted.

Manual Reset

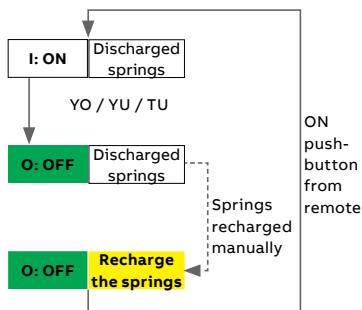

Remote Reset

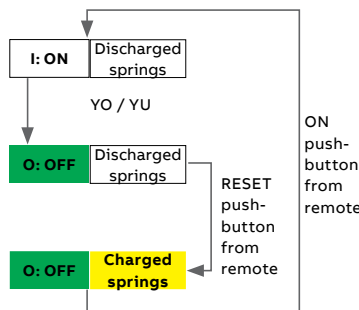

Auto Reset

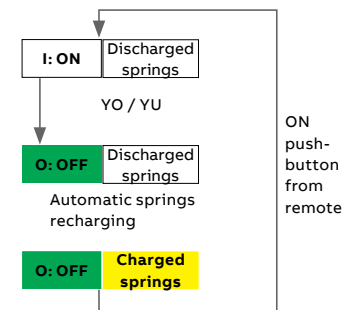

Remote control

Electrical specifications	MOD		MOE and MOE-E		MOE
	XT1 – XT3		XT2 – XT4	XT5	XT6
Rated voltage, Un	[V]	24 DC	24 DC	24 DC	24 DC
	[V]	48...60 DC	48...60 DC	48...60 DC	48...60 DC
	[V]	110...125 AC/DC	110...125 AC/DC	110...125 AC/DC	110...125 AC/DC
	[V]	220...250 AC/DC	220...250 AC/DC	220...250 AC/DC	220...250 AC/DC
	[V]	380...440 AC	380...440 AC	380 AC	380 AC
	[V]	480...525 AC	480...525 AC	-	-
Operating voltage	[% Un]	MIN=85% Un; MAX=110% Un			
Power absorbed on inrush Ps	[VA - W]	≤ 500	≤ 300	≤ 300	≤ 400
Power absorbed on continuing PC service	[VA - W]	≤ 300	≤ 150	≤ 150	≤ 150
Operating frequency	[Hz]	50..60	50..60		
Duration	CL → OP [s]	< 0.1	< 1.5	1.5	3
	OP → CL [s]	< 0.1	< 0.1	< 0.08	< 0.08
	TR → OP [s]	< 0.1	< 3	< 3	< 5
Mechanical life	N° operations	25000	25000	20000	10000
Minimum duration of electrical opening and closing command	[ms]	≥ 150	≥ 150	≥ 100	≥ 100

Motor – M

Available on SACE Tmax XT7 M only, this motor automatically loads the closing springs of the circuit-breaker. The device automatically reloads the springs of the operating device when they are discharged and energized. In the event of a lack of power, the springs can be manually charged by using a dedicated lever on the operating device. The motor of the XT7 M can be equipped with an S33/M contact which signals the status of the springs that must be ordered separately.



Motor operator

Electrical specifications	Motor Operator XT7 M
Rated voltage, Un	[V] 24...30 AC/DC
	[V] 48...60 AC/DC
	[V] 100...130 AC/DC
	[V] 220...250 AC/DC
	[V] 380...415 AC
Operating voltage	[% Un] MIN=85% Un; MAX=110% Un
Power absorbed on inrush Ps	[VA - W] 300
Inrush time	[ms] 200
Power absorbed on continue PC service	[VA - W] 100
Operating frequency	[Hz] 50..60
Charging time	[s] 8

Safety and protection



Terminal covers

Terminal covers

Terminal covers are applied to the circuit-breaker to prevent accidental contact with live parts, thus providing protection against direct contact. The terminal covers are pre-punched to facilitate the installation of busbars and/or cables, guaranteeing the correct insulation. The terminal covers are able to guarantee adequate circuit-breaker installation and correct insulation and are listed in the Chapter “Power Connection”.

There are different types of terminal covers:

- High terminal covers (HTC)
- Low terminal covers (LTC)
- Extended high terminal covers (HTC-ES), for front extended terminals
- High terminal covers with back shield (HTC_BS), with a back plate in order to guarantee insulation with the rear zone of the switchboard

The table below shows the terminal covers available for each frame:

	XT1		XT2		XT3		XT4		XT5		XT6		XT7/XT7 M	
	3p	4p	3p	4p	3p	4p	3p	4p	3p	4p	3p	4p	3p	4p
HTC - High terminal covers	■	■	■	■	■	■	■	■	■	■	■	■	■	■
LTC - Low terminal covers	■	■	■	■	■	■	■	■	■	■	■	■	■	■
HTC-ES - Extended high terminal covers	-	-	-	-	-	-	-	-	■	■	■	■	■	■
HTC_BS - High terminal cover with back shield	-	-	-	-	-	-	-	-	■	■	■	■	■	■
HTC-ES_BS - Extended high terminal covers with back shield	-	-	-	-	-	-	-	-	■	■	■	■	■	■



Phase separators

Phase separators

Phase separators increase the insulation characteristics between phases at the connection level. They are mounted from the front, even when the circuit-breaker has already been installed, by inserting them into the corresponding slots. The phase separators guarantee adequate circuit-breaker installation and correct insulation and are listed in the Chapter “Power connection”.

The following versions of phase separators are available:

- Low phase separators
- Medium phase separators
- High phase separators
- Rear phase separators for fixed part only

	XT1	XT2	XT3	XT4	XT5	XT6	XT7/XT7 M
Phase separator - low	[in] 0.98	0.98	0.98	0.98	0.98	-	-
Phase separator - medium	[in] 3.94	3.94	3.94	3.94	3.94	3.94	3.94
Phase separator - high	[in] 7.87	7.87	7.87	7.87	7.87	7.87	7.87
Rear phase separator for FP	[in] 3.54	3.54	3.54	3.54	3.54	-	-

Sealable screws for terminal covers

The lead sealing kit consists of screws which prevent the removal of the terminal covers, providing protection against direct contacts and tampering. The screws can be locked with wire and lead seals. Each sealing kit consists of two screws. The maximum number of sealable screws that can be used for each circuit-breaker is given in the table below.



Sealable screws

	[No.]	XT1		XT2		XT3		XT4	
		3p	4p	3p	4p	3p	4p	3p	4p
Max number sealable screws for each terminal cover		1	1	1	1	1	2	1	1

Safety and protection



Fixed padlock in open position



Fixed padlock in the open/closed position



Removable padlock in the open position - PLL



Key lock



Padlock in the open position - PLC



Keylock - KLC



Lock to prevent door opening - DLC

Padlocks and key locks

Padlocks or key locks prevent the circuit-breaker from being closed and/or opened. They can be fitted:

- directly on the front of the circuit-breaker;
- on the rotary handle operating mechanism;
- on the front for lever operating mechanism;
- on the motor;
- to the fixed part of withdrawable version, to prevent a moving part from being inserted;
- on the front of the thermal-magnetic trip unit, to prevent the adjuster of the thermal part from being tampered with;
- on the shutters of the fixed part.

In the closed position, the locks do not prevent the mechanism from tripping due to the trip unit or a service release.

Padlocks and keylock for circuit-breaker

Type of lock	Circuit-breaker	Optional/standard supply	Position of circuit-breaker lock	Type of lock	Removability of key	
PLL Fixed padlock device	XT1...XT4	Optional	OPEN/CLOSE	Padlocks max 3 padlocks Ø 0.275 in stem (not supplied)	-	
	XT1...XT4	Optional	OPEN	Padlocks max 3 padlocks Ø 0.275 in stem (not supplied)	-	
	XT5, XT6	Optional	OPEN/CLOSE	Padlocks max 3 padlocks Ø 0.315 in stem (not supplied)	-	
	XT5, XT6	Optional	OPEN	Padlocks max 3 padlocks Ø 0.315 in stem (not supplied)	-	
	XT7 ⁽¹⁾	Optional	OPEN	Padlocks max 3 padlocks Ø 0.315 in stem (not supplied)	-	
PLC Fixed padlock device	XT7 M	Optional	OPEN	Padlocks max 3 padlocks Ø 0.157 in stem (not supplied) Padlocks max 2 padlocks Ø 0.315 in stem (not supplied) Padlocks max 1 padlocks Ø 0.275 in stem (not supplied)	-	
	Circuit-breaker	XT1, XT3	Optional	OPEN	Padlocks max 3 padlocks Ø 0.275 in stem (not supplied)	-
		XT5, XT6	Optional	OPEN	Padlocks max 3 padlocks Ø 0.315 in stem (not supplied)	-
KLC Key lock ⁽²⁾	XT1...XT7	Optional	OPEN	Ronis 1228 Same key (A, B, C, D type)	OPEN	
	XT1...XT7	Optional	OPEN	Ronis 1228 Different key	OPEN	
	XT1...XT7	Optional	OPEN	Ronis 1228 Same key (A, B, C, D type)	OPEN/CLOSE	
	XT7 M	Optional	OPEN	Giussani Same key (20005/6/7/8/9)	OPEN	
	XT7 M	Optional	OPEN	Giussani Different key	OPEN	
KLC Arrangement key lock	XT5...XT6	Optional	OPEN	Kirk, Ronis 1104 and STI key lock	OPEN	
	XT7	Optional	OPEN	Kirk, Ronis 1104, STI and Castell key lock	OPEN	
	XT7 M	Optional	OPEN	Kirk, Ronis 1104, STI and Castell ⁽³⁾ key lock	OPEN	
DLC - Lock to prevent door opening when the circuit-breaker is in the closed position	XT7, XT7 M	Optional	-	This prevents the compartment door from being opened when the circuit-breaker is in the closed position (and with the circuit-breaker racked-in in case of withdrawable circuit-breakers). It also blocks the circuit-breaker from closing when the compartment door is open.	-	

(1) For XT7, the PLL is directly integrated in the plastic cover of the circuit-breaker

(2) For the XT1, XT2, XT3 and XT4, the KLC is incompatible with the electrical accessories mounted on the third pole.

(3) Factory mounted only

Padlocks and keylocks for handles



RHD with key lock



RHE with key lock

Type of lock	Circuit-breaker	Optional/standard supply	Position of circuit-breaker lock	Type of lock	Removability of key
RHL Key lock ⁽¹⁾	XT1...XT7	Optional	OPEN	Ronis 1228 Same key (A, B, C, D type)	OPEN
	XT1...XT7	Optional	OPEN	Ronis 1228 Different key	OPEN
	XT1...XT7	Optional	OPEN	Ronis 1228 Same key (A, B, C, D type)	OPEN/CLOSE
RHL Key lock for panel door with RHE	XT1...XT7	Optional	OPEN	Ronis 1228 Different key	OPEN
Rotary handle (RHD/RHE/RHS)	Padlock device XT1...XT4	standard	OPEN	Padlocks max 3 padlocks Ø 0.236 in stem (not supplied)	-
	Padlock device XT5...XT7	standard	OPEN	Padlocks max 3 padlocks Ø 0.314 in stem (not supplied)	-
Additional padlock device	XT5...XT7	standard with dedicated RH code	OPEN	Padlocks max 3 padlocks Ø 0.314 in stem (not supplied)	-
Door lock ⁽²⁾	XT2, XT4, XT5, XT6	standard	Door locked when CB is closed	-	-

(1) On the transmitted rotary handle (RHE), the lock is mounted on the base. The key lock is not available on the lateral handle (RHS).

(2) When the handle is assembled, this function can be totally inhibited by the customer with a simple operation that can be reversed if needed. Moreover, if the door lock function is not disabled by the customer during the assembly phase, the door lock can be temporarily excluded with a tool in exceptional cases, so that the door can be opened without opening the circuit-breaker.

Padlocks and keylocks for front for the lever operating mechanism



FLD with key lock

Type of lock	Circuit-breaker	Optional/standard supply	Position of circuit-breaker lock	Type of lock	Removability of key
KLC Key lock	XT1...XT6	Optional	OPEN	Ronis 1228 Same key (A, B, C, D type)	OPEN
	XT1...XT6	Optional	OPEN	Ronis 1228 Different key	OPEN
	XT1...XT6	Optional	OPEN	Ronis 1228 Same key (A, B, C, D type)	OPEN/CLOSE
Front for the lever operating mechanism (FLD)	Padlock device XT1...XT4	standard	OPEN	Padlocks max 3 padlocks Ø 0.236 in stem (not supplied)	-
	Padlock device XT5...XT6	standard	OPEN	Padlocks max 3 padlocks Ø 0.314 in stem (not supplied)	-
Door lock	XT2, XT4, XT5, XT6	standard	Door locked when CB is closed	-	-

Safety and protection

Padlocks and keylocks for motors



—
MOD with key lock



—
MOE with key lock



—
Key lock/padlock for withdrawable fixed part



—
Withdrawable fixed part with key lock/padlock



—
Padlock in racked-in/
test/racked-out
position - PLP

Type of lock	Circuit-breaker	Optional/standard supply	Position of circuit-breaker lock	Type of lock	Removability of key	
Motor (MOD, MOE, MOE-E)	Key lock on motor MOL-D	XT1...XT6	Optional	OPEN	Ronis 1228 Same key (A, B, C, D type)	OPEN
	MOL-S	XT1...XT6	Optional	OPEN	Ronis 1228 Different key	OPEN
	Key lock against manual operation MOL-M ⁽¹⁾	XT2-XT4-XT5-XT6	Optional	MANUAL	Ronis 1228 Different key	WITH LOCK INSERTED
	Padlock device	XT1...XT6	standard	OPEN	Padlocks max 3 padlocks Ø 0.314 in stem (not supplied)	-

(1) For MOE and MOE-E only.

Padlocks and keylocks for fixed parts

Type of lock	Circuit-breaker	Optional/standard supply	Position of circuit-breaker lock	Type of lock	Removability of key
KLF-FP Key lock / padlock for fixed part of withdrawable device ⁽¹⁾	XT2, XT4, XT5, XT6	Optional	Key WITHDRAWN/INSERTED/TEST (if available)	Ronis key 1228 Different + padlocks max 3 padlocks Ø 0.236 in stem (not supplied)	-
			Padlock WITHDRAWN		
	XT2, XT4, XT5, XT6	Optional	Key WITHDRAWN/INSERTED/TEST (if available)	Ronis key 1228 Same + padlocks max 3 padlocks Ø 0.236 in stem (not supplied)	-
			Padlock WITHDRAWN		
XT2, XT4	Optional	Key WITHDRAWN/INSERTED	Giussani key Different + padlocks max 3 padlocks Ø 0.236 in stem (not supplied)	-	
		Padlock WITHDRAWN			
XT2, XT4	Optional	Key WITHDRAWN/INSERTED	Giussani key Same + padlocks max 3 padlocks Ø 0.236 in stem (not supplied)	-	
		Padlock WITHDRAWN			
XT5, XT6	Optional	Key WITHDRAWN/INSERTED/TEST (if available)	Arrangement for STI, Ronis 1104 key + padlocks max 3 padlocks Ø 0.236 in stem (not supplied)	-	
		Padlock WITHDRAWN			
KLP Key lock in racked-in/racked-out position - KLP	XT7, XT7 M	Optional	Key WITHDRAWN/INSERTED/TEST	Giussani Same key (20005/6/7/8/9)	-
	XT7, XT7 M	Optional	Key WITHDRAWN/INSERTED/TEST	Giussani Different key	-
Arrangement KLP Key lock in racked-in/racked-out position - KLP	XT7, XT7 M	Optional	Key WITHDRAWN/INSERTED/TEST	Kirk, Ronis 1104, STI and Castell key lock	-
PLP Padlock in racked-in / test / racked-out position	XT7, XT7 M	Optional	Key WITHDRAWN / INSERTED / TEST	Padlocks max 3 padlocks Ø 314 in stem (not supplied)	-

(1) For the XT5 and XT6 this lock/padlock cannot be used with rear mechanical interlock

Lock for thermal regulation

Type of lock	Circuit-breaker	Optional/standard supply	Position of circuit-breaker lock	Type of lock	Removability of key
Trip Unit	Lock for thermal regulation ⁽¹⁾	XT1, XT3	Optional	-	-
		XT2, XT4, XT5, XT6	standard	-	-

(1) This is applied to the cover of the circuit-breakers on level with the regulator of the thermal element of the thermal-magnetic release TMD and prevents it from being tampered with.

Lock for shutters of fixed parts

Type of lock	Circuit-breaker	Optional/standard supply	Position of circuit-breaker lock	Type of lock	Removability of key
Fixed Part	Shutter lock - SL	XT7, XT7 M	Optional	Padlocks max 3 padlocks Ø 8mm stem (not supplied)	-

IP Protection Kit

In order to improve the IP protection degree, some additional kits can be used.

IP54 Protection flange for direct rotary handle (RHD)

This flange can be mounted with the direct rotary handle of the XT5, XT6 and XT7 to guarantee an IP54 degree of protection.

With this flange is not possible to open the panel door when the circuit-breaker is in the closed position.

IP54 Protection for transmitted rotary handle (RHE)

This device can be fixed onto the transmitted rotary and lateral handle of the XT1, XT2, XT3 and XT4 allowing an IP54 degree of protection to be achieved. The IP degree of the transmitted rotary handle for the XT5, XT6 and XT7 is IP65 as standard without an additional accessory.



IP54 protection

IP54 Protection flange for the MOE and XT7 M

This transparent cover completely protects the front of the circuit-breaker, guaranteeing an IP54 degree of protection. This accessory is provided with a double key lock (same or different keys).

This cover is available for the XT5 MOE/MOE-E, XT6 MOE and for the XT7 M circuit-breaker.



IP54 protection for XT7 M

Safety and protection



— Protection device for opening and closing pushbuttons - PBC

Protection device for opening and closing pushbuttons - PBC

This accessory is applied to the safety cover of the XT7 M and is available in two versions.

The push-button protection device blocks the operations on both the opening and closing push-buttons unless a special key is used.

The padlockable push-button protection device makes it possible to block either or both push-buttons and to lock the covers in place. It does not trip the breaker as a standard "Padlock device" would. The protection device for opening and closing push-buttons is an alternative to PLC padlocks.



— Mechanical operation counter - MOC

Mechanical operation counter - MOC

The mechanical operation counter is available on the Tmax XT7 M only. This mechanical operation counter is visible on the front of the circuit-breaker and allows the user to see how many mechanical operations the device has performed.



— Circuit-breaker with optional flange

Flange

This is a plastic plate that acts as an interface between the circuit-breaker and the hole in the panel door. All the Tmax XT flanges are newly designed and do not require screws for installation. The flanges can be applied:

- around the front part of the fixed/plug-in circuit-breaker;
- around the operating lever for all fixed/plug-in/withdrawable version circuit-breakers;
- around the MOD or MOE motor operator;
- around the front of FLD locks;
- around the direct rotary handle operating mechanism;
- around the RC Inst, RC Sel for the XT1 and XT3, and around the RC Sel for the XT2, XT4 and XT5.



— Rotary handle with flange



— MOE with flange



— XT1-XT3 circuit-breaker with standard flange



— XT7 and XT7 M flanges



— MOD with flange



— XT2-XT4 circuit-breaker with standard flange

Interlocks and switching devices

Operating mechanism		XT1	XT2	XT3	XT4	XT5	XT6	XT7	XT7 M
Rear mechanical interlock	MIR Horizontal	■	■	■	■	■	■	-	-
	MIR Vertical	■	■	■	■	■	■	-	-
Cables interlocks	Type A (2 CBs)	-	-	-	-	-	-	■	■
	Type B, C and D (3 CBs)	-	-	-	-	-	-	■	■
Automatic transfer switch	ATS021	■	■	■	■	■	■	■	■
	ATS022	■	■	■	■	■	■	■	■



Interlock

Rear mechanical interlock

This is a support designed for installation on the rear of two circuit-breakers to be interlocked. It prevents the two circuit-breakers on which it is installed from closing simultaneously by linking components. Tmax XT circuit-breakers can be interlocked two-by-two (IO-OI-OO) by means of a chassis and special plates. Interlocked circuit-breakers can be in fixed, plug-in or withdrawable versions. Both circuit-breakers and switch-disconnectors in the 3 and 4 pole versions can be interlocked.

The allowed combinations are:

	XT1	XT2	XT3	XT4	XT5	XT6
XT1	■	■	■	■		
XT2	■	■	■	■		
XT3	■	■	■	■		
XT4	■	■	■	■	■	
XT5				■	■	■
XT6					■	■

The following equipment must be ordered to make a rear interlock:

- a vertical or horizontal chassis;
- a plate for each circuit-breaker to be interlocked.

For using an XT4 on an XT5 chassis and an XT5 on an XT6 chassis, dedicated plates are necessary.

Please note that remote closing commands sent to interlocked circuit-breakers in the open position must be prevented in order to ensure the correct functioning of the mechanical interlock. If this is not possible, key locks in the open position for the MOE are necessary.

With the XT5 and XT6 interlock chassis, for withdrawable version circuit-breakers, the use of the key-lock/ padlock for fixed parts (KLF) is not allowed.

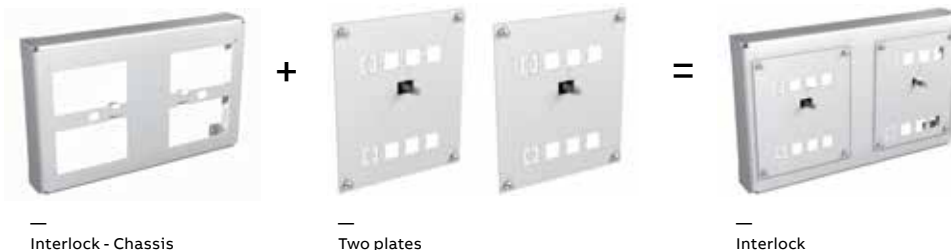

Interlock - Chassis

Two plates

Interlock

Interlocks and switching devices

Cables interlocks

These interlock systems, for the Tmax XT7 and XT7 M, enable various opening and closing configurations to be obtained between two or three circuit-breakers. Four types of interlock configuration are available:

Type A

Excludes the possibility of having two circuit-breakers in the closed position at the same time.

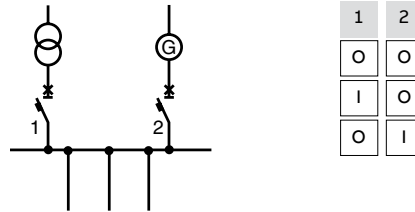

Type B

Permits a pair of circuit-breakers to be closed if the third is open. The latter can only be closed when the paired circuit-breakers are open.

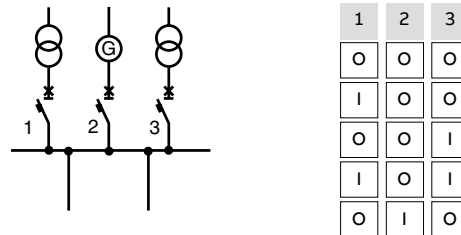

Type C

Permits two out of three circuit-breakers to be closed at the same time.

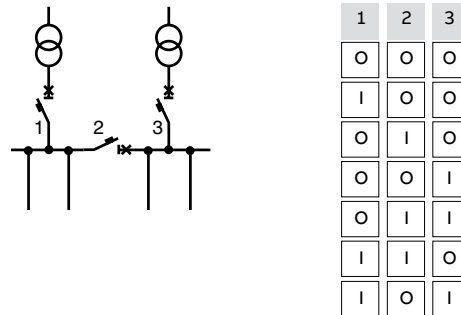

Type D

Permits one out of three interlocked circuit-breakers to be closed.

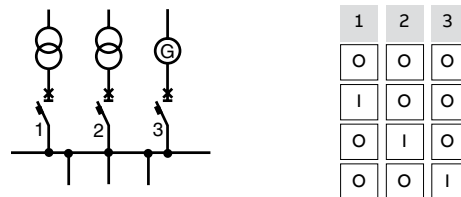

—
ATS021—
ATS022

Automatic network-generator transfer unit ATS021-ATS022⁽¹⁾

The ATS (Automatic Transfer Switch) is a network-generator transfer unit used in installations where switching the main power line to an emergency line is required to ensure power supply to the loads in case of anomalies in the main line.

The unit is able to manage the entire transfer procedure automatically and prepares the commands for carrying out the procedure manually as well.

In the case of an anomaly in the main line voltage, in accordance with parameters set by the user, the opening of the circuit-breaker of the main line, the starting of the generator set (when provided) and the closing of the emergency line can be carried out. In the same way, when the line is supplied back, the procedure of reverse transfer is controlled automatically.

The new generation of the ATS (ATS021 and ATS022) offers the most advanced and complete solutions to guarantee service continuity. The ATS021 and ATS022 can be used with all the circuit-breakers as well as the molded case switches of the SACE Tmax XT family. The ATS021 and ATS022 devices have been designed to operate with a self-supply. The ATS022 unit also prepares the connection for the auxiliary power supply, which allows additional functions to be used.

The ATS021 and ATS022 devices carry out the control of both the power supply lines and analyze:

- phase unbalance;
- frequency unbalance;
- phase loss.

Apart from the standard control functions, the ATS022 enables the following operations:

- selection of the priority line;
- control of a third circuit-breaker;
- integration of the device in a supervision system with Modbus communication (an auxiliary power supply is needed);

Typical applications include: power supply to UPS (Uninterrupted Power Supply) units, operating theaters and primary hospital services, emergency power supplies for civil buildings, airports, hotels, data banks and telecommunication systems, and the power supply of industrial lines for continuous processes.

For the correct configuration, each circuit-breaker connected to the ATS021 or ATS022 must be fitted with the following accessories:

- a mechanical interlock;
- a motorized control for opening and closing;
- a key lock against manual operation for the motor operator;
- a signaling contact for the status (open/closed) and a signaling contact for tripping;
- a contact for the racked-in position (in the case of a withdrawable version circuit-breaker).

(1) Devices described in this section (ATS) are not UL listed.

Interlocks and switching devices

	ATS021	ATS022
General		
Auxiliary Power Supply	Not Required	Not Required (24-110V DC is required only for Modbus dialogue and 16 2/3 Hz system)
Rated Voltage, Un [VAC]	Max 480	Max 480
Frequency [Hz]	50, 60	16 2/3, 50, 60, 400
Dimensions (HxLxD) [in]	3.78x5.67x6.69	3.78x5.67x6.69
Type of installation	Door mounting DIN-rail mounting	Door mounting DIN-rail mounting
Operating Mode	Auto/Manual	Auto/Manual
Features		
Monitoring of the Normal and Emergency lines	■	■
Controlling CBs of the Normal and Emergency lines	■	■
Generator set start-up	■	■
Generator set shutdown with adjustable delay	■	■
Bus-tie	-	■
No-priority Line	-	■
Modbus RS485	-	■
Display	-	■
Ambient conditions		
Operating temperature	-20...+60 °C	-20...+60 °C
Humidity	5% - 90% without condensation	5% - 90% without condensation
Operating thresholds		
Minimum voltage	-30%...-5%Un	-30%...-5%Un
Maximum voltage	+5%...+30%Un	+5%...+30%Un
Fixed frequency thresholds	-10%...+10%fn	-10%...+10%fn
Test		
Test Mode	■	■
Compliance with standards		
Electronic equipment for power installations	EN-IEC 50178	EN-IEC 50178
Electromagnetic compatibility	EN 50081-2	EN 50081-2
	EN 50082-2	EN 50082-2
Environmental conditions	IEC 60068-2-1	IEC 60068-2-1
	IEC 60068-2-2	IEC 60068-2-2
	IEC 60068-2-3	IEC 60068-2-3

Residual current protection according to IEC 60947-2 Annex B ⁽¹⁾

Residual current release

Both circuit-breakers and molded case switches are pre-engineered for assembly combined with residual current releases.

Residual current circuit-breakers derived from the circuit-breaker are known as “mixed”, meaning that, besides protection against the typical overloads and short-circuits, they also provide protection for people and against earth fault currents, thus protecting against direct, indirect contacts and risk of fire. Residual current circuit-breakers derived from molded case switches are “pure” residual current circuit-breakers, i.e. they only provide residual current protection and not the protection typical of circuit-breakers. “Pure” residual current circuit-breakers are only sensitive to earth fault currents and are generally used as main switches in small panels for distribution to end users.

Use of “pure” and “mixed” residual current circuit-breakers allows the insulation state of the installation to be continuously monitored. It ensures efficient protection against the risk of fire and explosions and also protects people against indirect and direct contacts, thereby integrating the compulsory measures established by the accident prevention Standards and Regulations.

The residual current releases comply with the following Standards:

- IEC 60947-2 Annex B;
- IEC 61000 for protection against unwanted tripping.

The table below gives all the residual current devices that can be used in combination with SACE Tmax XT family:

		XT1		XT2		XT3		XT4		XT5	
		3p	4p	3p	4p	3p	4p	3p	4p	3p	4p
Instantaneous residual current device	RC Inst	F	F			F	F				
Selective residual current device	RC Sel XT1-XT3	F	F			F	F				
	RC Sel 200		F								
	RC Sel XT2-XT4					F-P-W				F-P-W	
	RC Sel XT5										F-P-W
Type B residual current device	RC Type B XT3						F				

Tmax XT residual current devices:

- are designed for XT1, XT2, XT3 and XT4 microprocessor technology and act directly on the circuit-breaker by means of a dedicated opening solenoid (supplied with the residual current release and also available as a spare part) which must be housed in the relevant slot formed in the third pole on the left of the operating lever;
- are designed for XT5 feature microprocessor technology and act directly on the circuit-breaker by means of a dedicated mechanism integrated in the residual current itself;
- do not need an auxiliary supply as they are powered directly from the mains;
- can be supplied either from above or below;
- provide guaranteed functionality even with a single phase plus neutral or just two live phases and in the presence of pulsating unidirectional currents with direct components (minimum auxiliary voltage PHASE-NEUTRAL 85 Vrms);
- permit all possible connection combinations, as long as the neutral connection to the first pole on the left in the four-pole version is guaranteed.

(1) All the devices described in this section are not UL listed

Residual current protection

RC Sel residual current releases (type A) XT1

Thanks to its low height, the RC Sel 200 residual current release can be installed in 7.87in modules.

Moreover, its special shape reduces the overall size of the installation if two or more units are installed side by side.

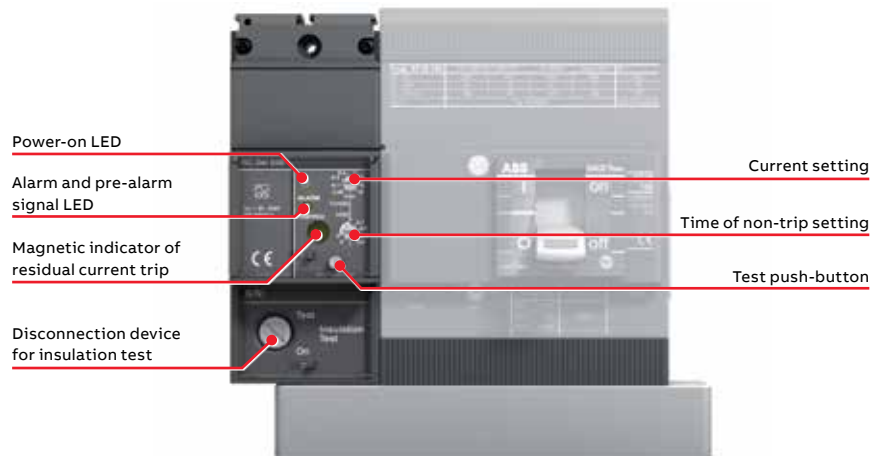

RC Inst residual current releases for XT1 and XT3

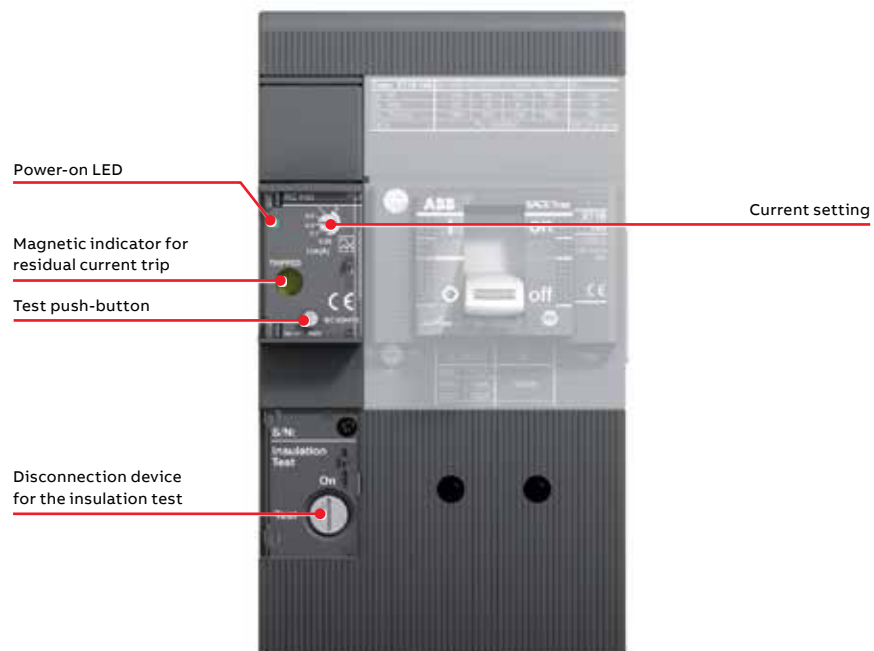

RC Sel current releases (type A) for XT1 and XT3

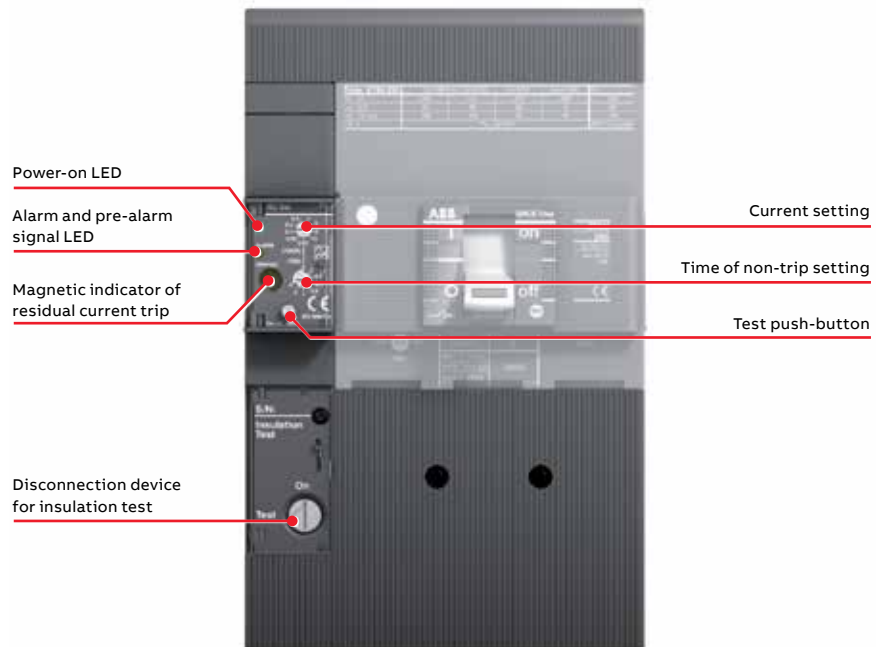

With the RC Inst and RC Sel residual current releases for the XT1 - XT3 available in fixed versions only, it is possible to make rear terminal connections by ordering the RC Rear terminal 4p kits.

RC Sel residual current releases for XT2 and XT4

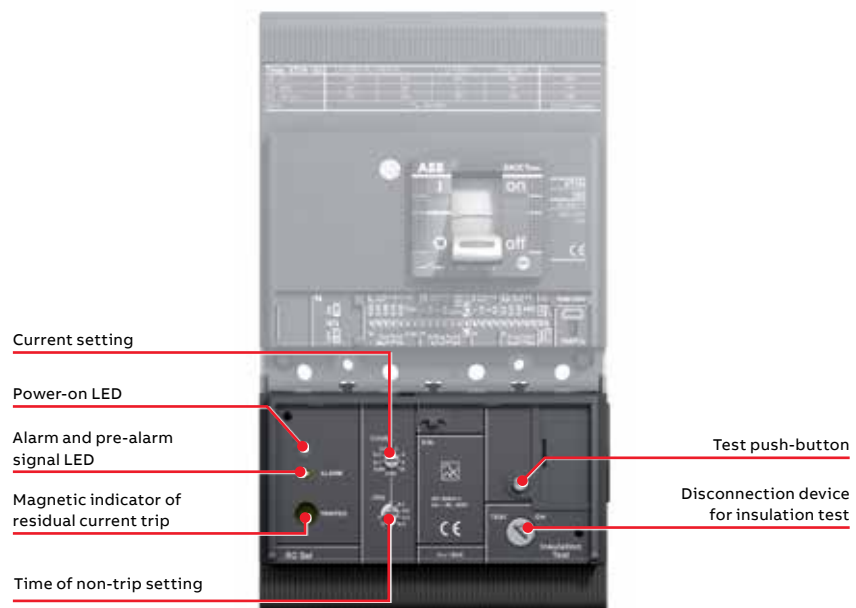

Residual current protection

The fixed version of the RC Sel residual current release can be easily converted:

- into a plug-in type of release:
 - by ordering the kit for converting the residual current release from the fixed to the plug-in version
- into a withdrawable type of release:
 - by ordering the kit for converting the residual current release from the plug-in to the withdrawable version. This kit contains the shunt opening release of the withdrawable residual current device to replace the shunt opening release supplied with the fixed version. The shunt opening release of the withdrawable residual current device contains both the connector for the moving part and the connector for the fixed part.

With the RC Sel residual current release for the XT2-XT4, it is possible to use the same terminals for the fixed circuit-breaker and for the fixed parts of the plug-in and withdrawable circuit-breakers.

With the withdrawable and plug-in versions, frame 160A with RC can be used up to a maximum current of 135A, whereas frame 250A can be used up to 210A.

RC Sel current releases (type A) for XT5

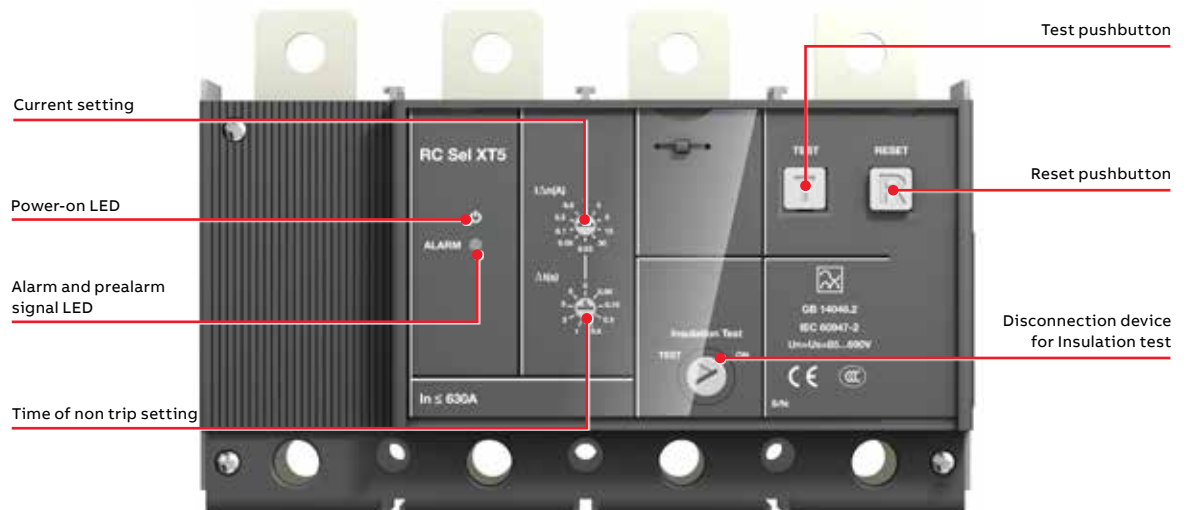

The fixed version of the RC Sel residual current release can easily be converted:

- into a plug-in type of release:
 - by ordering the kit for converting the residual current release from the fixed to the plug-in version into a withdrawable type of release:
- by ordering the kit for converting the residual current release from the plug-in to the withdrawable version. This kit contains the shunt opening release of the withdrawable residual current device to replace the shunt opening release supplied with the fixed version. The shunt opening release of the withdrawable residual current device contains both the connector for the moving part and the connector for the fixed part.

With the RC Sel residual current release for the XT5, it is possible to use the same terminals for the fixed circuit-breaker and for the fixed parts of the plug-in and withdrawable circuit-breakers.

RC Sel for XT5 is always a four poles version that can be mounted also on a three-pole circuit breakers using the dedicated cover supplied in the RC kit.

RC B Type residual current releases (type B) for XT3

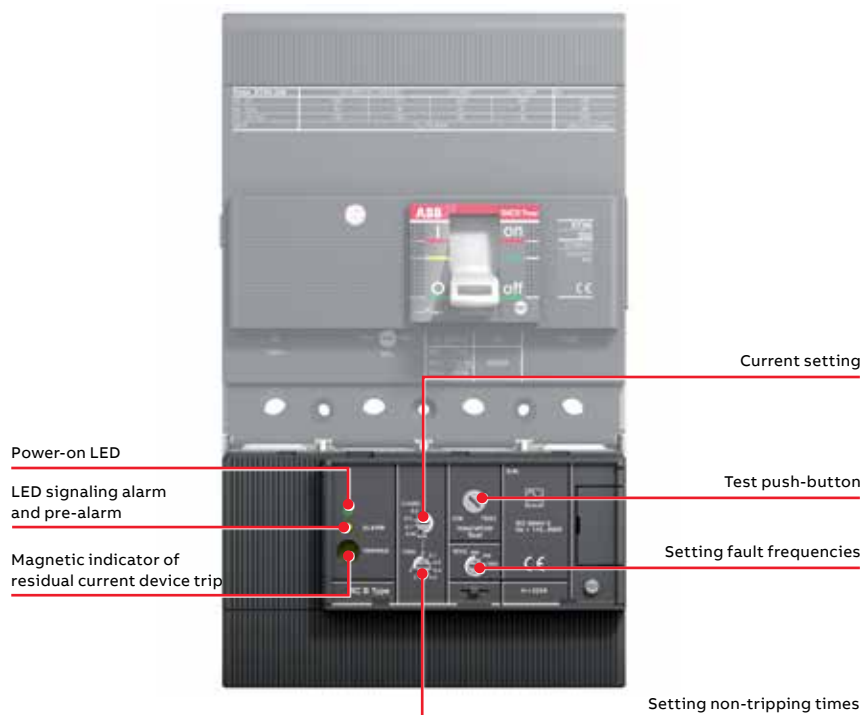

The RC residual current release type B, to be used in conjunction with the XT3 circuit-breaker, has the following features:

- it complies with type B operation, which guarantees sensitivity to residual fault currents with alternating, pulsating alternating and direct current components (in compliance with the Standards 60947-1, IEC 60947-2 Annex B, IEC/TR 60755);
- the maximum frequency band of the residual fault current detection can be selected (3 steps: 400 - 700 - 1000Hz). The residual current device can therefore be adapted to suit various industrial installation requirements according to the prospective fault frequencies generated on the load side of the release. Typical installations that may require different frequency thresholds from the standard ones (50 - 60Hz) include welding systems for the automobile industry (1000Hz), the textile industry (700Hz), airports and three-phase drives (400Hz).

Residual current protection

Electrical characteristics	Residual current devices				
	RC Sel 200 XT1	RC Inst XT1-XT3	RC Sel XT1-XT3	RC Sel XT2-XT4	RC Sel XT5 ⁽³⁾
Primary power supply voltage [V]	85...690	85...690	85...690	85...690	85...500
Operating frequency [Hz]	45...66	45...66	45...66	45...66	45...66
Fault frequency [Hz]	50-60	50-60	50-60	50-60	50-60
Test operating range [V]	85...690	85...690	85...690	85...690	85...500
Rated operating current [A]	up to 160	XT1 up to 160 XT3 up to 250	up to 160 XT1 up to 250 XT3	up to 160 XT2 ⁽²⁾ up to 250 XT4 ⁽²⁾	up to 550A ⁽²⁾
Adjustable trip thresholds [A]	0.03-0.05-0.1- 0.3-0.5-1-3-5-10	0.03-0.1-0.3 0.5-1-3	0.03-0.05-0.1- 0.3-0.5-1-3-5-10	0.03-0.05-0.1- 0.3-0.5-1-3-5-10	0.03-0.05-0.1-0.3 0.5-1-3-5-10-30
Selective type S	■	-	■	■	■
Adjustable NON-trip time settings [s] at 2xI Δ n	Instantaneous 0.1-0.2-0.3- 0.5-1-2-3	Instantaneous	Instantaneous 0.1-0.2-0.3- 0.5-1-2-3	Instantaneous 0.1-0.2-0.3- 0.5-1-2-3	Instantaneous 0.06-0.15-0.3- 0.5-1-2-3-5
Power input	<5 W at 690V AC	<5 W at 690V AC	<5 W at 690V AC	<5 W at 690V AC	<5 W at 500V AC
Trip Coil with switch contact for trip signal	■	■	■	■	■
Input for remote controlled opening command	■	-	■	■	■
NO contact for pre-alarm signal	■	-	■	■	■
NO contact for alarm signal	■	-	■	■	■
Pre-alarm indication from 25% I Δ n. Steady yellow LED light	■	-	■	■	■
Alarm timing indication at 75% I Δ n. Flashing yellow LED light ⁽¹⁾	■	-	■	■	■
Type A for pulsating alternating current Type AC for alternating current	■	■	■	■	■

(1) Indication of alarm timing at 90% I Δ n for 30mA for XT1, XT2, XT3 and XT4. Indication of alarm timing at 75%I Δ n for 30mA for XT5

(2) Plug-in and withdrawable version: the 160 frame can be used with a max I n = 135A
the 250 frame can be used with a max I n = 210A
the 630 frame can be used with a max I n = 500A

(3) Only for IEC circuit-breakers with Icu up to 100ka @415V (N-S-H-L versions)

Electrical characteristics	Residual current devices
	RC B Type XT3
Primary power supply voltage [V]	110...500
Operating frequency [Hz]	45...66
Fault frequency [Hz]	400-700-1000
Test operating range [V]	110...500
Rated operating current [A]	up to 225
Adjustable trip thresholds [A]	0.03-0.05-0.1-0.3-0.5-1
Selective type S	■
Adjustable NON-trip time settings [s] at $2 \times I_{\Delta n}$	Instantaneous 0-0.1-0.2-0.3-0.5-1-2-3
Power input	<10 W at 500V AC
Trip Coil with switch contact for trip signal	■
Input for remote controlled opening command	■
NO contact for pre-alarm signal	■
NO contact for alarm signal	■
Steady yellow LED light	■
Flashing yellow LED light ⁽¹⁾	■
Type A for pulsating alternating current, Type AC for alternating current	■
Type B for pulsating current and direct current	■

(1) Indication of alarm timing at 90% $I_{\Delta n}$ for 30mA

Residual current protection

SACE RCQ020 panel type residual current release

SACE Tmax XT circuit-breakers can also be used in conjunction with RCQ020 panel type residual current releases with a separate toroid to be installed on the line conductors (“/A” indicates the necessity for an auxiliary power supply).

Thanks to its wide range of settings, the panel release is suitable for:

- applications where the installation conditions are particularly restrictive, such as for circuit-breakers that are already installed or where there is limited space in a compartment where the circuit-breaker is installed;
- creating a residual current protection system coordinated at various distribution levels, from the main switchboard to the end user;
- where residual current protection with low sensitivity is required, e.g. in partial (current) or total (time) selective chains;
- highly sensitive applications (physiological sensitivity) for protecting people against direct contacts.

Thanks to the 115-230...415V external auxiliary power supply, the RCQ020 panel type residual current device is able to detect current leakages from 30mA to 30A and to act with a trip time that can be adjusted from instantaneous to a delay of 5s. The opening mechanism is an indirect action type and acts on the circuit-breaker release mechanism by means of the shunt opening or an undervoltage release of the circuit-breaker itself.

The opening command to the circuit-breaker (trip delay) can be temporarily inhibited, and the circuit-breaker can be opened by remote control by means of the RCQ020 device.

The following equipment must be requested when ordering:

- the RCQ020 device itself;
- an opening coil (SOR) or an undervoltage release (UVR) of the circuit-breaker to be housed in the relative slot made in the left pole of the circuit-breaker itself;
- a closed toroid, which can be used for both cables and busbars, with a diameter from 60mm to 185mm.

Signals available:

- LED to indicate the status of the residual current device (supplied or not supplied). The RCQ020 is equipped with a positive safety function thanks to which the RCQ020 sends an automatic circuit-breaker opening command in the absence of auxiliary voltage;
- LED for fault signaling;
- LED for signaling tripping of the residual current device;
- electrical pre-alarm/alarm/trip signals.

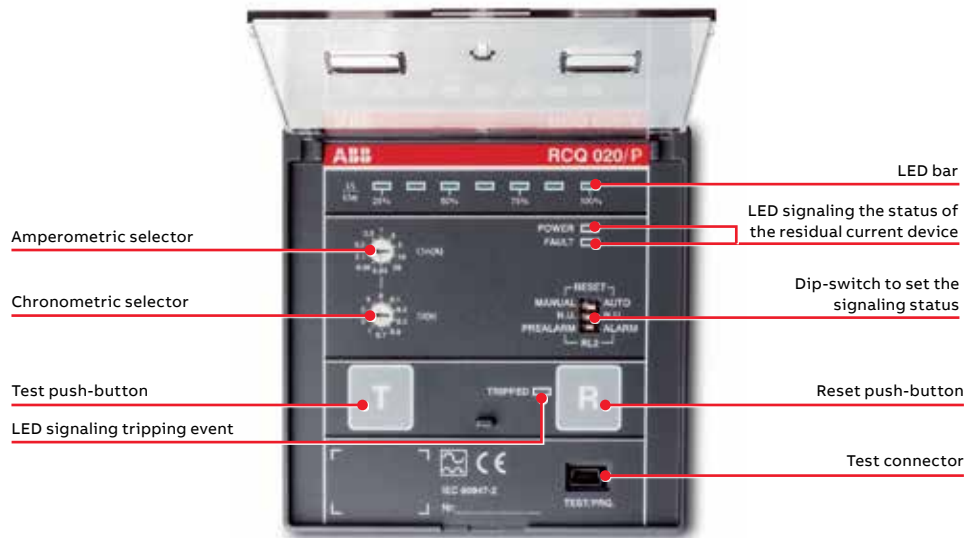

Residual current protection

Power supply Voltage	/A	AC [V]	115-230...415
	/P	AC [V]	110...690
	/P	DC [V]	110...125
Operating frequency		[Hz]	45÷66
Inrush current	/A	@115 V AC	500 mA for 50 ms
	/A	@230 V AC	150 mA for 50 ms
	/A	@415 V AC	100 mA for 50 ms
	/P	@110 V AC	300 mA for 50 ms
	/P	@690 V AC	2 A for 50 ms
	/P	@125 V DC	500 mA for 50 ms
Rated Power	/A		2 [VA] / 2 [W]
	/P	@115 V AC	max 3 W
	/P	@230 V AC	max 3 W
	/P	@690 V AC	max 4 W
	/P	@125 V DC	max 2 W
Trip threshold adjustment I Δ n		[A]	0.03-0.05-0.1-0.3-0.5-1-3-5-10-30
No trip time adjustment		[s]	instantaneous 0.1-0.2-0.3-0.5-0.7-1-2-3-5
Pre-alarm threshold		x I Δ n	25%
A type for pulsing alternate current			■
Signals			
Device powered visual signaling			■
Visual signaling of device not functioning / not configured			■
Visual signaling of residual current protection			■
Electrical alarm/pre-alarm signal			■
Electric trip signal			■
Controls			
Remotely controlled opening command			■
Remotely controlled reset command			■
Operating range of closed transformers			
Ø 2.36 [in] toroidal transformer		[A]	In max = 250 A - Use 0.03...30 A
Ø 4.33 [in] toroidal transformer		[A]	In max = 400 A - Use 0.03...30 A
Ø 7.28 [in] toroidal transformer		[A]	In max = 800 A - Use 0.1...30 A
Connection to toroidal transformer			By means of 4 shielded or twisted conductors. Maximum tolerated length: 50 ft
Dimensions W x H x D		[mm/in]	[96x96x77] / [3.77x3.77x3]
Drilling for assembly on door standard		[mm/in]	[92x92] / [6.62x3.62]
			IEC 60947-2 annex M

Compatibility of accessories

Fixed and plug-in versions

Check whether the different devices are compatible/incompatible with each other when ordering accessories. The following table provides a simple check of the compatibility between mechanical and electrical accessories. To understand the abbreviations used to identify the accessories more easily, refer to the "Glossary" at the end of the section.

How to read compatibility tables - an example



Three-pole circuit-breaker

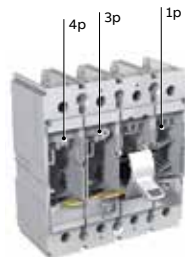

Four-pole circuit-breaker

Fixed/plug-in circuit-breaker compatibility XT1-XT3						
	SOR 3p	UVR 3p	3Q 3p	SOR 4p	UVR 4p
SOR 3p	↑	↑	↑	✓	✓	
UVR 3p ¹	→	→	→	✓	✓	
3Q sx 3p				✓	✓	
SOR 4p	✓	✓	✓		✓	
UVR 4p	✓	✓	✓	✓ [...]		
[...]						

The UVR positioned in the slot of the 3rd pole⁽¹⁾ is:

- incompatible with the SOR positioned on the 3rd pole⁽²⁾;
- incompatible with the UVR positioned on the 3rd pole⁽³⁾;
- incompatible with the 3Q contacts on the left of the 3rd pole⁽⁴⁾;
- compatible with the SOR positioned in the slot of the 4th pole⁽⁵⁾;
- compatible with the UVR positioned in the slot of the 4th pole⁽⁶⁾.
- [...]

Tmax XT1-XT3

	RHD	RHE	RHS	FLD	MOD	PLL on CB	KLC on CB	RHL	MOL on motor	SOR/UVR 3p	3Q left 3p	RC Coil 3p	SOR/UVR 4p	3Q left 4p	1Q+1SY	2Q+1SY	3Q+1SY	AUE
RHD								✓		✓	✓	✓	✓	✓	✓	✓	✓	✓
RHE								✓		✓	✓	✓	✓	✓	✓	✓	✓	✓
RHS										✓	✓	✓	✓	✓	✓	✓	✓	✓
FLD								✓		✓	✓	✓	✓	✓	✓	✓	✓	✓
MOD									✓	✓	✓	✓	✓	✓	✓	✓	✓ ⁽¹⁾	✓ ⁽²⁾
PLL on CB										✓	✓	✓	✓	✓	✓	✓	✓	✓
KLC on CB													✓	✓	✓	✓	✓	✓
RHL	✓	✓		✓						✓	✓	✓	✓	✓	✓	✓	✓	✓
MOL on motor					✓					✓	✓		✓	✓	✓	✓	✓	✓
SOR/UVR 3p	✓	✓	✓	✓	✓	✓		✓	✓				✓	✓	✓	✓	✓	✓
3Q left 3p	✓	✓	✓	✓	✓	✓		✓	✓				✓	✓	✓	✓	✓	✓
RC Coil 3p	✓	✓	✓	✓	✓	✓		✓					✓	✓	✓	✓	✓	✓
SOR/UVR 4p	✓	✓	✓	✓	✓	✓	✓	✓	✓	✓	✓	✓		✓	✓	✓	✓	✓
3Q left 4p	✓	✓	✓	✓	✓	✓	✓	✓	✓	✓	✓	✓		✓	✓	✓	✓	✓
1Q+1SY	✓	✓	✓	✓	✓	✓	✓	✓	✓	✓	✓	✓	✓	✓				✓
2Q+1SY	✓	✓	✓	✓	✓	✓	✓	✓	✓	✓	✓	✓	✓	✓				✓
3Q+1SY	✓	✓	✓	✓	✓ ⁽²⁾	✓	✓	✓	✓	✓	✓	✓	✓	✓				✓
AUE	✓	✓						✓	✓	✓	✓	✓	✓	✓	✓	✓	✓	✓

✓ Compatible; (1) Not valid for XT1; (2) Not valid for XT3

Compatibility of accessories

Tmax XT2-XT4

Circuit-breakers with thermal-magnetic or electronic Ekip Dip trip units

	RHD	RHE	RHS	FLD	MOE/MOE-E	PLL on CB	KLC on CB	RHL	MOL on motor	SOR/UVR 3p	3Q left 3p	RC Coil 3p	SOR/UVR 4p	3Q left 4p	1Q+1SY	2Q+1SY	3Q+1SY	3Q+2SY	2Q+2SY+1S51	1S51	400V 2Q	400V 1Q+1SY	AUE	Ekip COM STA RTU / Ekip COM LSI-LSIG ⁽¹⁾	Ekip COM STA TCP	
RHD								✓		✓	✓	✓	✓	✓	✓	✓	✓	✓	✓	✓	✓	✓	✓	✓	✓	
RHE								✓		✓	✓	✓	✓	✓	✓	✓	✓	✓	✓	✓	✓	✓	✓	✓	✓	✓
RHS										✓	✓	✓	✓	✓	✓	✓	✓	✓	✓	✓	✓	✓	✓	✓	✓	✓
FLD								✓		✓	✓	✓	✓	✓	✓	✓	✓	✓	✓	✓	✓	✓	✓	✓	✓	✓
MOE/MOE-E									✓	✓	✓	✓	✓	✓	✓	✓	✓	✓	✓	✓	✓	✓	✓	✓	✓	✓
PLL on CB										✓	✓	✓	✓	✓	✓	✓	✓	✓	✓	✓	✓	✓	✓	✓	✓	✓
KLC on CB													✓	✓	✓	✓	✓	✓	✓	✓	✓	✓	✓	✓	✓	✓
RHL	✓	✓		✓						✓	✓	✓	✓	✓	✓	✓	✓	✓	✓	✓	✓	✓	✓	✓	✓	✓
MOL on motor					✓					✓	✓	✓	✓	✓	✓	✓	✓	✓	✓	✓	✓	✓	✓	✓	✓	✓
SOR/UVR 3p	✓	✓	✓	✓	✓	✓		✓	✓				✓	✓	✓	✓	✓	✓	✓	✓	✓	✓	✓	✓	✓	✓
3Q left 3p	✓	✓	✓	✓	✓	✓		✓	✓				✓	✓	✓	✓	✓	✓	✓	✓	✓	✓	✓	✓	✓	✓
RC Coil 3p	✓	✓	✓	✓	✓	✓		✓	✓				✓	✓	✓	✓	✓	✓	✓	✓	✓	✓	✓	✓	✓	✓
SOR/UVR 4p	✓	✓	✓	✓	✓	✓	✓	✓	✓	✓	✓	✓			✓	✓	✓	✓	✓	✓	✓	✓	✓	✓	✓	✓
3Q left 4p	✓	✓	✓	✓	✓	✓	✓	✓	✓	✓	✓	✓			✓	✓	✓	✓	✓	✓	✓	✓	✓	✓	✓	✓
1Q+1SY	✓	✓	✓	✓	✓	✓	✓	✓	✓	✓	✓	✓	✓	✓						✓		✓	✓		✓	✓
2Q+1SY	✓	✓	✓	✓	✓	✓	✓	✓	✓	✓	✓	✓	✓	✓						✓		✓	✓		✓	✓
3Q+1SY	✓	✓	✓	✓	✓	✓	✓	✓	✓	✓	✓	✓	✓	✓						✓		✓	✓		✓	✓
3Q+2SY	✓	✓	✓	✓	✓	✓	✓	✓	✓	✓	✓	✓	✓	✓								✓	✓		✓	✓
2Q+2SY+1S51	✓	✓	✓	✓	✓	✓	✓	✓	✓	✓	✓	✓	✓	✓								✓	✓		✓	✓
1S51	✓	✓	✓	✓	✓	✓	✓	✓	✓	✓	✓	✓	✓	✓	✓	✓	✓					✓	✓	✓	✓	✓
400V 2Q	✓	✓	✓	✓	✓	✓	✓	✓	✓	✓	✓	✓	✓	✓								✓	✓		✓	✓
400V 1Q+1SY	✓	✓	✓	✓	✓	✓	✓	✓	✓	✓	✓	✓	✓	✓								✓	✓		✓	✓
AUE	✓	✓						✓		✓	✓	✓	✓	✓	✓	✓	✓	✓	✓	✓	✓	✓	✓	✓	✓	✓
Ekip COM STA RTU / Ekip COM LSI-LSIG ⁽¹⁾	✓	✓	✓	✓	✓	✓	✓	✓	✓	✓	✓	✓	✓	✓							✓	✓		✓	✓	✓
Ekip COM STA TCP	✓	✓	✓	✓	✓	✓	✓	✓	✓	✓	✓	✓	✓	✓								✓	✓		✓	✓

✓ Compatible

(1) Ekip COM LSI-LSIG is only available with Ekip LSI and LSIG trip units

Circuit-breakers with electronic Ekip Touch and Ekip Hi-Touch trip units

	RHD	RHE	RHS	FLD	MOE/MOE-E	PLL ON CB	KLC ON CB	RHL	MOL ON MOTOR	SOR/UVR 3P	3Q LEFT 3P	RC COIL 3P	SOR/UVR 4P	3Q LEFT 4P	AUE	EKIP COM
RHD								✓		✓	✓	✓	✓	✓	✓	✓
RHE								✓		✓	✓	✓	✓	✓	✓	✓
RHS										✓	✓	✓	✓	✓	✓	✓
FLD								✓		✓	✓	✓	✓	✓	✓	✓
MOE/MOE-E									✓	✓	✓	✓	✓	✓	✓	✓
PLL on CB										✓	✓	✓	✓	✓	✓	✓
KLC on CB													✓	✓	✓	✓
RHL	✓	✓		✓						✓	✓	✓	✓	✓	✓	✓
MOL on motor					✓					✓	✓	✓	✓	✓	✓	✓
SOR/UVR 3p	✓	✓	✓	✓	✓	✓		✓	✓				✓	✓	✓	✓
3Q left 3p	✓	✓	✓	✓	✓	✓		✓	✓				✓	✓	✓	✓
RC Coil 3p	✓	✓	✓	✓	✓	✓		✓	✓				✓	✓	✓	✓
SOR/UVR 4p	✓	✓	✓	✓	✓	✓	✓	✓	✓	✓	✓	✓			✓	✓
3Q left 4p	✓	✓	✓	✓	✓	✓	✓	✓	✓	✓	✓	✓			✓	✓
AUE	✓	✓						✓		✓	✓	✓	✓	✓	✓	✓
Ekip COM	✓	✓	✓	✓	✓	✓	✓	✓	✓	✓	✓	✓	✓	✓	✓	✓

✓ Compatible

Compatibility of accessories

Tmax XT5

Circuit-breakers with thermal-magnetic or electronic Ekip Dip trip units

	RHD	RHE	CK RHE->RHS	FLD	MOE/MOE-E	PLL on CB	KLC on CB	RHL	MOL on motor	YO/YU 3p	YO/YU 1p	1Q+1SY	1Q+1SY left	2Q+1SY	3Q+1SY	1S51	1S52	400V 2Q	400V 1Q+1SY	AUE	Ekip COM STA RTU/TCP	
RHD	✓							✓		✓	✓	✓	✓	✓	✓	✓	✓	✓	✓	✓	✓	✓
RHE		✓						✓		✓	✓	✓	✓	✓	✓	✓	✓	✓	✓	✓	✓	✓
CK RHE->RHS		✓						✓		✓	✓	✓	✓	✓	✓	✓	✓	✓	✓	✓	✓	✓
FLD				✓				✓		✓	✓	✓	✓	✓	✓	✓	✓	✓	✓	✓	✓	✓
MOE/MOE-E					✓				✓	✓	✓	✓	✓	✓	✓	✓	✓	✓	✓	✓	✓	✓
PLL on CB						✓				✓	✓	✓	✓	✓	✓	✓	✓	✓	✓	✓	✓	✓
KLC on CB							✓				✓	✓	✓	✓	✓	✓	✓	✓	✓	✓	✓	✓
RHL	✓	✓	✓	✓						✓	✓	✓	✓	✓	✓	✓	✓	✓	✓	✓	✓	✓
MOL on motor					✓				✓	✓	✓	✓	✓	✓	✓	✓	✓	✓	✓	✓	✓	✓
YO/YU 3p	✓	✓	✓	✓	✓	✓		✓	✓		✓	✓	✓	✓	✓	✓	✓	✓	✓	✓	✓	✓
YO/YU 1p	✓	✓	✓	✓	✓	✓	✓	✓	✓			✓	✓	✓	✓	✓	✓	✓	✓	✓	✓	✓
1Q+1SY	✓	✓	✓	✓	✓	✓	✓	✓	✓	✓			✓			✓	✓	✓	✓	✓	✓	✓
1Q+1SY left	✓	✓	✓	✓	✓	✓	✓	✓	✓	✓		✓		✓		✓	✓	✓	✓	✓	✓	✓
2Q+1SY	✓	✓	✓	✓	✓	✓	✓	✓	✓	✓			✓			✓	✓	✓	✓	✓	✓	✓
3Q+1SY	✓	✓	✓	✓	✓	✓	✓	✓	✓	✓			✓			✓	✓	✓	✓	✓	✓	✓
1S51	✓	✓	✓	✓	✓	✓	✓	✓	✓	✓	✓	✓	✓	✓	✓	✓	✓	✓	✓	✓	✓	✓
1S52	✓	✓	✓	✓	✓	✓		✓	✓	✓	✓	✓	✓	✓	✓	✓	✓	✓	✓	✓	✓	✓
400V 2Q	✓	✓	✓	✓	✓	✓	✓	✓	✓	✓		✓	✓	✓	✓	✓	✓	✓	✓	✓	✓	✓
400V 1Q+1SY	✓	✓	✓	✓	✓	✓		✓	✓		✓	✓	✓	✓	✓	✓	✓	✓	✓	✓	✓	✓
AUE	✓	✓						✓		✓	✓	✓	✓	✓	✓	✓	✓	✓	✓	✓	✓	✓
Ekip COM STA RTU/TCP	✓	✓	✓	✓	✓	✓	✓	✓	✓	✓	✓	✓	✓	✓	✓	✓	✓	✓	✓	✓	✓	✓

✓ Compatible

Circuit-breakers with electronic Ekip Touch and Ekip Hi-Touch trip units

	RHD	RHE	CK RHE->RHS	FLD	MOE/MOE-E	PLL on CB	KLC on CB	RHL	MOL on motor	YO/YU 3p	YO/YU 1p	1Q+1SY	2Q+1SY	3Q+1SY	1S51	1S52	400V 2Q	AUE	Ekip COM	Ekip 1K
RHD								✓		✓	✓	✓	✓	✓	✓	✓	✓	✓	✓	✓
RHE			✓					✓		✓	✓	✓	✓	✓	✓	✓	✓	✓	✓	✓
CK RHE->RHS		✓						✓		✓	✓	✓	✓	✓	✓	✓	✓	✓	✓	✓
FLD								✓		✓	✓	✓	✓	✓	✓	✓	✓	✓	✓	✓
MOE/MOE-E									✓	✓	✓	✓	✓	✓	✓	✓	✓	✓	✓	✓
PLL on CB										✓	✓	✓	✓	✓	✓	✓	✓	✓	✓	✓
KLC on CB											✓	✓	✓	✓	✓	✓	✓	✓	✓	✓
RHL	✓	✓	✓	✓						✓	✓	✓	✓	✓	✓	✓	✓	✓	✓	✓
MOL on motor					✓					✓	✓	✓	✓	✓	✓	✓	✓	✓	✓	✓
YO/YU 3p	✓	✓	✓	✓	✓	✓	✓	✓	✓		✓	✓	✓	✓	✓	✓	✓	✓	✓	✓
YO/YU 1p	✓	✓	✓	✓	✓	✓	✓	✓	✓			✓	✓	✓	✓	✓	✓	✓	✓	✓
1Q+1SY	✓	✓	✓	✓	✓	✓	✓	✓	✓	✓					✓	✓	✓	✓	✓	✓
2Q+1SY	✓	✓	✓	✓	✓	✓	✓	✓	✓	✓					✓	✓	✓	✓	✓	✓
3Q+1SY	✓	✓	✓	✓	✓	✓	✓	✓	✓	✓					✓	✓	✓	✓	✓	✓
1S51	✓	✓	✓	✓	✓	✓	✓	✓	✓	✓	✓	✓	✓	✓		✓	✓	✓	✓	✓
1S52	✓	✓	✓	✓	✓	✓	✓	✓	✓	✓	✓	✓	✓	✓	✓		✓	✓	✓	✓
400V 2Q	✓	✓	✓	✓	✓	✓	✓	✓	✓	✓		✓	✓	✓	✓	✓	✓	✓	✓	✓
AUE	✓	✓						✓		✓	✓	✓	✓	✓	✓	✓	✓	✓	✓	✓
Ekip COM	✓	✓	✓	✓	✓	✓	✓	✓	✓	✓	✓	✓	✓	✓	✓	✓	✓	✓	✓	✓
Ekip 1K	✓	✓	✓	✓	✓	✓	✓	✓	✓		✓	✓	✓	✓	✓	✓	✓	✓	✓	✓

✓ Compatible

Compatibility of accessories

Tmax XT6

	RHD	RHE	FLD	MOE/MOE-E	PLL on CB	KLC on CB	RHL	MOL on motor	YU 3p	YO 1p	1Q+1SY	2Q+1SY	3Q+1SY	1S51	1S52
RHD							✓		✓	✓	✓	✓	✓	✓	✓
RHE							✓		✓	✓	✓	✓	✓	✓	✓
FLD							✓		✓	✓	✓	✓	✓	✓	✓
MOE/MOE-E								✓	✓	✓	✓	✓	✓	✓	✓
PLL on CB									✓	✓	✓	✓	✓	✓	✓
KLC on CB										✓	✓	✓	✓	✓	✓
RHL	✓	✓	✓						✓	✓	✓	✓	✓	✓	✓
MOL on motor				✓					✓	✓	✓	✓	✓	✓	✓
YU 3p	✓	✓	✓	✓	✓		✓	✓		✓	✓	✓	✓	✓	✓
YO 1p	✓	✓	✓	✓	✓	✓	✓	✓	✓		✓	✓	✓	✓	✓
1Q+1SY	✓	✓	✓	✓	✓	✓	✓	✓	✓	✓				✓	✓
2Q+1SY	✓	✓	✓	✓	✓	✓	✓	✓	✓	✓				✓	✓
3Q+1SY	✓	✓	✓	✓	✓	✓	✓	✓	✓	✓				✓	✓
1S51	✓	✓	✓	✓	✓	✓	✓	✓	✓	✓	✓	✓	✓		✓
1S52	✓	✓	✓	✓	✓		✓	✓	✓	✓	✓	✓	✓	✓	✓

✓ Compatible

Tmax XT7

In addition to the accessories listed in the table below, it is always possible to complement the XT7 circuit-breakers with the Ekip Supply module and up to other two modules. Alternatives to the Ekip supply, 24V and CAN modules can be directly connected by using appropriate terminal blocks.

	RHD	RHE	PLC on CB	KLC on CB	RHL	YO	YU / YO2	4Q	1SY	1S51	1S52	AUE
RHD					✓	✓	✓	✓	✓	✓	✓	✓
RHE					✓	✓	✓	✓	✓	✓	✓	✓
PLC on CB				✓		✓	✓	✓	✓	✓	✓	
KLC on CB			✓			✓	✓	✓	✓	✓	✓	
RHL	✓	✓				✓	✓	✓	✓	✓	✓	✓
YO	✓	✓	✓	✓	✓		✓	✓	✓	✓	✓	✓
YU / YO2	✓	✓	✓	✓	✓	✓		✓	✓	✓	✓	✓
4Q	✓	✓	✓	✓	✓	✓	✓		✓	✓	✓	✓
1SY	✓	✓	✓	✓	✓	✓	✓	✓		✓	✓	✓
1S51	✓	✓	✓	✓	✓	✓	✓	✓	✓		✓	✓
1S52	✓	✓	✓	✓	✓	✓	✓	✓	✓	✓		✓
AUE	✓	✓			✓	✓	✓	✓	✓	✓	✓	

✓ Compatible

Tmax XT7 M

In addition to the accessories listed in the table below, it is always possible to complement the XT7 M circuit-breakers with the Ekip Supply module and up to other two modules. Alternatives to the Ekip supply, 24V and CAN modules can be directly connected by using appropriate terminal blocks.

	PLC on CB	KLC on CB	PBC	MOC	YO	YU / YO2	YC	YR	RTC	4Q	1S51	S33M/2	M	Ekip COM act.	RTC Ekip
PLC on CB		✓		✓	✓	✓	✓	✓	✓	✓	✓	✓	✓	✓	✓
KLC on CB	✓		✓	✓	✓	✓	✓	✓	✓	✓	✓	✓	✓	✓	✓
PBC		✓		✓	✓	✓	✓	✓	✓	✓	✓	✓	✓	✓	✓
MOC	✓	✓	✓		✓	✓	✓	✓	✓	✓	✓	✓	✓	✓	✓
YO	✓	✓	✓	✓		✓	✓	✓	✓	✓	✓	✓	✓	✓	✓
YU / YO2	✓	✓	✓	✓	✓		✓	✓	✓	✓	✓	✓	✓	✓	✓
YC	✓	✓	✓	✓	✓	✓		✓	✓	✓	✓	✓	✓	✓	✓
YR	✓	✓	✓	✓	✓	✓	✓		✓	✓	✓	✓	✓	✓	✓
RTC	✓	✓	✓	✓	✓	✓	✓	✓		✓	✓	✓	✓	✓	✓
4Q	✓	✓	✓	✓	✓	✓	✓	✓	✓		✓	✓	✓	✓	✓
1S51	✓	✓	✓	✓	✓	✓	✓	✓	✓	✓		✓	✓	✓	✓
S33M/2	✓	✓	✓	✓	✓	✓	✓	✓	✓	✓	✓		✓	✓	✓
M	✓	✓	✓	✓	✓	✓	✓	✓	✓	✓	✓	✓		✓	✓
Ekip COM act.	✓	✓	✓	✓	✓	✓	✓	✓	✓	✓	✓	✓	✓		✓
RTC Ekip	✓	✓	✓	✓	✓	✓	✓	✓	✓	✓	✓	✓	✓	✓	

✓ Compatible

Compatibility of accessories

Withdrawable versions

Tmax XT2-XT4

	1S51	1Q+1SY	3Q+1SY	3Q+2SY	2Q+2SY+1S51	2Q 400V	1Q+1SY 400V	Ekip COM / Ekip COM STA TCP	Ekip COM STA RTU / Ekip COM LSI-LSIG ⁽¹⁾	NE	MOE	MOE-E	AUX-MO	AUE	SOR/UVR 3p	RC Coil 3p	SOR/UVR 4p
1S51		✓								✓	✓	✓	✓	✓	✓	✓	✓
1Q+1SY	✓									✓	✓	✓	✓	✓	✓	✓	✓
3Q+1SY										✓	✓	✓	✓	✓	✓	✓	✓
3Q+2SY											✓	✓	✓	✓	✓	✓	✓
2Q+2SY+1S51											✓	✓	✓	✓	✓	✓	✓
2Q 400V										✓	✓	✓	✓	✓	✓	✓	✓
1Q+1SY 400V										✓	✓	✓	✓	✓	✓	✓	✓
Ekip COM / Ekip COM STA TCP										✓	✓	✓	✓	✓	✓	✓	✓
Ekip COM STA RTU / Ekip COM LSI-LSIG ⁽¹⁾	✓									✓	✓	✓	✓	✓	✓	✓	✓
NE	✓	✓	✓			✓	✓	✓	✓		✓	✓	✓	✓	✓	✓	✓
MOE	✓	✓	✓	✓	✓	✓	✓	✓	✓	✓			✓		✓	✓	✓
MOE-E	✓	✓	✓	✓	✓	✓	✓	✓	✓	✓			✓		✓	✓	✓
AUX-MO	✓	✓	✓	✓	✓	✓	✓	✓	✓	✓	✓	✓			✓	✓	✓
AUE	✓	✓	✓	✓	✓	✓	✓	✓	✓	✓					✓	✓	✓
SOR/UVR 3p	✓	✓	✓	✓	✓	✓	✓	✓	✓	✓	✓	✓	✓	✓			✓
RC Coil 3p	✓	✓	✓	✓	✓	✓	✓	✓	✓	✓	✓	✓	✓	✓			✓
SOR/UVR 4p	✓	✓	✓	✓	✓	✓	✓	✓	✓	✓	✓	✓		✓	✓	✓	✓

✓ Compatible

(1) Ekip COM LSI-LSIG is only available with Ekip LSI and LSI-G trip units

With the Ekip Touch and Hi-Touch trip units there is always an additional connector for 24V and CAN modules to be mounted on the left side of the moving part.

Tmax XT5

	1S52	1S51	1Q+1SY	2Q+1SY	3Q+1SY	2Q 400V	1Q+1SY 400V	Ekip COM	Ekip COM STARTU	Ekip COM STATCP	MOE	MOE-E	AUE	YO/YU 3p	YO/YU 1p	Ekip 1K
1S52		✓	✓	✓	✓	✓					✓	✓	✓	✓	✓	✓
1S51	✓		✓	✓	✓	✓	✓	✓	✓	✓	✓	✓	✓	✓	✓	✓
1Q+1SY	✓	✓				✓	✓	✓ ⁽¹⁾		✓	✓	✓	✓	✓	✓	✓
2Q+1SY	✓	✓					✓	✓ ⁽¹⁾		✓	✓	✓	✓	✓	✓	✓
3Q+1SY	✓	✓					✓	✓ ⁽¹⁾		✓	✓	✓	✓	✓	✓	✓
2Q 400V	✓	✓	✓				✓	✓	✓	✓	✓	✓	✓	✓		
1Q+1SY 400V		✓	✓	✓	✓	✓					✓	✓	✓		✓	
Ekip COM		✓	✓ ⁽¹⁾	✓ ⁽¹⁾	✓ ⁽¹⁾	✓					✓	✓	✓		✓	✓
Ekip COM STA RTU		✓				✓					✓	✓	✓		✓	✓
Ekip COM STA TCP		✓	✓	✓	✓	✓					✓	✓	✓	✓	✓	✓
MOE	✓	✓	✓	✓	✓	✓	✓	✓	✓	✓				✓	✓	✓
MOE-E	✓	✓	✓	✓	✓	✓	✓	✓	✓	✓				✓	✓	✓
AUE	✓	✓	✓	✓	✓	✓	✓	✓	✓	✓				✓	✓	✓
YO/YU 3p	✓	✓	✓	✓	✓	✓				✓	✓	✓	✓		✓	✓
YO/YU 1p	✓	✓	✓	✓	✓		✓	✓	✓	✓	✓	✓	✓	✓		✓
Ekip 1K		✓	✓					✓	✓	✓	✓	✓	✓		✓	✓

✓ Compatible

(1) In case of the Ekip COM Modbus, RTU, the tick must be disregarded.

Tmax XT6

	1S52	1S51	1Q+1SY	2Q+1SY	3Q+1SY	MOE	MOE-E	YU 3p	YO 1p
1S52		✓	✓	✓	✓	✓	✓		✓
1S51	✓		✓	✓	✓	✓	✓	✓	✓
1Q+1SY	✓	✓				✓	✓	✓	✓
2Q+1SY	✓	✓				✓	✓	✓	✓
3Q+1SY	✓	✓				✓	✓	✓	✓
MOE	✓	✓	✓	✓	✓			✓	✓
MOE-E	✓	✓	✓	✓	✓			✓	✓
YU 3p		✓	✓	✓	✓	✓	✓		✓
YO 1p	✓	✓	✓	✓	✓	✓	✓	✓	✓

✓ Compatible

Compatibility of accessories

Position of the internal accessories for the Tmax XT1

Tmax XT1

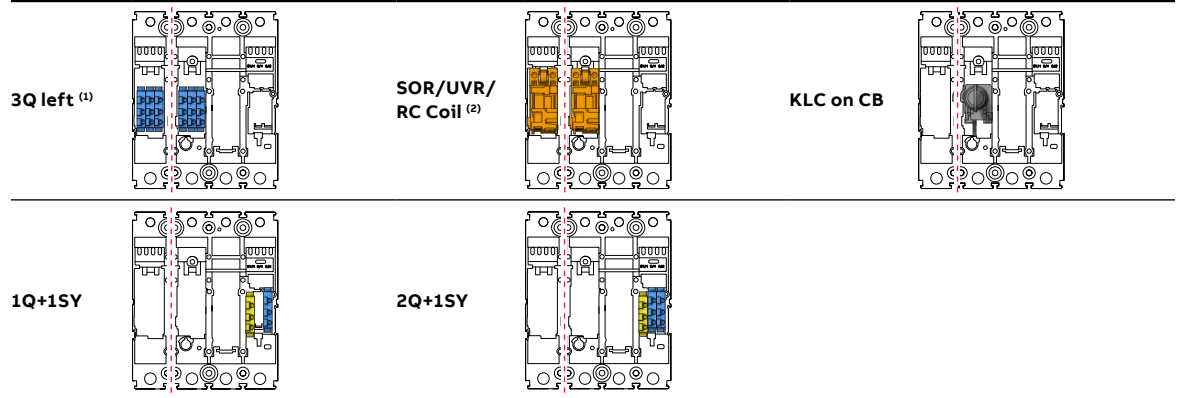

(1) For 4-pole version, 3Q left on the fourth pole only.

(2) RC Coil on the third pole only.

Position of the internal accessories for the Tmax XT3

Tmax XT3

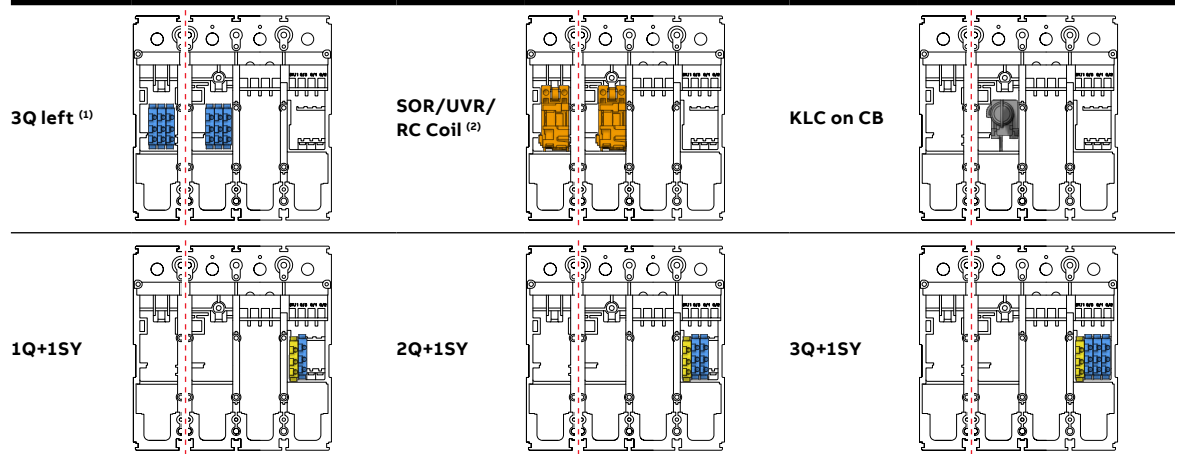

(1) For 4-pole version, 3Q left on the fourth pole only.

(2) RC Coil on the third pole only.

Position of the internal accessories for the Tmax XT2-XT4

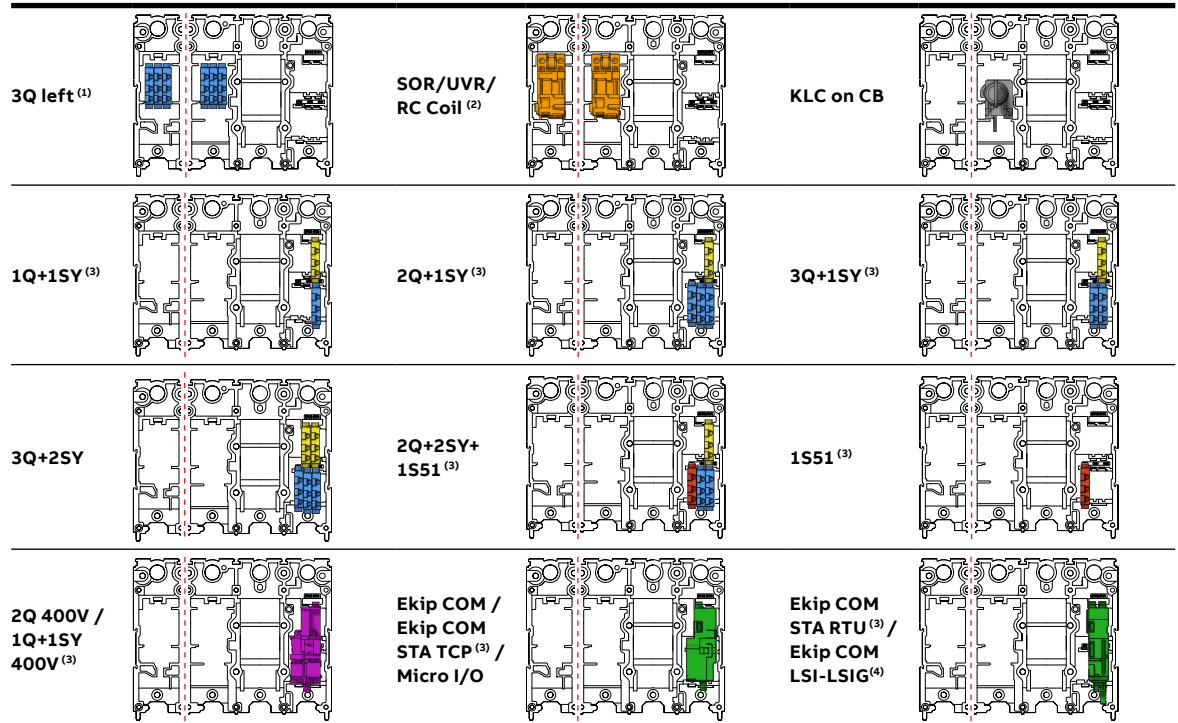
Tmax XT2-XT4

(1) For 4-pole version, 3Q left on the fourth pole only.

(2) RC Coil on the third pole only.

(3) Not available for the Ekip Touch and Hi-Touch trip units.

(4) Available only on Ekip LSI and Ekip LSIG.

Compatibility of accessories

Position of the internal accessories for the Tmax XT5

Tmax XT5

With 4-pole circuit-breakers, it is not possible to add accessories to the fourth pole.

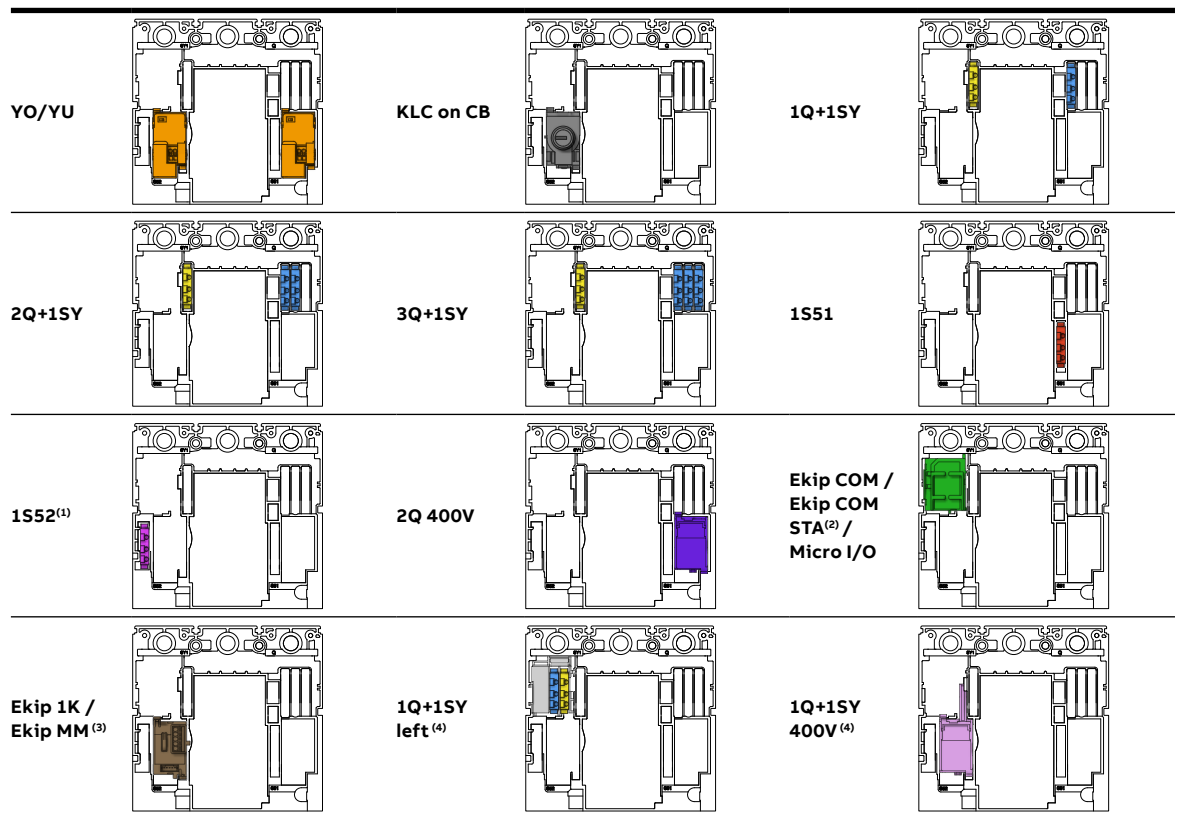

(1) YO or YU must be mounted on the third pole to make S52 signaling available.

(2) Ekip COM or stand-alone module, depending on the trip unit.

(3) Available for the Ekip Touch and Ekip Hi-Touch only.

(4) Available for the TM trip unit, Ekip Dip trip unit and molded case switches only.

Position of the internal accessories for the Tmax XT6

Tmax XT6

With 4-pole circuit-breakers, it is not possible to add accessories to the fourth pole.

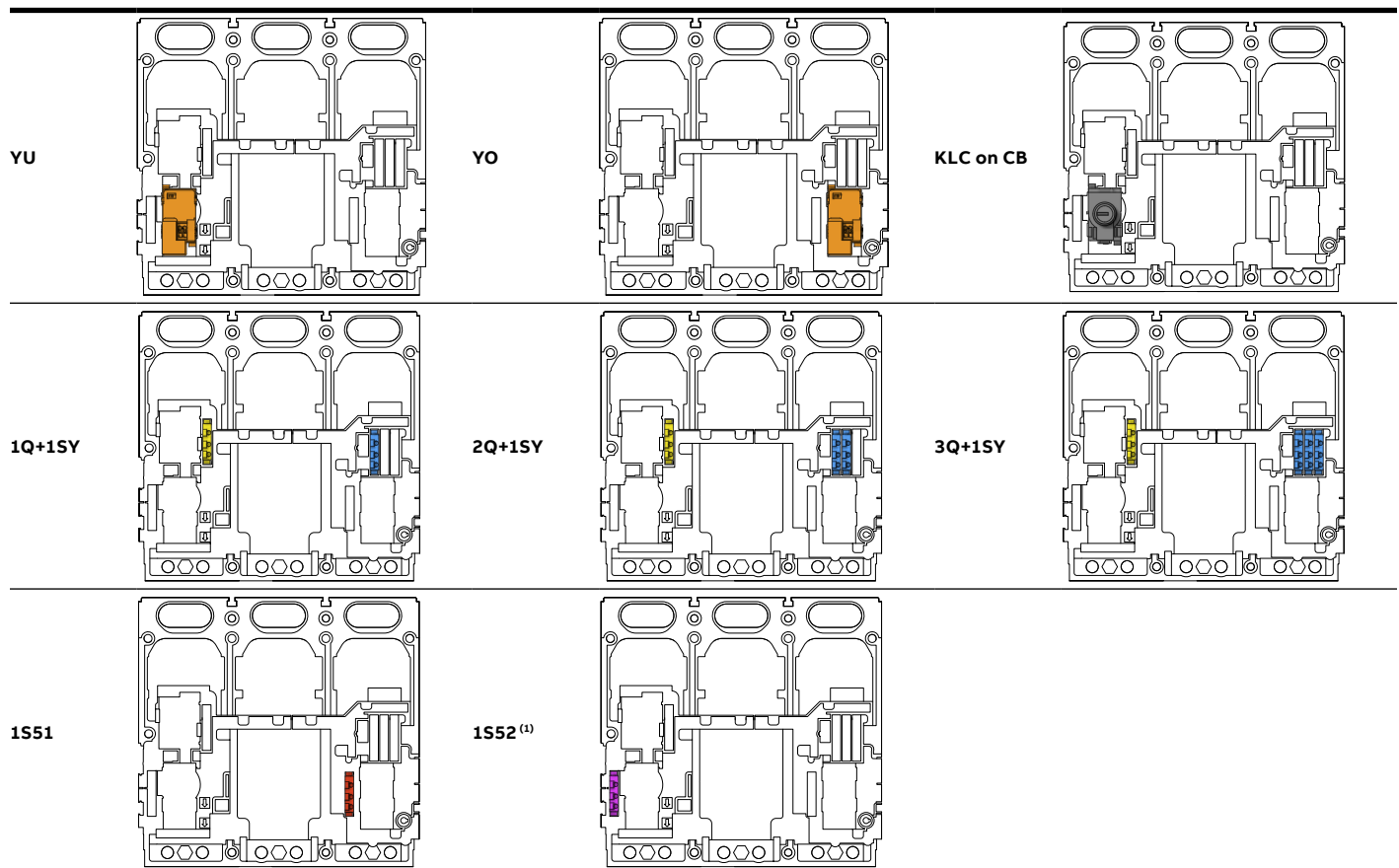

(1) The YU must be mounted on the third pole to make S52 signaling available.

Compatibility of accessories

Position of the internal accessories for the Tmax XT7

Tmax XT7

All internal accessories for the XT7 can be mounted at the same time without any restriction concerning their compatibility. To guarantee proper operation of all accessories, please refer to the relevant tables (see previous pages).

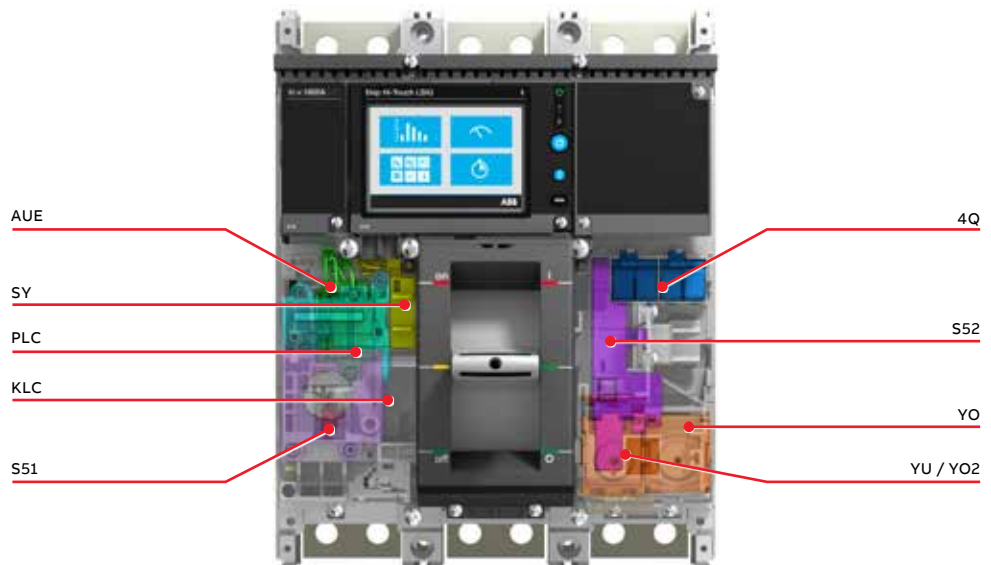

Position of the internal accessories for the Tmax XT7 M

Tmax XT7 M

All internal accessories for the XT7 M can be mounted at the same time without any restriction concerning their compatibility. To guarantee proper operation of all accessories, please refer to the relevant tables (see previous pages).

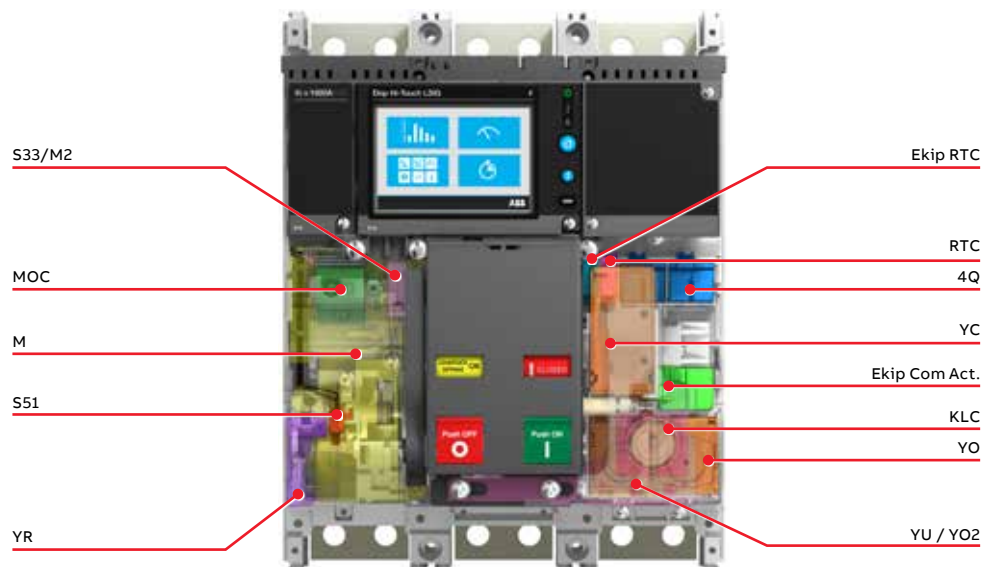

Compatibility of accessories

Reading information

Glossary

RHD	= Direct rotary handle	S51	= Contact signaling tripping due to trip unit
RHE	= Transmitted rotary handle		
RHS	= Lateral transmitted rotary handle	S52	= Contact signaling YO/YU tripping
CK RHE->RHS	= Conversion kit for converting an RHE into an RHS	S33M/2	= Contact signaling loaded springs
FLD	= Front for lever operating mechanism	AUE	= Early auxiliary contacts
MOD	= Direct action motor operator	RTC	= Ready to close signaling contact
MOE/MOE-E	= Stored energy motor operator	PBC	= Protection device for opening and closing pushbuttons
M	= Motor operator	MOC	= Mechanical operation counter
PLL on CB	= Padlock device on circuit-breaker	NE	= Neutral external
KLC on CB	= Keylock device on circuit-breaker	AUX-MO	= Auxiliary contacts for stored energy motor operator
RHL	= Keylock for rotary handle and front for lever operating mechanism	Micro I/O	= Module for Touch and Hi-Touch trip unit
MOL on motor	= Keylock for motor operator	Ekip COM STA	= Communication module stand-alone
SOR	= Shunt opening release	Ekip COM STA RTU	= Communication module stand-alone Modbus RTU
UVR	= Undervoltage release	Ekip COM STA TCP	= Communication module stand-alone Modbus TCP
YO	= Shunt opening release	Ekip COM	= Communication module
YU	= Undervoltage release	Ekip COM act.	= Ekip COM actuator
YC	= Closing release	Ekip 1K	= Ekip 1K signaling
YR	= Remote resetting	Ekip MM	= Ekip Maintenance Module
RC Coil	= Coil for residual current device	Ekip COM LSI-LSIG	= Communication module for Ekip LSI and LSIG XT2-XT4
Q	= Contact signaling open/closed		
SY	= Contact signaling tripping		

Ordering codes

	Ordering codes for XT1
8/3	Automatic circuit-breakers
	Ordering codes for XT2
8/7	Automatic circuit-breakers
8/20	Breaking part
8/21	Trip units
8/22	Breaking part + trip unit solution
	Ordering codes for XT3
8/23	Automatic circuit-breakers
	Ordering codes for XT4
8/24	Automatic circuit-breakers
8/41	Breaking part
8/42	Trip units
8/44	Breaking part + trip unit solution
	Ordering codes for XT5
8/46	Automatic circuit-breakers
8/59	Breaking part
8/60	Trip units
8/62	Breaking part + trip unit solution
	Ordering codes for XT6
8/63	Automatic circuit-breakers
8/67	Breaking part
8/68	Trip units
8/69	Breaking part + trip unit solution
	Ordering codes for XT7/XT7 M
8/70	Automatic circuit-breakers – XT7
8/82	Automatic circuit-breakers – XT7 M
8/95	Trip units – XT7/XT7 M

Ordering codes

Ordering codes for accessories

8/96	Execution and installation
8/96	Fixed parts
8/97	Conversion kits
8/98	Plug and socket adapters
8/98	Bracket for fixing on DIN-rail
8/98	Floor fixing plate
8/98	Cable rack
8/99	Power connection
8/99	Terminals for circuit-breaker
8/102	Terminals for fixed parts
8/103	Fixed part adapters
8/104	Signaling
8/104	Auxiliary contacts - AUX
8/107	Auxiliary position contacts – AUP
8/107	Early auxiliary contacts – AUE
8/108	Operating mechanism
8/108	Rotary and flange handle operating mechanism
8/111	Front for operating lever mechanism - FLD
8/112	Remote control
8/112	Shunt opening release
8/113	Undervoltage release
8/115	Delay device for undervoltage release - UVD
8/116	Connectors for shunt opening and undervoltage release for withdrawable version
8/116	Resetting remotely - YR
8/116	Motor operator

8/119	Safety and protection
8/119	Terminals covers and phase separators
8/121	IP Protections
8/121	MOC
8/122	Keylocks and padlocks
8/127	Flanges
8/128	Interlocks and switching devices
8/128	Automatic transfer devices
8/130	Residual current devices
8/131	Accessories for electronic Ekip LSI, Ekip LSIG and Ekip M-LRIU trip units
8/132	Accessories for electronic Ekip Touch trip units
8/132	Ekip cartridge
8/132	Power supply modules
8/132	Connectivity modules
8/134	Signaling modules
8/134	Other modules
8/136	Advanced functionality
8/137	Display and supervision systems
8/138	Other accessories for trip units
8/138	Test and configuration
8/138	Current sensors
8/139	Rating plug for Ekip trip units

Ordering codes for XT1

Automatic circuit-breakers

Distribution circuit-breakers

SACE XT1N (25kA) TMF Front terminals (F)



XT1 - circuit-breaker

Size	lu	Trip units	In	Type	3 poles	4 poles
					Code	Code
XT1	125	TMF	15	XT1N 125 TMF 15-500	1SDA074634R1	1SDA074649R1
			20	XT1N 125 TMF 20-500	1SDA074635R1	1SDA074650R1
			25	XT1N 125 TMF 25-500	1SDA074636R1	1SDA074651R1
			30	XT1N 125 TMF 30-500	1SDA074637R1	1SDA074652R1
			35	XT1N 125 TMF 35-500	1SDA074638R1	1SDA074653R1
			40	XT1N 125 TMF 40-500	1SDA074639R1	1SDA074654R1
			45	XT1N 125 TMF 45-500	1SDA074640R1	1SDA074655R1
			50	XT1N 125 TMF 50-500	1SDA074641R1	1SDA074656R1
			60	XT1N 125 TMF 60-600	1SDA074642R1	1SDA074657R1
			70	XT1N 125 TMF 70-700	1SDA074643R1	1SDA074658R1
			80	XT1N 125 TMF 80-800	1SDA074644R1	1SDA074659R1
			90	XT1N 125 TMF 90-900	1SDA074645R1	1SDA074660R1
			100	XT1N 125 TMF 100-1000	1SDA074646R1	1SDA074661R1
110	XT1N 125 TMF 110-1100	1SDA074647R1	1SDA074662R1			
125	XT1N 125 TMF 125-1250	1SDA074648R1	1SDA074663R1			

SACE XT1S (35kA) TMF Front terminals (F)

Size	lu	Trip units	In	Type	3 poles	4 poles
					Code	Code
XT1	125	TMF	15	XT1S 125 TMF 15-500	1SDA074664R1	1SDA074679R1
			20	XT1S 125 TMF 20-500	1SDA074665R1	1SDA074680R1
			25	XT1S 125 TMF 25-500	1SDA074666R1	1SDA074681R1
			30	XT1S 125 TMF 30-500	1SDA074667R1	1SDA074682R1
			35	XT1S 125 TMF 35-500	1SDA074668R1	1SDA074683R1
			40	XT1S 125 TMF 40-500	1SDA074669R1	1SDA074684R1
			45	XT1S 125 TMF 45-500	1SDA074670R1	1SDA074685R1
			50	XT1S 125 TMF 50-500	1SDA074671R1	1SDA074686R1
			60	XT1S 125 TMF 60-600	1SDA074672R1	1SDA074687R1
			70	XT1S 125 TMF 70-700	1SDA074673R1	1SDA074688R1
			80	XT1S 125 TMF 80-800	1SDA074674R1	1SDA074689R1
			90	XT1S 125 TMF 90-900	1SDA074675R1	1SDA074690R1
			100	XT1S 125 TMF 100-1000	1SDA074676R1	1SDA074691R1
110	XT1S 125 TMF 110-1100	1SDA074677R1	1SDA074692R1			
125	XT1S 125 TMF 125-1250	1SDA074678R1	1SDA074693R1			



—
XT1 - circuit-breaker

SACE XT1H (65kA) TMF Front terminals (F)

Size	Iu	Trip units	In	Type	3 poles	4 poles
					Code	Code
XT1	125	TMF	15	XT1H 125 TMF 15-500	1SDA074694R1	1SDA074709R1
			20	XT1H 125 TMF 20-500	1SDA074695R1	1SDA074710R1
			25	XT1H 125 TMF 25-500	1SDA074696R1	1SDA074711R1
			30	XT1H 125 TMF 30-500	1SDA074697R1	1SDA074712R1
			35	XT1H 125 TMF 35-500	1SDA074698R1	1SDA074713R1
			40	XT1H 125 TMF 40-500	1SDA074699R1	1SDA074714R1
			45	XT1H 125 TMF 45-500	1SDA074700R1	1SDA074715R1
			50	XT1H 125 TMF 50-500	1SDA074701R1	1SDA074716R1
			60	XT1H 125 TMF 60-600	1SDA074702R1	1SDA074717R1
			70	XT1H 125 TMF 70-700	1SDA074703R1	1SDA074718R1
			80	XT1H 125 TMF 80-800	1SDA074704R1	1SDA074719R1
			90	XT1H 125 TMF 90-900	1SDA074705R1	1SDA074720R1
			100	XT1H 125 TMF 100-1000	1SDA074706R1	1SDA074721R1
			110	XT1H 125 TMF 110-1100	1SDA074707R1	1SDA074722R1
125	XT1H 125 TMF 125-1250	1SDA074708R1	1SDA074723R1			

Ordering codes for XT1

Automatic circuit-breakers

Motor protection circuit-breaker (MCP)

SACE XT1H (65kA) MA Front terminals (F)



XT1 - circuit-breaker

Size	Iu	Trip units	In	Type	3 poles	4 poles
					Code	Code
XT1	125	MA	3	XT1H 125 MA 3	1SDA074724R1	
			7	XT1H 125 MA 7	1SDA074725R1	
			15	XT1H 125 MA 15	1SDA074726R1	
			30	XT1H 125 MA 30	1SDA074727R1	
			50	XT1H 125 MA 50	1SDA074728R1	
			70	XT1H 125 MA 70	1SDA074729R1	
			80	XT1H 125 MA 80	1SDA074730R1	
			100	XT1H 125 MA 100	1SDA074731R1	
		125	XT1H 125 MA 125	1SDA074732R1		

Molded case switches

SACE XT1D - MCS



XT1 - circuit-breaker

Size	Iu	Type	3 poles	4 poles
			Code	Code
XT1	125	XT1N-D 125	1SDA075610R1	1SDA075611R1
		XT1S-D 125	1SDA075612R1	1SDA075613R1
		XT1H-D 125	1SDA075614R1	1SDA075615R1

100% rated distribution circuit-breakers

100% rated version extra code

Size	3 poles	4 poles
	Code	Code
XT1	1SDA076603R1	1SDA080698R1

Note: to be specified only in addition to the code of the automatic circuit-breaker

Ordering codes for XT2

Automatic circuit-breakers

Distribution circuit-breakers



XT2 - circuit-breaker

SACE XT2N (25kA) TMF/TMA Front terminals (F)

Size	lu	Trip units	In	Type	3 poles	4 poles
					Code	Code
XT2	125	TMF	15	XT2N 125 TMF 15-400	1SDA074733R1	1SDA074747R1
			20	XT2N 125 TMF 20-400	1SDA074734R1	1SDA074748R1
			25	XT2N 125 TMF 25-400	1SDA074735R1	1SDA074749R1
			30	XT2N 125 TMF 30-400	1SDA074736R1	1SDA074750R1
			35	XT2N 125 TMF 35-400	1SDA074737R1	1SDA074751R1
			40	XT2N 125 TMF 40-400	1SDA074738R1	1SDA074752R1
			50	XT2N 125 TMF 50-500	1SDA074739R1	1SDA074753R1
XT2	125	TMA	60	XT2N 125 TMF 60-600	1SDA074740R1	1SDA074754R1
			70	XT2N 125 TMF 70-700	1SDA074741R1	1SDA074755R1
			80	XT2N 125 TMA 80-800	1SDA074742R1	1SDA074756R1
			90	XT2N 125 TMA 90-900	1SDA074743R1	1SDA074757R1
			100	XT2N 125 TMA 100-1000	1SDA074744R1	1SDA074758R1
			110	XT2N 125 TMA 110-1100	1SDA074745R1	1SDA074759R1
			125	XT2N 125 TMA 125-1250	1SDA074746R1	1SDA074760R1

SACE XT2N (25kA) Ekip LS/I Front terminals (F)

Size	lu	Trip units	In	Type	3 poles	4 poles
					Code	Code
XT2	125	Ekip LS/I	10	XT2N 125 Ekip LS/I In=10A	1SDA074900R1	1SDA074905R1
			25	XT2N 125 Ekip LS/I In=25A	1SDA074901R1	1SDA074906R1
			60	XT2N 125 Ekip LS/I In=60A	1SDA074902R1	1SDA074907R1
			100	XT2N 125 Ekip LS/I In=100A	1SDA074903R1	1SDA074908R1
			125	XT2N 125 Ekip LS/I In=125A	1SDA074904R1	1SDA074909R1

SACE XT2N (25kA) Ekip LSI Front terminals (F)

Size	lu	Trip units	In	Type	3 poles	4 poles
					Code	Code
XT2	125	Ekip LSI	10	XT2N 125 Ekip LSI In=10A	1SDA074950R1	1SDA074955R1
			25	XT2N 125 Ekip LSI In=25A	1SDA074951R1	1SDA074956R1
			60	XT2N 125 Ekip LSI In=60A	1SDA074952R1	1SDA074957R1
			100	XT2N 125 Ekip LSI In=100A	1SDA074953R1	1SDA074958R1
			125	XT2N 125 Ekip LSI In=125A	1SDA074954R1	1SDA074959R1

Ordering codes for XT2

Automatic circuit-breakers



—
XT2 - circuit-breaker

SACE XT2N (25kA) Ekip LSIG Front terminals (F)

Size	lu	Trip units	In	Type	3 poles	4 poles
					Code	Code
XT2	125	Ekip LSIG	10	XT2N 125 Ekip LSIG In=10A	1SDA075000R1	1SDA075005R1
			25	XT2N 125 Ekip LSIG In=25A	1SDA075001R1	1SDA075006R1
			60	XT2N 125 Ekip LSIG In=60A	1SDA075002R1	1SDA075007R1
			100	XT2N 125 Ekip LSIG In=100A	1SDA075003R1	1SDA075008R1
			125	XT2N 125 Ekip LSIG In=125A	1SDA075004R1	1SDA075009R1

SACE XT2N (25kA) Ekip Dip LIG Front terminals (F)

Size	lu	Trip units	In	Type	3 poles	4 poles
					Code	Code
XT2	125	Ekip LIG	10	XT2N 125 Ekip Dip LIG In10A	1SDA102047R1	1SDA102112R1
			25	XT2N 125 Ekip Dip LIG In25A	1SDA102048R1	1SDA102113R1
			60	XT2N 125 Ekip Dip LIG In60A	1SDA102049R1	1SDA102114R1
			100	XT2N 125 Ekip Dip LIG In100	1SDA102050R1	1SDA102115R1
			125	XT2N 125 Ekip Dip LIG In125	1SDA102051R1	1SDA102116R1

Distribution circuit-breakers



XT2 - circuit-breaker

SACE XT2S (35kA) TMF/TMA Front terminals (F)

Size	lu	Trip units	In	Type	3 poles	4 poles
					Code	Code
XT2	125	TMF	15	XT2S 125 TMF 15-400	1SDA074761R1	1SDA074775R1
			20	XT2S 125 TMF 20-400	1SDA074762R1	1SDA074776R1
			25	XT2S 125 TMF 25-400	1SDA074763R1	1SDA074777R1
			30	XT2S 125 TMF 30-400	1SDA074764R1	1SDA074778R1
			35	XT2S 125 TMF 35-400	1SDA074765R1	1SDA074779R1
			40	XT2S 125 TMF 40-400	1SDA074766R1	1SDA074780R1
			50	XT2S 125 TMF 50-500	1SDA074767R1	1SDA074781R1
			60	XT2S 125 TMF 60-600	1SDA074768R1	1SDA074782R1
XT2	125	TMA	70	XT2S 125 TMF 70-700	1SDA074769R1	1SDA074783R1
			80	XT2S 125 TMA 80-800	1SDA074770R1	1SDA074784R1
			90	XT2S 125 TMA 90-900	1SDA074771R1	1SDA074785R1
			100	XT2S 125 TMA 100-1000	1SDA074772R1	1SDA074786R1
			110	XT2S 125 TMA 110-1100	1SDA074773R1	1SDA074787R1
			125	XT2S 125 TMA 125-1250	1SDA074774R1	1SDA074788R1

SACE XT2S (35kA) Ekip LS/I Front terminals (F)

Size	lu	Trip units	In	Type	3 poles	4 poles
					Code	Code
XT2	125	Ekip LS/I	10	XT2S 125 Ekip LS/I In=10A	1SDA074910R1	1SDA074915R1
			25	XT2S 125 Ekip LS/I In=25A	1SDA074911R1	1SDA074916R1
			60	XT2S 125 Ekip LS/I In=60A	1SDA074912R1	1SDA074917R1
			100	XT2S 125 Ekip LS/I In=100A	1SDA074913R1	1SDA074918R1
			125	XT2S 125 Ekip LS/I In=125A	1SDA074914R1	1SDA074919R1

SACE XT2S (35kA) Ekip LSI Front terminals (F)

Size	lu	Trip units	In	Type	3 poles	4 poles
					Code	Code
XT2	125	Ekip LSI	10	XT2S 125 Ekip LSI In=10A	1SDA074960R1	1SDA074965R1
			25	XT2S 125 Ekip LSI In=25A	1SDA074961R1	1SDA074966R1
			60	XT2S 125 Ekip LSI In=60A	1SDA074962R1	1SDA074967R1
			100	XT2S 125 Ekip LSI In=100A	1SDA074963R1	1SDA074968R1
			125	XT2S 125 Ekip LSI In=125A	1SDA074964R1	1SDA074969R1

Ordering codes for XT2

Automatic circuit-breakers



—
XT2 - circuit-breaker

SACE XT2S (35kA) Ekip LSIG Front terminals (F)

Size	lu	Trip units	In	Type	3 poles	4 poles
					Code	Code
XT2	125	Ekip LSIG	10	XT2S 125 Ekip LSIG In=10A	1SDA075010R1	1SDA075015R1
			25	XT2S 125 Ekip LSIG In=25A	1SDA075011R1	1SDA075016R1
			60	XT2S 125 Ekip LSIG In=60A	1SDA075012R1	1SDA075017R1
			100	XT2S 125 Ekip LSIG In=100A	1SDA075013R1	1SDA075018R1
			125	XT2S 125 Ekip LSIG In=125A	1SDA075014R1	1SDA075019R1

SACE XT2S (35kA) Ekip Dip LIG Front terminals (F)

Size	lu	Trip units	In	Type	3 poles	4 poles
					Code	Code
XT2	125	Ekip LIG	10	XT2S 125 Ekip Dip LIG In10A	1SDA102066R1	1SDA102127R1
			25	XT2S 125 Ekip Dip LIG In25A	1SDA102067R1	1SDA102128R1
			60	XT2S 125 Ekip Dip LIG In60A	1SDA102068R1	1SDA102129R1
			100	XT2S 125 Ekip Dip LIG In100	1SDA102069R1	1SDA102130R1
			125	XT2S 125 Ekip Dip LIG In125	1SDA102070R1	1SDA102131R1

Distribution circuit-breakers



XT2 - circuit-breaker

SACE XT2H (65kA) TMF/TMA Front terminals (F)

Size	lu	Trip units	In	Type	3 poles	4 poles
					Code	Code
XT2	125	TMF	15	XT2H 125 TMF 15-400	1SDA074789R1	1SDA074803R1
			20	XT2H 125 TMF 20-400	1SDA074790R1	1SDA074804R1
			25	XT2H 125 TMF 25-400	1SDA074791R1	1SDA074805R1
			30	XT2H 125 TMF 30-400	1SDA074792R1	1SDA074806R1
			35	XT2H 125 TMF 35-400	1SDA074793R1	1SDA074807R1
			40	XT2H 125 TMF 40-400	1SDA074794R1	1SDA074808R1
			50	XT2H 125 TMF 50-500	1SDA074795R1	1SDA074809R1
			60	XT2H 125 TMF 60-600	1SDA074796R1	1SDA074810R1
XT2	125	TMA	70	XT2H 125 TMF 70-700	1SDA074797R1	1SDA074811R1
			80	XT2H 125 TMA 80-800	1SDA074798R1	1SDA074812R1
			90	XT2H 125 TMA 90-900	1SDA074799R1	1SDA074813R1
			100	XT2H 125 TMA 100-1000	1SDA074800R1	1SDA074814R1
			110	XT2H 125 TMA 110-1100	1SDA074801R1	1SDA074815R1
			125	XT2H 125 TMA 125-1250	1SDA074802R1	1SDA074816R1

SACE XT2H (65kA) Ekip LS/I Front terminals (F)

Size	lu	Trip units	In	Type	3 poles	4 poles
					Code	Code
XT2	125	Ekip LS/I	10	XT2H 125 Ekip LS/I In=10A	1SDA074920R1	1SDA074925R1
			25	XT2H 125 Ekip LS/I In=25A	1SDA074921R1	1SDA074926R1
			60	XT2H 125 Ekip LS/I In=60A	1SDA074922R1	1SDA074927R1
			100	XT2H 125 Ekip LS/I In=100A	1SDA074923R1	1SDA074928R1
			125	XT2H 125 Ekip LS/I In=125A	1SDA074924R1	1SDA074929R1

SACE XT2H (65kA) Ekip LSI Front terminals (F)

Size	lu	Trip units	In	Type	3 poles	4 poles
					Code	Code
XT2	125	Ekip LSI	10	XT2H 125 Ekip LSI In=10A	1SDA074970R1	1SDA074975R1
			25	XT2H 125 Ekip LSI In=25A	1SDA074971R1	1SDA074976R1
			60	XT2H 125 Ekip LSI In=60A	1SDA074972R1	1SDA074977R1
			100	XT2H 125 Ekip LSI In=100A	1SDA074973R1	1SDA074978R1
			125	XT2H 125 Ekip LSI In=125A	1SDA074974R1	1SDA074979R1

Ordering codes for XT2

Automatic circuit-breakers



XT2 - circuit-breaker

SACE XT2H (65kA) Ekip LSIG Front terminals (F)

Size	lu	Trip units	In	Type	3 poles	4 poles
					Code	Code
XT2	125	Ekip LSIG	10	XT2H 125 Ekip LSIG In=10A	1SDA075020R1	1SDA075025R1
			25	XT2H 125 Ekip LSIG In=25A	1SDA075021R1	1SDA075026R1
			60	XT2H 125 Ekip LSIG In=60A	1SDA075022R1	1SDA075027R1
			100	XT2H 125 Ekip LSIG In=100A	1SDA075023R1	1SDA075028R1
			125	XT2H 125 Ekip LSIG In=125A	1SDA075024R1	1SDA075029R1

SACE XT2H (65kA) Ekip Dip LIG Front terminals (F)

Size	lu	Trip units	In	Type	3 poles	4 poles
					Code	Code
XT2	125	Ekip LIG	10	XT2H 125 Ekip Dip LIG In10A	1SDA102085R1	1SDA102142R1
			25	XT2H 125 Ekip Dip LIG In25A	1SDA102086R1	1SDA102143R1
			60	XT2H 125 Ekip Dip LIG In60A	1SDA102087R1	1SDA102144R1
			100	XT2H 125 Ekip Dip LIG In100	1SDA102088R1	1SDA102145R1
			125	XT2H 125 Ekip Dip LIG In125	1SDA102089R1	1SDA102146R1

Motor protection circuit-breaker (MCP)

SACE XT2H (65kA) MA Front terminals (F)

Size	lu	Trip units	In	Type	3 poles	4 poles
					Code	Code
XT2	125	MA	3	XT2H 125 MA 3	1SDA074882R1	
			7	XT2H 125 MA 7	1SDA074883R1	
			15	XT2H 125 MA 15	1SDA074884R1	
			30	XT2H 125 MA 30	1SDA074885R1	
			50	XT2H 125 MA 50	1SDA074886R1	
			70	XT2H 125 MA 70	1SDA074887R1	
			80	XT2H 125 MA 80	1SDA074888R1	
			100	XT2H 125 MA 100	1SDA074889R1	
			125	XT2H 125 MA 125	1SDA074890R1	



XT2 - circuit-breaker

SACE XT2H (65kA) Ekip I Front terminals (F)

Size	lu	Trip units	In	Type	3 poles	4 poles
					Code	Code
XT2	125	Ekip I	10	XT2H 125 Ekip I In=10A	1SDA075070R1	
			25	XT2H 125 Ekip I In=25A	1SDA075071R1	
			60	XT2H 125 Ekip I In=60A	1SDA075072R1	
			100	XT2H 125 Ekip I In=100A	1SDA075073R1	
			125	XT2H 125 Ekip I In=125A	1SDA075074R1	

Motor protection circuit-breaker (MPCB)



XT2 - circuit-breaker

SACE XT2H (65kA) Ekip M-LIU Front terminals (F)

Size	Iu	Trip units	In	Type	3 poles	4 poles
					Code	Code
XT2	125	Ekip M-LIU	25	XT2H 125 Ekip M-LIU In=25A	1SDA075103R1	
			60	XT2H 125 Ekip M-LIU In=60A	1SDA075104R1	
			100	XT2H 125 Ekip M-LIU In=100A	1SDA075105R1	

SACE XT2H (65kA) Ekip M Touch LRIU Front terminals (F)

Size	Iu	Trip units	In	Type	3 poles	4 poles
					Code	Code
XT2	125	Ekip M Touch LRIU	40	XT2H 125 EkipM TouchLRIU 40	1SDA102090R1	
			60	XT2H 125 EkipM TouchLRIU 60	1SDA102091R1	
			100	XT2H 125 EkipM TouchLRIU 100	1SDA102092R1	

Ordering codes for XT2

Automatic circuit-breakers



XT2 - circuit-breaker

Distribution circuit-breakers

SACE XT2L (100kA) TMF/TMA Front terminals (F)

Size	lu	Trip units	In	Type	3 poles	4 poles
					Code	Code
XT2	125	TMF	15	XT2L 125 TMF 15-400	1SDA074817R1	1SDA074831R1
			20	XT2L 125 TMF 20-400	1SDA074818R1	1SDA074832R1
			25	XT2L 125 TMF 25-400	1SDA074819R1	1SDA074833R1
			30	XT2L 125 TMF 30-400	1SDA074820R1	1SDA074834R1
			35	XT2L 125 TMF 35-400	1SDA074821R1	1SDA074835R1
			40	XT2L 125 TMF 40-400	1SDA074822R1	1SDA074836R1
			50	XT2L 125 TMF 50-500	1SDA074823R1	1SDA074837R1
			60	XT2L 125 TMF 60-600	1SDA074824R1	1SDA074838R1
XT2	125	TMA	70	XT2L 125 TMF 70-700	1SDA074825R1	1SDA074839R1
			80	XT2L 125 TMA 80-800	1SDA074826R1	1SDA074840R1
			90	XT2L 125 TMA 90-900	1SDA074827R1	1SDA074841R1
			100	XT2L 125 TMA 100-1000	1SDA074828R1	1SDA074842R1
			110	XT2L 125 TMA 110-1100	1SDA074829R1	1SDA074843R1
			125	XT2L 125 TMA 125-1250	1SDA074830R1	1SDA074844R1

SACE XT2L (100kA) Ekip LS/I Front terminals (F)

Size	lu	Trip units	In	Type	3 poles	4 poles
					Code	Code
XT2	125	Ekip LS/I	10	XT2L 125 Ekip LS/I In=10A	1SDA074930R1	1SDA074935R1
			25	XT2L 125 Ekip LS/I In=25A	1SDA074931R1	1SDA074936R1
			60	XT2L 125 Ekip LS/I In=60A	1SDA074932R1	1SDA074937R1
			100	XT2L 125 Ekip LS/I In=100A	1SDA074933R1	1SDA074938R1
			125	XT2L 125 Ekip LS/I In=125A	1SDA074934R1	1SDA074939R1

SACE XT2L (100kA) Ekip LSI Front terminals (F)

Size	lu	Trip units	In	Type	3 poles	4 poles
					Code	Code
XT2	125	Ekip LSI	10	XT2L 125 Ekip LSI In=10A	1SDA074980R1	1SDA074985R1
			25	XT2L 125 Ekip LSI In=25A	1SDA074981R1	1SDA074986R1
			60	XT2L 125 Ekip LSI In=60A	1SDA074982R1	1SDA074987R1
			100	XT2L 125 Ekip LSI In=100A	1SDA074983R1	1SDA074988R1
			125	XT2L 125 Ekip LSI In=125A	1SDA074984R1	1SDA074989R1

SACE XT2L (100kA) Ekip LSIG Front terminals (F)

Size	lu	Trip units	In	Type	3 poles	4 poles
					Code	Code
XT2	125	Ekip LSIG	10	XT2L 125 Ekip LSIG In=10A	1SDA075030R1	1SDA075035R1
			25	XT2L 125 Ekip LSIG In=25A	1SDA075031R1	1SDA075036R1
			60	XT2L 125 Ekip LSIG In=60A	1SDA075032R1	1SDA075037R1
			100	XT2L 125 Ekip LSIG In=100A	1SDA075033R1	1SDA075038R1
			125	XT2L 125 Ekip LSIG In=125A	1SDA075034R1	1SDA075039R1

Motor protection circuit-breaker (MCP)

SACE XT2L (100kA) MA Front terminals (F)

Size	lu	Trip units	In	Type	3 poles	4 poles
					Code	Code
XT2	125	MA	3	XT2L 125 MA 3	1SDA074891R1	
			7	XT2L 125 MA 7	1SDA074892R1	
			15	XT2L 125 MA 15	1SDA074893R1	
			30	XT2L 125 MA 30	1SDA074894R1	
			50	XT2L 125 MA 50	1SDA074895R1	
			70	XT2L 125 MA 70	1SDA074896R1	
			80	XT2L 125 MA 80	1SDA074897R1	
			100	XT2L 125 MA 100	1SDA074898R1	
		125	XT2L 125 MA 125	1SDA074899R1		



XT2 - circuit-breaker

SACE XT2L (100kA) Ekip I Front terminals (F)

Size	lu	Trip units	In	Type	3 poles	4 poles
					Code	Code
XT2	125	Ekip I	10	XT2L 125 Ekip I In=10A	1SDA075080R1	
			25	XT2L 125 Ekip I In=25A	1SDA075081R1	
			60	XT2L 125 Ekip I In=60A	1SDA075082R1	
			100	XT2L 125 Ekip I In=100A	1SDA075083R1	
			125	XT2L 125 Ekip I In=125A	1SDA075084R1	

Ordering codes for XT2

Automatic circuit-breakers



—
XT2 - circuit-breaker

Motor protection circuit-breaker (MPCB)

SACE XT2L (100kA) Ekip M-LIU Front terminals (F)

Size	Iu	Trip units	In	Type	3 poles	4 poles
					Code	Code
XT2	125	Ekip M-LIU	25	XT2L 125 Ekip M-LIU In=25A	1SDA075106R1	
			60	XT2L 125 Ekip M-LIU In=60A	1SDA075107R1	
			100	XT2L 125 Ekip M-LIU In=100A	1SDA075108R1	

SACE XT2L (100kA) Ekip M Touch LRIU Front terminals (F)

Size	Iu	Trip units	In	Type	3 poles	4 poles
					Code	Code
XT2	125	Ekip M Touch LRIU	40	XT2L 125 EkipM TouchLRIU 40	1SDA102094R1	
			60	XT2L 125 EkipM TouchLRIU 60	1SDA102095R1	
			100	XT2L 125 EkipMTouchLRIU 100	1SDA102096R1	

Distribution circuit-breakers

—
XT2 - circuit-breaker**SACE XT2V (150kA) TMF/TMA Front terminals (F)**

Size	Iu	Trip units	In	Type	3 poles	4 poles
					Code	Code
XT2	125	TMF	15	XT2V 125 TMF 15-400	1SDA074845R1	1SDA074859R1
			20	XT2V 125 TMF 20-400	1SDA074846R1	1SDA074860R1
			25	XT2V 125 TMF 25-400	1SDA074847R1	1SDA074861R1
			30	XT2V 125 TMF 30-400	1SDA074848R1	1SDA074862R1
			35	XT2V 125 TMF 35-400	1SDA074849R1	1SDA074863R1
			40	XT2V 125 TMF 40-400	1SDA074850R1	1SDA074864R1
			50	XT2V 125 TMF 50-500	1SDA074851R1	1SDA074865R1
			60	XT2V 125 TMF 60-600	1SDA074852R1	1SDA074866R1
XT2	125	TMA	70	XT2V 125 TMF 70-700	1SDA074853R1	1SDA074867R1
			80	XT2V 125 TMA 80-800	1SDA074854R1	1SDA074868R1
			90	XT2V 125 TMA 90-900	1SDA074855R1	1SDA074869R1
			100	XT2V 125 TMA 100-1000	1SDA074856R1	1SDA074870R1
			110	XT2V 125 TMA 110-1100	1SDA074857R1	1SDA074871R1
			125	XT2V 125 TMA 125-1250	1SDA074858R1	1SDA074872R1

SACE XT2V (150kA) Ekip LS/I Front terminals (F)

Size	Iu	Trip units	In	Type	3 poles	4 poles
					Code	Code
XT2	125	Ekip LS/I	10	XT2V 125 Ekip LS/I In=10A	1SDA074940R1	1SDA074945R1
			25	XT2V 125 Ekip LS/I In=25A	1SDA074941R1	1SDA074946R1
			60	XT2V 125 Ekip LS/I In=60A	1SDA074942R1	1SDA074947R1
			100	XT2V 125 Ekip LS/I In=100A	1SDA074943R1	1SDA074948R1
			125	XT2V 125 Ekip LS/I In=125A	1SDA074944R1	1SDA074949R1

SACE XT2V (150kA) Ekip LSI Front terminals (F)

Size	Iu	Trip units	In	Type	3 poles	4 poles
					Code	Code
XT2	125	Ekip LSI	10	XT2V 125 Ekip LSI In=10A	1SDA074990R1	1SDA074995R1
			25	XT2V 125 Ekip LSI In=25A	1SDA074991R1	1SDA074996R1
			60	XT2V 125 Ekip LSI In=60A	1SDA074992R1	1SDA074997R1
			100	XT2V 125 Ekip LSI In=100A	1SDA074993R1	1SDA074998R1
			125	XT2V 125 Ekip LSI In=125A	1SDA074994R1	1SDA074999R1

Ordering codes for XT2

Automatic circuit-breakers



XT2 - circuit-breaker

SACE XT2V (150kA) Ekip LSIG Front terminals (F)

Size	lu	Trip units	In	Type	3 poles	4 poles
					Code	Code
XT2	125	Ekip LSIG	10	XT2V 125 Ekip LSIG In=10A	1SDA075040R1	1SDA075045R1
			25	XT2V 125 Ekip LSIG In=25A	1SDA075041R1	1SDA075046R1
			60	XT2V 125 Ekip LSIG In=60A	1SDA075042R1	1SDA075047R1
			100	XT2V 125 Ekip LSIG In=100A	1SDA075043R1	1SDA075048R1
			125	XT2V 125 Ekip LSIG In=125A	1SDA075044R1	1SDA075049R1

Motor protection circuit-breaker (MCP)

SACE XT2V (150kA) Ekip I Front terminals (F)

Size	lu	Trip units	In	Type	3 poles	4 poles
					Code	Code
XT2	125	Ekip I	10	XT2V 125 Ekip I In=10A	1SDA075090R1	
			25	XT2V 125 Ekip I In=25A	1SDA075091R1	
			60	XT2V 125 Ekip I In=60A	1SDA075092R1	
			100	XT2V 125 Ekip I In=100A	1SDA075093R1	
			125	XT2V 125 Ekip I In=125A	1SDA075094R1	

Motor protection circuit-breaker (MPCB)

SACE XT2V (150kA) Ekip M-LIU Front terminals (F)

Size	lu	Trip units	In	Type	3 poles	4 poles
					Code	Code
XT2	125	Ekip M-LIU	25	XT2V 125 Ekip M-LIU In=25A	1SDA075100R1	
			60	XT2V 125 Ekip M-LIU In=60A	1SDA075101R1	
			100	XT2V 125 Ekip M-LIU In=100A	1SDA075102R1	

SACE XT2V (150kA) Ekip M Touch LRIU Front terminals (F)

Size	lu	Trip units	In	Type	3 poles	4 poles
					Code	Code
XT2	125	Ekip M Touch LRIU	40	XT2V 125 EkipM TouchLRIU 40	1SDA102098R1	
			60	XT2V 125 EkipM TouchLRIU 60	1SDA102099R1	
			100	XT2V 125 EkipM TouchLRIU 100	1SDA102100R1	

Distribution circuit-breakers



XT2 - circuit-breaker

SACE XT2X (200kA) TMF/TMA Front terminals (F)

Size	lu	Trip units	In	Type	3 poles	4 poles
					Code	Code
XT2	125	TMF	15	XT2X 125 TMF 15-400	1SDA081937R1	1SDA081938R1
			20	XT2X 125 TMF 20-400	1SDA081939R1	1SDA081940R1
			25	XT2X 125 TMF 25-400	1SDA081941R1	1SDA081942R1
			30	XT2X 125 TMF 30-400	1SDA081943R1	1SDA081944R1
			35	XT2X 125 TMF 35-400	1SDA081945R1	1SDA081946R1
			40	XT2X 125 TMF 40-400	1SDA081947R1	1SDA081948R1
			50	XT2X 125 TMF 50-500	1SDA081949R1	1SDA081950R1
			60	XT2X 125 TMF 60-600	1SDA081951R1	1SDA081952R1
XT2	125	TMA	70	XT2X 125 TMF 70-700	1SDA081953R1	1SDA081954R1
			80	XT2X 125 TMA 80-800	1SDA081933R1	1SDA081934R1
			90	XT2X 125 TMA 90-900	1SDA081935R1	1SDA081936R1
			100	XT2X 125 TMA 100-1000	1SDA081927R1	1SDA081928R1
			110	XT2X 125 TMA 110-1100	1SDA081929R1	1SDA081930R1
			125	XT2X 125 TMA 125-1250	1SDA081931R1	1SDA081932R1

Molded case switches

SACE XT2D - MCS

Size	lu	Type	3 poles	4 poles
			Code	Code
XT2	125	XT2N-D 125	1SDA076617R1	1SDA076618R1
		XT2H-D 125	1SDA076619R1	1SDA076620R1
		XT2L-D 125	1SDA076621R1	1SDA076622R1
		XT2V-D 125	1SDA076623R1	1SDA076624R1

Ordering codes for XT2

Breaking part



XT2 - breaking part

SACE XT2 - Breaking part

Size	lu	Icu (415V)	Type	3 poles	4 poles
				Code	Code
XT2	125	25	XT2N 125 BREAKING PART	1SDA075630R1	1SDA075635R1
		35	XT2S 125 BREAKING PART	1SDA075631R1	1SDA075636R1
		65	XT2H 125 BREAKING PART	1SDA075632R1	1SDA075637R1
		100	XT2L 125 BREAKING PART	1SDA075633R1	1SDA075638R1
		150	XT2V 125 BREAKING PART	1SDA075634R1	1SDA075639R1

100% rated distribution circuit-breakers

100% rated version extra code

Size	3 poles	4 poles
	Code	Code
XT2	1SDA076604R1	1SDA080699R1

Note: to be specified only in addition to the code of the automatic circuit-breaker or of the breaking part

Ordering codes for XT2

Trip units

Trip units - distribution protection

Size	Type	3 poles	4 poles
		Code	Code
XT2	TMF 50-500	1SDA075650R1	1SDA075658R1
	TMF 60-600	1SDA075651R1	1SDA075659R1
	TMF 70-700	1SDA075652R1	1SDA075661R1
	TMA 80-800	1SDA075653R1	1SDA075662R1
	TMA 90-900	1SDA075654R1	1SDA075663R1
	TMA 100-1000	1SDA075655R1	1SDA075664R1
	TMA 110-1100	1SDA075656R1	1SDA075665R1
	TMA 125-1250	1SDA075657R1	1SDA075666R1
	Ekip LS/I In=60A	1SDA075672R1	1SDA075675R1
	Ekip LS/I In=100A	1SDA075673R1	1SDA075676R1
	Ekip LS/I In=125A	1SDA075674R1	1SDA075677R1
	Ekip LSI In=60A	1SDA075678R1	1SDA075681R1
	Ekip LSI In=100A	1SDA075679R1	1SDA075682R1
	Ekip LSI In=125A	1SDA075680R1	1SDA075683R1
	Ekip LSIG In=60A	1SDA075684R1	1SDA075687R1
	Ekip LSIG In=100A	1SDA075685R1	1SDA075688R1
	Ekip LSIG In=125A	1SDA075686R1	1SDA075689R1
	Ekip Dip LIG In=60A	1SDA102188R1	1SDA102230R1
	Ekip Dip LIG In=100A	1SDA102189R1	1SDA102231R1
	Ekip Dip LIG In=125A	1SDA102190R1	1SDA102232R1
	Ekip Touch LSI In=40A	1SDA102159R1	1SDA102205R1
	Ekip Touch LSI In=60A	1SDA102160R1	1SDA102206R1
	Ekip Touch LSI In=100A	1SDA102161R1	1SDA102207R1
	Ekip Touch LSI In=125A	1SDA102162R1	1SDA102208R1
	Ekip Touch LSIG In=40A	1SDA102163R1	1SDA102209R1
	Ekip Touch LSIG In=60A	1SDA102164R1	1SDA102210R1
	Ekip Touch LSIG In=100A	1SDA102165R1	1SDA102211R1
	Ekip Touch LSIG In=125A	1SDA102166R1	1SDA102212R1
	Ekip Touch Measuring LSI In=40A	1SDA102167R1	1SDA102213R1
	Ekip Touch Measuring LSI In=60A	1SDA102168R1	1SDA102214R1
	Ekip Touch Measuring LSI In=100A	1SDA102169R1	1SDA102215R1
	Ekip Touch Measuring LSI In=125A	1SDA102170R1	1SDA102216R1
	Ekip Touch Measuring LSIG In=40A	1SDA102171R1	1SDA102217R1
	Ekip Touch Measuring LSIG In=60A	1SDA102172R1	1SDA102218R1
	Ekip Touch Measuring LSIG In=100A	1SDA102173R1	1SDA102219R1
	Ekip Touch Measuring LSIG In=125A	1SDA102174R1	1SDA102220R1
	Ekip Hi-Touch LSI In=40A	1SDA102175R1	1SDA102221R1
	Ekip Hi-Touch LSI In=60A	1SDA102176R1	1SDA102222R1
	Ekip Hi-Touch LSI In=100A	1SDA102177R1	1SDA102223R1
	Ekip Hi-Touch LSI In=125A	1SDA102178R1	1SDA102224R1
	Ekip Hi-Touch LSIG In=40A	1SDA102179R1	1SDA102225R1
	Ekip Hi-Touch LSIG In=60A	1SDA102180R1	1SDA102226R1
Ekip Hi-Touch LSIG In=100A	1SDA102181R1	1SDA102227R1	
Ekip Hi-Touch LSIG In=125A	1SDA102182R1	1SDA102228R1	



Thermal magnetic trip unit



Dip trip unit



Touch trip unit

Ordering codes for XT2

Breaking part + trip unit solution



XT2 - breaking part



TMA trip unit



Ekip Dip trip unit



Ekip Touch trip unit

Breaking Part	Icu Poles	N (25kA)	S (35kA)	H (65kA)	L (100kA)	V (150kA)
		3	1SDA075630R1	1SDA075631R1	1SDA075632R1	1SDA075633R1
	4	1SDA075635R1	1SDA075636R1	1SDA075637R1	1SDA075638R1	1SDA075639R1

Trip units	In Poles	40	50	60	70	80	90	100	110	125
		TMF	3		1SDA075650R1	1SDA075651R1	1SDA075652R1			
	4		1SDA075658R1	1SDA075659R1	1SDA075661R1					
TMA	3					1SDA075653R1	1SDA075654R1	1SDA075655R1	1SDA075656R1	1SDA075657R1
	4					1SDA075662R1	1SDA075663R1	1SDA075664R1	1SDA075665R1	1SDA075666R1
Ekip LS/l	3			1SDA075672R1				1SDA075673R1		1SDA075674R1
	4			1SDA075675R1				1SDA075676R1		1SDA075677R1
Ekip LSI	3			1SDA075678R1				1SDA075679R1		1SDA075680R1
	4			1SDA075681R1				1SDA075682R1		1SDA075683R1
Ekip LSIG	3			1SDA075684R1				1SDA075685R1		1SDA075686R1
	4			1SDA075687R1				1SDA075688R1		1SDA075689R1
Ekip Dip LIG	3			1SDA102188R1				1SDA102189R1		1SDA102190R1
	4			1SDA102230R1				1SDA102231R1		1SDA102232R1
Ekip Touch LSI	3	1SDA102159R1		1SDA102160R1				1SDA102161R1		1SDA102162R1
	4	1SDA102205R1		1SDA102206R1				1SDA102207R1		1SDA102208R1
Ekip Touch LSIG	3	1SDA102163R1		1SDA102164R1				1SDA102165R1		1SDA102166R1
	4	1SDA102209R1		1SDA102210R1				1SDA102211R1		1SDA102212R1
Ekip Touch Measuring LSI	3	1SDA102167R1		1SDA102168R1				1SDA102169R1		1SDA102170R1
	4	1SDA102213R1		1SDA102214R1				1SDA102215R1		1SDA102216R1
Ekip Touch Measuring LSIG	3	1SDA102171R1		1SDA102172R1				1SDA102173R1		1SDA102174R1
	4	1SDA102217R1		1SDA102218R1				1SDA102219R1		1SDA102220R1
Ekip Hi-Touch LSI	3	1SDA102175R1		1SDA102176R1				1SDA102177R1		1SDA102178R1
	4	1SDA102221R1		1SDA102222R1				1SDA102223R1		1SDA102224R1
Ekip Hi-Touch LSIG	3	1SDA102179R1		1SDA102180R1				1SDA102181R1		1SDA102182R1
	4	1SDA102225R1		1SDA102226R1				1SDA102227R1		1SDA102228R1

Note: When a single code for the complete circuit-breaker is not available, please configure the breaking part code with the trip unit code to order a factory-assembled circuit-breaker

Ordering codes for XT3

Automatic circuit-breakers

Distribution circuit-breakers



XT3 - circuit-breaker

SACE XT3N (25kA) TMF Front terminals (F)

Size	lu	Trip units	In	Type	3 poles	4 poles
					Code	Code
XT3	225	TMF	60	XT3N 225 TMF 60-600	1SDA075109R1	1SDA075119R1
			70	XT3N 225 TMF 70-700	1SDA075110R1	1SDA075120R1
			80	XT3N 225 TMF 80-800	1SDA075111R1	1SDA075121R1
			90	XT3N 225 TMF 90-900	1SDA075112R1	1SDA075122R1
			100	XT3N 225 TMF 100-1000	1SDA075113R1	1SDA075123R1
			110	XT3N 225 TMF 110-1100	1SDA080071R1	1SDA080072R1
			125	XT3N 225 TMF 125-1250	1SDA075114R1	1SDA075124R1
			150	XT3N 225 TMF 150-1500	1SDA075115R1	1SDA075125R1
			175	XT3N 225 TMF 175-1750	1SDA075116R1	1SDA075126R1
			200	XT3N 225 TMF 200-2000	1SDA075117R1	1SDA075127R1
			225	XT3N 225 TMF 225-2250	1SDA075118R1	1SDA075128R1

SACE XT3S (35kA) TMF Front terminals (F)

Size	lu	Trip units	In	Type	3 poles	4 poles
					Code	Code
XT3	225	TMF	60	XT3S 225 TMF 60-600	1SDA075129R1	1SDA075139R1
			70	XT3S 225 TMF 70-700	1SDA075130R1	1SDA075140R1
			80	XT3S 225 TMF 80-800	1SDA075131R1	1SDA075141R1
			90	XT3S 225 TMF 90-900	1SDA075132R1	1SDA075142R1
			100	XT3S 225 TMF 100-1000	1SDA075133R1	1SDA075143R1
			110	XT3S 225 TMF 110-1100	1SDA080073R1	1SDA080074R1
			125	XT3S 225 TMF 125-1250	1SDA075134R1	1SDA075144R1
			150	XT3S 225 TMF 150-1500	1SDA075135R1	1SDA075145R1
			175	XT3S 225 TMF 175-1750	1SDA075136R1	1SDA075146R1
			200	XT3S 225 TMF 200-2000	1SDA075137R1	1SDA075147R1
			225	XT3S 225 TMF 225-2250	1SDA075138R1	1SDA075148R1

Ordering codes for XT3

Automatic circuit-breakers



XT3 - circuit-breaker

Motor protection circuit-breaker (MCP)

SACE XT3S (35kA) MA Front terminals (F)

Size	Iu	Trip units	In	Type	3 poles	4 poles
					Code	Code
XT3	225	MA	100	XT3S 225 MA 100	1SDA075149R1	
			110	XT3S 225 MA 110	1SDA076600R1	
			125	XT3S 225 MA 125	1SDA075150R1	
			150	XT3S 225 MA 150	1SDA075151R1	
			200	XT3S 225 MA 200	1SDA075152R1	

Molded case switches

SACE XT3D - MCS

Size	Iu	Type	3 poles	4 poles
			Code	Code
XT3	225	XT3N-D 225	1SDA075616R1	1SDA075617R1
		XT3S-D 225	1SDA075618R1	1SDA075619R1

100% rated distribution circuit-breakers

100% rated version extra code

Size	3 poles	4 poles
	Code	Code
XT3	1SDA076605R1	1SDA080700R1

Note: to be specified only in addition to the code of the automatic circuit-breaker

Ordering codes for XT4

Automatic circuit-breakers

Distribution circuit-breakers



XT4 - circuit-breaker

SACE XT4N (25kA) TMF/TMA Front terminals (F)

Size	lu	Trip units	In	Type	2 poles	3 poles	4 poles
					Code	Code	Code
XT4	250	TMF	25	XT4N 250 TMF 25-400	1SDA080117R1	1SDA075153R1	1SDA075170R1
			30	XT4N 250 TMF 30-400	1SDA080128R1	1SDA075154R1	1SDA075171R1
			35	XT4N 250 TMF 35-400	1SDA080129R1	1SDA075155R1	1SDA075173R1
			40	XT4N 250 TMF 40-400	1SDA080130R1	1SDA075156R1	1SDA075174R1
			50	XT4N 250 TMF 50-500	1SDA080131R1	1SDA075157R1	1SDA075175R1
			60	XT4N 250 TMF 60-600	1SDA080132R1	1SDA075158R1	1SDA075176R1
			70	XT4N 250 TMF 70-700	1SDA080133R1	1SDA075159R1	1SDA075177R1
			80	XT4N 250 TMF 80-800		1SDA080135R1	
			90	XT4N 250 TMF 90-900		1SDA080137R1	
			100	XT4N 250 TMF 100-1000		1SDA080102R1	
			110	XT4N 250 TMF 110-1100		1SDA080104R1	
			125	XT4N 250 TMF 125-1250		1SDA080106R1	
			150	XT4N 250 TMF 150-1500		1SDA080108R1	
			175	XT4N 250 TMF 175-1750		1SDA080110R1	
			200	XT4N 250 TMF 200-2000		1SDA080112R1	
			225	XT4N 250 TMF 225-2250		1SDA080114R1	
			250	XT4N 250 TMF 250-2500		1SDA080116R1	
XT4	250	TMA	80	XT4N 250 TMA 80-800	1SDA080134R1	1SDA075160R1	1SDA075178R1
			90	XT4N 250 TMA 90-900	1SDA080136R1	1SDA075161R1	1SDA075179R1
			100	XT4N 250 TMA 100-1000	1SDA080101R1	1SDA075162R1	1SDA075180R1
			110	XT4N 250 TMA 110-1100	1SDA080103R1	1SDA075163R1	1SDA075181R1
			125	XT4N 250 TMA 125-1250	1SDA080105R1	1SDA075164R1	1SDA075182R1
			150	XT4N 250 TMA 150-1500	1SDA080107R1	1SDA075165R1	1SDA075183R1
			175	XT4N 250 TMA 175-1750	1SDA080109R1	1SDA075166R1	1SDA075184R1
			200	XT4N 250 TMA 200-2000	1SDA080111R1	1SDA075167R1	1SDA075185R1
			225	XT4N 250 TMA 225-2250	1SDA080113R1	1SDA075168R1	1SDA075186R1
			250	XT4N 250 TMA 250-2500	1SDA080115R1	1SDA075169R1	1SDA075187R1

SACE XT4N (25kA) Ekip LS/I Front terminals (F)

Size	lu	Trip units	In	Type	3 poles	4 poles
					Code	Code
XT4	250	Ekip LS/I	40	XT4N 250 Ekip LS/I In=40A	1SDA075358R1	1SDA075364R1
			60	XT4N 250 Ekip LS/I In=60A	1SDA075359R1	1SDA075365R1
			100	XT4N 250 Ekip LS/I In=100A	1SDA075360R1	1SDA075366R1
			150	XT4N 250 Ekip LS/I In=150A	1SDA075361R1	1SDA075367R1
			225	XT4N 250 Ekip LS/I In=225A	1SDA075362R1	1SDA075368R1
			250	XT4N 250 Ekip LS/I In=250A	1SDA075363R1	1SDA075369R1

Ordering codes for XT4

Automatic circuit-breakers



XT4 - circuit-breaker

SACE XT4N (25kA) Ekip LSI Front terminals (F)

Size	lu	Trip units	In	Type	3 poles	4 poles
					Code	Code
XT4	250	Ekip LSI	40	XT4N 250 Ekip LSI In=40A	1SDA075418R1	1SDA075424R1
			60	XT4N 250 Ekip LSI In=60A	1SDA075419R1	1SDA075425R1
			100	XT4N 250 Ekip LSI In=100A	1SDA075420R1	1SDA075426R1
			150	XT4N 250 Ekip LSI In=150A	1SDA075421R1	1SDA075427R1
			225	XT4N 250 Ekip LSI In=225A	1SDA075422R1	1SDA075428R1
			250	XT4N 250 Ekip LSI In=250A	1SDA075423R1	1SDA075429R1

SACE XT4N (25kA) Ekip LSI Front terminals (F)

Size	lu	Trip units	In	Type	3 poles	4 poles
					Code	Code
XT4	250	Ekip LSI	40	XT4N 250 Ekip LSI In=40A	1SDA075478R1	1SDA075484R1
			60	XT4N 250 Ekip LSI In=60A	1SDA075479R1	1SDA075485R1
			100	XT4N 250 Ekip LSI In=100A	1SDA075480R1	1SDA075486R1
			150	XT4N 250 Ekip LSI In=150A	1SDA075481R1	1SDA075487R1
			225	XT4N 250 Ekip LSI In=225A	1SDA075482R1	1SDA075488R1
			250	XT4N 250 Ekip LSI In=250A	1SDA075483R1	1SDA075489R1

SACE XT4N (25kA) Ekip Dip LIG Front terminals (F)

Size	lu	Trip units	In	Type	3 poles	4 poles
					Code	Code
XT4	250	Ekip Dip LIG	40	XT4N 250 Ekip Dip LIG In=40A	1SDA102247R1	1SDA102311R1
			60	XT4N 250 Ekip Dip LIG In=60A	1SDA102248R1	1SDA102312R1
			100	XT4N 250 Ekip Dip LIG In=100A	1SDA102249R1	1SDA102313R1
			150	XT4N 250 Ekip Dip LIG In=150A	1SDA102250R1	1SDA102314R1
			225	XT4N 250 Ekip Dip LIG In=225A	1SDA102251R1	1SDA102310R1
			250	XT4N 250 Ekip Dip LIG In=250A	1SDA102252R1	1SDA102315R1

Distribution circuit-breakers



XT4 - circuit-breaker

SACE XT4S (35kA) TMF/TMA Front terminals (F)

Size	lu	Trip units	In	Type	3 poles	4 poles
					Code	Code
XT4	250	TMF	25	XT4S 250 TMF 25-400	1SDA075188R1	1SDA075205R1
			30	XT4S 250 TMF 30-400	1SDA075189R1	1SDA075206R1
			35	XT4S 250 TMF 35-400	1SDA075190R1	1SDA075208R1
			40	XT4S 250 TMF 40-400	1SDA075191R1	1SDA075209R1
			50	XT4S 250 TMF 50-500	1SDA075192R1	1SDA075210R1
			60	XT4S 250 TMF 60-600	1SDA075193R1	1SDA075211R1
			70	XT4S 250 TMF 70-700	1SDA075194R1	1SDA075212R1
			80	XT4S 250 TMF 80-800	1SDA080148R1	
			90	XT4S 250 TMF 90-900	1SDA080149R1	
			100	XT4S 250 TMF 100-1000	1SDA080140R1	
			110	XT4S 250 TMF 110-1100	1SDA080141R1	
			125	XT4S 250 TMF 125-1250	1SDA080142R1	
			150	XT4S 250 TMF 150-1500	1SDA080143R1	
			175	XT4S 250 TMF 175-1750	1SDA080144R1	
			200	XT4S 250 TMF 200-2000	1SDA080145R1	
			XT4	250	TMA	225
250	XT4S 250 TMF 250-2500	1SDA080147R1				
80	XT4S 250 TMA 80-800	1SDA075195R1				1SDA075213R1
90	XT4S 250 TMA 90-900	1SDA075196R1				1SDA075214R1
100	XT4S 250 TMA 100-1000	1SDA075197R1				1SDA075215R1
110	XT4S 250 TMA 110-1100	1SDA075198R1				1SDA075216R1
125	XT4S 250 TMA 125-1250	1SDA075199R1				1SDA075217R1
150	XT4S 250 TMA 150-1500	1SDA075200R1				1SDA075218R1
175	XT4S 250 TMA 175-1750	1SDA075201R1	1SDA075219R1			
200	XT4S 250 TMA 200-2000	1SDA075202R1	1SDA075220R1			
225	XT4S 250 TMA 225-2250	1SDA075203R1	1SDA075221R1			
250	XT4S 250 TMA 250-2500	1SDA075204R1	1SDA075222R1			

SACE XT4S (35kA) Ekip LS/I Front terminals (F)

Size	lu	Trip units	In	Type	3 poles	4 poles
					Code	Code
XT4	250	Ekip LS/I	40	XT4S 250 Ekip LS/I In=40A	1SDA075370R1	1SDA075376R1
			60	XT4S 250 Ekip LS/I In=60A	1SDA075371R1	1SDA075377R1
			100	XT4S 250 Ekip LS/I In=100A	1SDA075372R1	1SDA075378R1
			150	XT4S 250 Ekip LS/I In=150A	1SDA075373R1	1SDA075379R1
			225	XT4S 250 Ekip LS/I In=225A	1SDA075374R1	1SDA075380R1
			250	XT4S 250 Ekip LS/I In=250A	1SDA075375R1	1SDA075381R1

Ordering codes for XT4

Automatic circuit-breakers



XT4 - circuit-breaker

SACE XT4S (35kA) Ekip LSI Front terminals (F)

Size	lu	Trip units	In	Type	3 poles	4 poles
					Code	Code
XT4	250	Ekip LSI	40	XT4S 250 Ekip LSI In=40A	1SDA075430R1	1SDA075436R1
			60	XT4S 250 Ekip LSI In=60A	1SDA075431R1	1SDA075437R1
			100	XT4S 250 Ekip LSI In=100A	1SDA075432R1	1SDA075438R1
			150	XT4S 250 Ekip LSI In=150A	1SDA075433R1	1SDA075439R1
			225	XT4S 250 Ekip LSI In=225A	1SDA075434R1	1SDA075440R1
			250	XT4S 250 Ekip LSI In=250A	1SDA075435R1	1SDA075441R1

SACE XT4S (35kA) Ekip LSIG Front terminals (F)

Size	lu	Trip units	In	Type	3 poles	4 poles
					Code	Code
XT4	250	Ekip LSIG	40	XT4S 250 Ekip LSIG In=40A	1SDA075490R1	1SDA075496R1
			60	XT4S 250 Ekip LSIG In=60A	1SDA075491R1	1SDA075497R1
			100	XT4S 250 Ekip LSIG In=100A	1SDA075492R1	1SDA075498R1
			150	XT4S 250 Ekip LSIG In=150A	1SDA075493R1	1SDA075499R1
			225	XT4S 250 Ekip LSIG In=225A	1SDA075494R1	1SDA075500R1
			250	XT4S 250 Ekip LSIG In=250A	1SDA075495R1	1SDA075501R1

SACE XT4S (35kA) Ekip Dip LIG Front terminals (F)

Size	lu	Trip units	In	Type	3 poles	4 poles
					Code	Code
XT4	250	Ekip Dip LIG	40	XT4S 250 Ekip Dip LIG In=40A	1SDA102266R1	1SDA102326R1
			60	XT4S 250 Ekip Dip LIG In=60A	1SDA102267R1	1SDA102327R1
			100	XT4S 250 Ekip Dip LIG In=100A	1SDA102268R1	1SDA102328R1
			150	XT4S 250 Ekip Dip LIG In=150A	1SDA102269R1	1SDA102329R1
			225	XT4S 250 Ekip Dip LIG In=225A	1SDA102265R1	1SDA102325R1
			250	XT4S 250 Ekip Dip LIG In=250A	1SDA102270R1	1SDA102330R1

Distribution circuit-breakers



XT4 - circuit-breaker

SACE XT4H (65kA) TMF/TMA Front terminals (F)

Size	lu	Trip units	In	Type	3 poles	4 poles
					Code	Code
XT4	250	TMF	25	XT4H 250 TMF 25-400	1SDA075223R1	1SDA075240R1
			30	XT4H 250 TMF 30-400	1SDA075224R1	1SDA075241R1
			35	XT4H 250 TMF 35-400	1SDA075225R1	1SDA075242R1
			40	XT4H 250 TMF 40-400	1SDA075226R1	1SDA075243R1
			50	XT4H 250 TMF 50-500	1SDA075227R1	1SDA075244R1
			60	XT4H 250 TMF 60-600	1SDA075228R1	1SDA075245R1
			70	XT4H 250 TMF 70-700	1SDA075229R1	1SDA075246R1
			80	XT4H 250 TMF 80-800	1SDA080085R1	
			90	XT4H 250 TMF 90-900	1SDA080086R1	
			100	XT4H 250 TMF 100-1000	1SDA080077R1	
			110	XT4H 250 TMF 110-1100	1SDA080078R1	
			125	XT4H 250 TMF 125-1250	1SDA080079R1	
			150	XT4H 250 TMF 150-1500	1SDA080080R1	
			175	XT4H 250 TMF 175-1750	1SDA080081R1	
			200	XT4H 250 TMF 200-2000	1SDA080082R1	
			225	XT4H 250 TMF 225-2250	1SDA080083R1	
250	XT4H 250 TMF 250-2500	1SDA080084R1				
XT4	250	TMA	80	XT4H 250 TMA 80-800	1SDA075230R1	1SDA075247R1
			90	XT4H 250 TMA 90-900	1SDA075231R1	1SDA075248R1
			100	XT4H 250 TMA 100-1000	1SDA075232R1	1SDA075249R1
			110	XT4H 250 TMA 110-1100	1SDA075233R1	1SDA075250R1
			125	XT4H 250 TMA 125-1250	1SDA075234R1	1SDA075251R1
			150	XT4H 250 TMA 150-1500	1SDA075235R1	1SDA075252R1
			175	XT4H 250 TMA 175-1750	1SDA075236R1	1SDA075253R1
			200	XT4H 250 TMA 200-2000	1SDA075237R1	1SDA075254R1
			225	XT4H 250 TMA 225-2250	1SDA075238R1	1SDA075255R1
			250	XT4H 250 TMA 250-2500	1SDA075239R1	1SDA075256R1

SACE XT4H (65kA) Ekip LS/I Front terminals (F)

Size	lu	Trip units	In	Type	3 poles	4 poles
					Code	Code
XT4	250	Ekip LS/I	40	XT4H 250 Ekip LS/I In=40A	1SDA075394R1	1SDA075400R1
			60	XT4H 250 Ekip LS/I In=60A	1SDA075395R1	1SDA075401R1
			100	XT4H 250 Ekip LS/I In=100A	1SDA075396R1	1SDA075402R1
			150	XT4H 250 Ekip LS/I In=150A	1SDA075397R1	1SDA075403R1
			225	XT4H 250 Ekip LS/I In=225A	1SDA075398R1	1SDA075404R1
			250	XT4H 250 Ekip LS/I In=250A	1SDA075399R1	1SDA075405R1

Ordering codes for XT4

Automatic circuit-breakers



XT4 - circuit-breaker

SACE XT4H (65kA) Ekip LSI Front terminals (F)

Size	lu	Trip units	In	Type	3 poles	4 poles
					Code	Code
XT4	250	Ekip LSI	40	XT4H 250 Ekip LSI In=40A	1SDA075442R1	1SDA075448R1
			60	XT4H 250 Ekip LSI In=60A	1SDA075443R1	1SDA075449R1
			100	XT4H 250 Ekip LSI In=100A	1SDA075444R1	1SDA075450R1
			150	XT4H 250 Ekip LSI In=150A	1SDA075445R1	1SDA075451R1
			225	XT4H 250 Ekip LSI In=225A	1SDA075446R1	1SDA075452R1
			250	XT4H 250 Ekip LSI In=250A	1SDA075447R1	1SDA075453R1

SACE XT4H (65kA) Ekip LSI Front terminals (F)

Size	lu	Trip units	In	Type	3 poles	4 poles
					Code	Code
XT4	250	Ekip LSI	40	XT4H 250 Ekip LSI In=40A	1SDA075508R1	1SDA075502R1
			60	XT4H 250 Ekip LSI In=60A	1SDA075509R1	1SDA075503R1
			100	XT4H 250 Ekip LSI In=100A	1SDA075510R1	1SDA075504R1
			150	XT4H 250 Ekip LSI In=150A	1SDA075511R1	1SDA075505R1
			225	XT4H 250 Ekip LSI In=225A	1SDA075512R1	1SDA075506R1
			250	XT4H 250 Ekip LSI In=250A	1SDA075513R1	1SDA075507R1

SACE XT4H (65kA) Ekip Dip LIG Front terminals (F)

Size	lu	Trip units	In	Type	3 poles	4 poles
					Code	Code
XT4	250	Ekip Dip LIG	40	XT4H 250 Ekip Dip LIG In=40A	1SDA102284R1	1SDA102341R1
			60	XT4H 250 Ekip Dip LIG In=60A	1SDA102285R1	1SDA102342R1
			100	XT4H 250 Ekip Dip LIG In=100A	1SDA102286R1	1SDA102343R1
			150	XT4H 250 Ekip Dip LIG In=150A	1SDA102287R1	1SDA102344R1
			225	XT4H 250 Ekip Dip LIG In=225A	1SDA102283R1	1SDA102340R1
			250	XT4H 250 Ekip Dip LIG In=250A	1SDA102288R1	1SDA102345R1

Motor protection circuit-breaker (MCP)



XT4 - circuit-breaker

SACE XT4H (65kA) MA Front terminals (F)

Size	Iu	Trip units	In	Type	3 poles	4 poles
					Code	Code
XT4	250	MA	25	XT4H 250 MA 25	1SDA075336R1	
			50	XT4H 250 MA 50	1SDA075337R1	
			80	XT4H 250 MA 80	1SDA075338R1	
			100	XT4H 250 MA 100	1SDA075339R1	
			110	XT4H 250 MA 110	1SDA075340R1	
			125	XT4H 250 MA 125	1SDA075341R1	
			150	XT4H 250 MA 150	1SDA075342R1	
			175	XT4H 250 MA 175	1SDA075343R1	
			200	XT4H 250 MA 200	1SDA075344R1	
			225	XT4H 250 MA 225	1SDA075345R1	
			250	XT4H 250 MA 250	1SDA075346R1	

SACE XT4H (65kA) Ekip I Front terminals (F)

Size	Iu	Trip units	In	Type	3 poles	4 poles
					Code	Code
XT4	250	Ekip I	40	XT4H 250 Ekip I In=40A	1SDA075562R1	
			60	XT4H 250 Ekip I In=60A	1SDA075563R1	
			100	XT4H 250 Ekip I In=100A	1SDA075564R1	
			150	XT4H 250 Ekip I In=150A	1SDA075565R1	
			225	XT4H 250 Ekip I In=225A	1SDA075566R1	
			250	XT4H 250 Ekip I In=250A	1SDA075567R1	

Motor protection circuit-breaker (MPCB)



XT4 - circuit-breaker

SACE XT4H (65kA) Ekip M-LIU Front terminals (F)

Size	Iu	Trip units	In	Type	3 poles	4 poles
					Code	Code
XT4	250	Ekip M-LIU	40	XT4H 250 Ekip M-LIU In=40A	1SDA075602R1	
			60	XT4H 250 Ekip M-LIU In=60A	1SDA075603R1	
			100	XT4H 250 Ekip M-LIU In=100A	1SDA075604R1	
			150	XT4H 250 Ekip M-LIU In=150A	1SDA075605R1	

SACE XT4H (65kA) Ekip M Touch LRIU Front terminals (F)

Size	Iu	Trip units	In	Type	3 poles	4 poles
					Code	Code
XT4	250	Ekip M Touch LRIU	100	XT4H 250 EkipMTouchLRIU 100	1SDA102289R1	
			150	XT4H 250 EkipMTouchLRIU 150	1SDA102290R1	
			200	XT4H 250 EkipMTouchLRIU 200	1SDA102291R1	

Ordering codes for XT4

Automatic circuit-breakers

Distribution circuit-breakers

SACE XT4L (100kA) TMF/TMA Front terminals (F)



XT4 - circuit-breaker

Size	lu	Trip units	In	Type	3 poles	4 poles
					Code	Code
XT4	250	TMF	25	XT4L 250 TMF 25-400	1SDA075257R1	1SDA075274R1
			30	XT4L 250 TMF 30-400	1SDA075258R1	1SDA075275R1
			35	XT4L 250 TMF 35-400	1SDA075259R1	1SDA075276R1
			40	XT4L 250 TMF 40-400	1SDA075260R1	1SDA075277R1
			50	XT4L 250 TMF 50-500	1SDA075261R1	1SDA075278R1
			60	XT4L 250 TMF 60-600	1SDA075262R1	1SDA075279R1
			70	XT4L 250 TMF 70-700	1SDA075263R1	1SDA075280R1
			80	XT4L 250 TMF 80-800	1SDA080097R1	
			90	XT4L 250 TMF 90-900	1SDA080098R1	
			100	XT4L 250 TMF 100-1000	1SDA080089R1	
			110	XT4L 250 TMF 110-1100	1SDA080090R1	
			125	XT4L 250 TMF 125-1250	1SDA080091R1	
			150	XT4L 250 TMF 150-1500	1SDA080092R1	
			175	XT4L 250 TMF 175-1750	1SDA080093R1	
			200	XT4L 250 TMF 200-2000	1SDA080094R1	
			225	XT4L 250 TMF 225-2250	1SDA080095R1	
250	XT4L 250 TMF 250-2500	1SDA080096R1				
XT4	250	TMA	80	XT4L 250 TMA 80-800	1SDA075264R1	1SDA075281R1
			90	XT4L 250 TMA 90-900	1SDA075265R1	1SDA075282R1
			100	XT4L 250 TMA 100-1000	1SDA075266R1	1SDA075283R1
			110	XT4L 250 TMA 110-1100	1SDA075267R1	1SDA075284R1
			125	XT4L 250 TMA 125-1250	1SDA075268R1	1SDA075285R1
			150	XT4L 250 TMA 150-1500	1SDA075269R1	1SDA075286R1
			175	XT4L 250 TMA 175-1750	1SDA075270R1	1SDA075287R1
			200	XT4L 250 TMA 200-2000	1SDA075271R1	1SDA075288R1
			225	XT4L 250 TMA 225-2250	1SDA075272R1	1SDA075289R1
			250	XT4L 250 TMA 250-2500	1SDA075273R1	1SDA075290R1

SACE XT4L (100kA) Ekip LS/I Front terminals (F)

Size	lu	Trip units	In	Type	3 poles	4 poles
					Code	Code
XT4	250	Ekip LS/I	40	XT4L 250 Ekip LS/I In=40A	1SDA075382R1	1SDA075388R1
			60	XT4L 250 Ekip LS/I In=60A	1SDA075383R1	1SDA075389R1
			100	XT4L 250 Ekip LS/I In=100A	1SDA075384R1	1SDA075390R1
			150	XT4L 250 Ekip LS/I In=150A	1SDA075385R1	1SDA075391R1
			225	XT4L 250 Ekip LS/I In=225A	1SDA075386R1	1SDA075392R1
			250	XT4L 250 Ekip LS/I In=250A	1SDA075387R1	1SDA075393R1



XT4 - circuit-breaker

SACE XT4L (100kA) Ekip LSI Front terminals (F)

Size	Iu	Trip units	In	Type	3 poles	4 poles
					Code	Code
XT4	250	Ekip LSI	40	XT4L 250 Ekip LSI In=40A	1SDA075454R1	1SDA075460R1
			60	XT4L 250 Ekip LSI In=60A	1SDA075455R1	1SDA075461R1
			100	XT4L 250 Ekip LSI In=100A	1SDA075456R1	1SDA075462R1
			150	XT4L 250 Ekip LSI In=150A	1SDA075457R1	1SDA075463R1
			225	XT4L 250 Ekip LSI In=225A	1SDA075458R1	1SDA075464R1
			250	XT4L 250 Ekip LSI In=250A	1SDA075459R1	1SDA075465R1

SACE XT4L (100kA) Ekip LSIG Front terminals (F)

Size	Iu	Trip units	In	Type	3 poles	4 poles
					Code	Code
XT4	250	Ekip LSIG	40	XT4L 250 Ekip LSIG In=40A	1SDA075514R1	1SDA075520R1
			60	XT4L 250 Ekip LSIG In=60A	1SDA075515R1	1SDA075521R1
			100	XT4L 250 Ekip LSIG In=100A	1SDA075516R1	1SDA075522R1
			150	XT4L 250 Ekip LSIG In=150A	1SDA075517R1	1SDA075523R1
			225	XT4L 250 Ekip LSIG In=225A	1SDA075518R1	1SDA075524R1
			250	XT4L 250 Ekip LSIG In=250A	1SDA075519R1	1SDA075525R1

Ordering codes for XT4

Automatic circuit-breakers



XT4 - circuit-breaker

Motor protection circuit-breaker (MCP)

SACE XT4L (100kA) MA Front terminals (F)

Size	Iu	Trip units	In	Type	3 poles	4 poles
					Code	Code
XT4	250	MA	25	XT4L 250 MA 25	1SDA075347R1	
			50	XT4L 250 MA 50	1SDA075348R1	
			80	XT4L 250 MA 80	1SDA075349R1	
			100	XT4L 250 MA 100	1SDA075350R1	
			110	XT4L 250 MA 110	1SDA075351R1	
			125	XT4L 250 MA 125	1SDA075352R1	
			150	XT4L 250 MA 150	1SDA075353R1	
			175	XT4L 250 MA 175	1SDA075354R1	
			200	XT4L 250 MA 200	1SDA075355R1	
			225	XT4L 250 MA 225	1SDA075356R1	
			250	XT4L 250 MA 250	1SDA075357R1	

SACE XT4L (100kA) Ekip I Front terminals (F)

Size	Iu	Trip units	In	Type	3 poles	4 poles
					Code	Code
XT4	250	Ekip I	40	XT4L 250 Ekip I In=40A	1SDA075574R1	
			60	XT4L 250 Ekip I In=60A	1SDA075575R1	
			100	XT4L 250 Ekip I In=100A	1SDA075576R1	
			150	XT4L 250 Ekip I In=150A	1SDA075577R1	
			225	XT4L 250 Ekip I In=225A	1SDA075578R1	
			250	XT4L 250 Ekip I In=250A	1SDA075579R1	

Motor protection circuit-breaker (MPCB)

SACE XT4L (100kA) Ekip M-LIU Front terminals (F)

Size	Iu	Trip units	In	Type	3 poles	4 poles
					Code	Code
XT4	250	Ekip M-LIU	40	XT4L 250 Ekip M-LIU In=40A	1SDA075606R1	
			60	XT4L 250 Ekip M-LIU In=60A	1SDA075607R1	
			100	XT4L 250 Ekip M-LIU In=100A	1SDA075608R1	
			150	XT4L 250 Ekip M-LIU In=150A	1SDA075609R1	

SACE XT4L (100kA) Ekip M Touch LRIU Front terminals (F)

Size	Iu	Trip units	In	Type	3 poles	4 poles
					Code	Code
XT4	250	Ekip M Touch LRIU	100	XT4L 250 EkipMTouchLRIU 100	1SDA102292R1	
			150	XT4L 250 EkipMTouchLRIU 150	1SDA102293R1	
			200	XT4L 250 EkipMTouchLRIU 200	1SDA102294R1	



XT4 - circuit-breaker

Distribution circuit-breakers

SACE XT4V (150kA) TMF/TMA Front terminals (F)

XT4 - circuit-breaker

Size	lu	Trip units	In	Type	3 poles		4 poles	
					Code	Code	Code	Code
XT4	250	TMF	25	XT4V 250 TMF 25-400	1SDA075291R1		1SDA075308R1	
			30	XT4V 250 TMF 30-400	1SDA075292R1		1SDA075309R1	
			35	XT4V 250 TMF 35-400	1SDA075293R1		1SDA075310R1	
			40	XT4V 250 TMF 40-400	1SDA075294R1		1SDA075311R1	
			50	XT4V 250 TMF 50-500	1SDA075295R1		1SDA075312R1	
			60	XT4V 250 TMF 60-600	1SDA075296R1		1SDA075313R1	
			70	XT4V 250 TMF 70-700	1SDA075297R1		1SDA075314R1	
			80	XT4V 250 TMF 80-800	1SDA080160R1			
			90	XT4V 250 TMF 90-900	1SDA080161R1			
			100	XT4V 250 TMF 100-1000	1SDA080152R1			
			110	XT4V 250 TMF 110-1100	1SDA080153R1			
			125	XT4V 250 TMF 125-1250	1SDA080154R1			
			150	XT4V 250 TMF 150-1500	1SDA080155R1			
			175	XT4V 250 TMF 175-1750	1SDA080156R1			
			200	XT4V 250 TMF 200-2000	1SDA080157R1			
			225	XT4V 250 TMF 225-2250	1SDA080158R1			
			250	XT4V 250 TMF 250-2500	1SDA080159R1			
XT4	250	TMA	80	XT4V 250 TMA 80-800	1SDA075298R1		1SDA075315R1	
			90	XT4V 250 TMA 90-900	1SDA075299R1		1SDA075316R1	
			100	XT4V 250 TMA 100-1000	1SDA075300R1		1SDA075317R1	
			110	XT4V 250 TMA 110-1100	1SDA075301R1		1SDA075318R1	
			125	XT4V 250 TMA 125-1250	1SDA075302R1		1SDA075319R1	
			150	XT4V 250 TMA 150-1500	1SDA075303R1		1SDA075320R1	
			175	XT4V 250 TMA 175-1750	1SDA075304R1		1SDA075321R1	
			200	XT4V 250 TMA 200-2000	1SDA075305R1		1SDA075322R1	
			225	XT4V 250 TMA 225-2250	1SDA075306R1		1SDA075323R1	
			250	XT4V 250 TMA 250-2500	1SDA075307R1		1SDA075324R1	

SACE XT4V (150kA) Ekip LS/I Front terminals (F)

Size	lu	Trip units	In	Type	3 poles		4 poles	
					Code	Code	Code	Code
XT4	250	Ekip LS/I	40	XT4V 250 Ekip LS/I In=40A	1SDA075406R1		1SDA075412R1	
			60	XT4V 250 Ekip LS/I In=60A	1SDA075407R1		1SDA075413R1	
			100	XT4V 250 Ekip LS/I In=100A	1SDA075408R1		1SDA075414R1	
			150	XT4V 250 Ekip LS/I In=150A	1SDA075409R1		1SDA075415R1	
			225	XT4V 250 Ekip LS/I In=225A	1SDA075410R1		1SDA075416R1	
			250	XT4V 250 Ekip LS/I In=250A	1SDA075411R1		1SDA075417R1	

Ordering codes for XT4

Automatic circuit-breakers



XT4 - circuit-breaker

SACE XT4V (150kA) Ekip LSI Front terminals (F)

Size	Iu	Trip units	In	Type	3 poles	4 poles
					Code	Code
XT4	250	Ekip LSI	40	XT4V 250 Ekip LSI In=40A	1SDA075466R1	1SDA075472R1
			60	XT4V 250 Ekip LSI In=60A	1SDA075467R1	1SDA075473R1
			100	XT4V 250 Ekip LSI In=100A	1SDA075468R1	1SDA075474R1
			150	XT4V 250 Ekip LSI In=150A	1SDA075469R1	1SDA075475R1
			225	XT4V 250 Ekip LSI In=225A	1SDA075470R1	1SDA075476R1
			250	XT4V 250 Ekip LSI In=250A	1SDA075471R1	1SDA075477R1

SACE XT4V (150kA) Ekip LSI Front terminals (F)

Size	Iu	Trip units	In	Type	3 poles	4 poles
					Code	Code
XT4	250	Ekip LSI	40	XT4V 250 Ekip LSI In=40A	1SDA075526R1	1SDA075532R1
			60	XT4V 250 Ekip LSI In=60A	1SDA075527R1	1SDA075533R1
			100	XT4V 250 Ekip LSI In=100A	1SDA075528R1	1SDA075534R1
			150	XT4V 250 Ekip LSI In=150A	1SDA075529R1	1SDA075535R1
			225	XT4V 250 Ekip LSI In=225A	1SDA075530R1	1SDA075536R1
			250	XT4V 250 Ekip LSI In=250A	1SDA075531R1	1SDA075537R1

Motor protection circuit-breaker (MCP)

SACE XT4V (150kA) Ekip I Front terminals (F)

Size	Iu	Trip units	In	Type	3 poles	4 poles
					Code	Code
XT4	250	Ekip I	40	XT4V 250 Ekip I In=40A	1SDA075586R1	
			60	XT4V 250 Ekip I In=60A	1SDA075587R1	
			100	XT4V 250 Ekip I In=100A	1SDA075588R1	
			150	XT4V 250 Ekip I In=150A	1SDA075589R1	
			225	XT4V 250 Ekip I In=225A	1SDA075590R1	
			250	XT4V 250 Ekip I In=250A	1SDA075591R1	



XT4 - circuit-breaker

Motor protection circuit-breaker (MPCB)



XT4 - circuit-breaker

SACE XT4V (150kA) Ekip M-LIU Front terminals (F)

Size	Iu	Trip units	In	Type	3 poles	4 poles
					Code	Code
XT4	250	Ekip M-LIU	40	XT4V 250 Ekip M-LIU In=40A	1SDA075598R1	
			60	XT4V 250 Ekip M-LIU In=60A	1SDA075599R1	
			100	XT4V 250 Ekip M-LIU In=100A	1SDA075600R1	
			150	XT4V 250 Ekip M-LIU In=150A	1SDA075601R1	

SACE XT4V (150kA) Ekip M Touch LRIU Front terminals (F)

Size	Iu	Trip units	In	Type	3 poles	4 poles
					Code	Code
XT4	250	Ekip M Touch LRIU	100	XT4V 250 EkipMTouchLRIU 100	1SDA102295R1	
			150	XT4V 250 EkipMTouchLRIU 150	1SDA102296R1	
			200	XT4V 250 EkipMTouchLRIU 200	1SDA102297R1	

Ordering codes for XT4

Automatic circuit-breakers



XT4 - circuit-breaker

Distribution circuit-breakers

SACE XT4X (200kA) TMF/TMA Front terminals (F)

Size	lu	Trip units	In	Type	3 poles	4 poles
					Code	Code
XT4	250	TMF	25	XT4X 250 TMF 25-400		Only available with the Breaking Part + Trip unit solution
			30	XT4X 250 TMF 30-400		
			35	XT4X 250 TMF 35-400		
			40	XT4X 250 TMF 40-400		
			50	XT4X 250 TMF 50-500		
			60	XT4X 250 TMF 60-600		
			70	XT4X 250 TMF 70-700		
			80	XT4X 250 TMF 80-800		
			90	XT4X 250 TMF 90-900		
			100	XT4X 250 TMF 100-1000		
			110	XT4X 250 TMF 110-1100		
			125	XT4X 250 TMF 125-1250		
			150	XT4X 250 TMF 150-1500		
			175	XT4X 250 TMF 175-1750		
200	XT4X 250 TMF 200-2000					
225	XT4X 250 TMF 225-2250					
250	XT4X 250 TMF 250-2500					
XT4	250	TMA	80	XT4X 250 TMA 80-800		Only available with the Breaking Part + Trip unit solution
			90	XT4X 250 TMA 90-900		
			100	XT4X 250 TMA 100-1000		
			110	XT4X 250 TMA 110-1100		
			125	XT4X 250 TMA 125-1250		
			150	XT4X 250 TMA 150-1500		
			175	XT4X 250 TMA 175-1750		
			200	XT4X 250 TMA 200-2000		
			225	XT4X 250 TMA 225-2250		
			250	XT4X 250 TMA 250-2500		

SACE XT4X (200kA) Ekip LS/I Front terminals (F)

Size	lu	Trip units	In	Type	3 poles	4 poles
					Code	Code
XT4	250	Ekip LS/I	40	XT4X 250 Ekip LS/I In=40A		Only available with the Breaking Part + Trip unit solution
			60	XT4X 250 Ekip LS/I In=60A		
			100	XT4X 250 Ekip LS/I In=100A		
			150	XT4X 250 Ekip LS/I In=150A		
			225	XT4X 250 Ekip LS/I In=225A		
			250	XT4X 250 Ekip LS/I In=250A		



—
XT4 - circuit-breaker

SACE XT4X (200kA) Ekip LSI Front terminals (F)

Size	Iu	Trip units	In	Type	3 poles	4 poles
					Code	Code
XT4	250	Ekip LSI	40	XT4X 250 Ekip LSI In=40A	Only available with the Breaking Part + Trip unit solution	
			60	XT4X 250 Ekip LSI In=60A		
			100	XT4X 250 Ekip LSI In=100A		
			150	XT4X 250 Ekip LSI In=150A		
			225	XT4X 250 Ekip LSI In=225A		
			250	XT4X 250 Ekip LSI In=250A		

SACE XT4X (200kA) Ekip LSIG Front terminals (F)

Size	Iu	Trip units	In	Type	3 poles	4 poles
					Code	Code
XT4	250	Ekip LSIG	40	XT4X 250 Ekip LSIG In=40A	Only available with the Breaking Part + Trip unit solution	
			60	XT4X 250 Ekip LSIG In=60A		
			100	XT4X 250 Ekip LSIG In=100A		
			150	XT4X 250 Ekip LSIG In=150A		
			225	XT4X 250 Ekip LSIG In=225A		
			250	XT4X 250 Ekip LSIG In=250A		

Motor protection circuit-breaker (MCP)

SACE XT4X (200kA) Ekip I Front terminals (F)

Size	Iu	Trip units	In	Type	3 poles	4 poles
					Code	Code
XT4	250	Ekip I	40	XT4X 250 Ekip I In=40A	1SDA107381R1	
			60	XT4X 250 Ekip I In=60A	1SDA107382R1	
			100	XT4X 250 Ekip I In=100A	1SDA107383R1	
			150	XT4X 250 Ekip I In=150A	1SDA107384R1	
			225	XT4X 250 Ekip I In=225A	1SDA107385R1	
			250	XT4X 250 Ekip I In=250A	1SDA107386R1	



—
XT4 - circuit-breaker

Ordering codes for XT4

Automatic circuit-breakers



—
XT4 - circuit-breaker

Motor protection circuit-breaker (MPCB)

SACE XT4X (200kA) Ekip M-LIU Front terminals (F)

Size	Iu	Trip units	In	Type	3 poles	4 poles
					Code	Code
XT4	250	Ekip M-LIU	40	XT4X 250 Ekip M-LIU In=40A	1SDA107387R1	
			60	XT4X 250 Ekip M-LIU In=60A	1SDA107388R1	
			100	XT4X 250 Ekip M-LIU In=100A	1SDA107389R1	
			150	XT4X 250 Ekip M-LIU In=150A	1SDA107390R1	

SACE XT4X (200kA) Ekip M Touch LRIU Front terminals (F)

Size	Iu	Trip units	In	Type	3 poles	4 poles
					Code	Code
XT4	250	Ekip M Touch LRIU	100	XT4X 250 EkipMTouchLRIU 100	1SDA102298R1	
			150	XT4X 250 EkipMTouchLRIU 150	1SDA102299R1	
			200	XT4X 250 EkipMTouchLRIU 200	1SDA102300R1	

Molded case switches

SACE XT4D - MCS

Size	Iu	Type	3 poles	4 poles
			Code	Code
XT4	150	XT4N-D 150	1SDA083041R1	1SDA083042R1
		XT4S-D 150	1SDA083043R1	1SDA083044R1
		XT4H-D 150	1SDA083045R1	1SDA083046R1
		XT4L-D 150	1SDA083047R1	1SDA083048R1
		XT4V-D 150	1SDA083049R1	1SDA083050R1
	250	XT4N-D 250	1SDA075620R1	1SDA075621R1
		XT4S-D 250	1SDA075622R1	1SDA075623R1
		XT4H-D 250	1SDA075624R1	1SDA075625R1
		XT4L-D 250	1SDA075626R1	1SDA075627R1
		XT4V-D 250	1SDA075628R1	1SDA075629R1



—
XT4 - circuit-breaker

Ordering codes for XT4

Breaking part



XT4 - breaking part

SACE XT4 - Breaking part

Size	Iu	Icu (480V)	Type	3 poles	4 poles
				Code	Code
XT4	250	25	XT4N 250 BREAKING PART	1SDA075640R1	1SDA075645R1
		35	XT4S 250 BREAKING PART	1SDA075641R1	1SDA075646R1
		65	XT4H 250 BREAKING PART	1SDA075642R1	1SDA075647R1
		100	XT4L 250 BREAKING PART	1SDA075643R1	1SDA075648R1
		150	XT4V 250 BREAKING PART	1SDA075644R1	1SDA075649R1
		200	XT4X 250 BREAKING PART	1SDA102347R1	1SDA102349R1

100% rated distribution circuit-breakers

100% rated version extra code

Size	3 poles	4 poles
	Code	Code
XT4	1SDA076606R1	1SDA080701R1

Note: to be specified only in addition to the code of the automatic circuit-breaker or of the breaking part

Ordering codes for XT4

Trip units

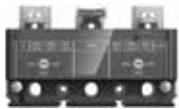

Thermal magnetic trip unit

Trip units - distribution protection

Size	Type	3 poles	4 poles
		Code	Code
XT4	TMF 25-400	1SDA075698R1	1SDA075715R1
	TMF 30-400	1SDA075699R1	1SDA075716R1
	TMF 35-400	1SDA075700R1	1SDA075717R1
	TMF 40-400	1SDA075701R1	1SDA075718R1
	TMF 50-500	1SDA075702R1	1SDA075719R1
	TMF 60-600	1SDA075703R1	1SDA075720R1
	TMF 70-700	1SDA075704R1	1SDA075721R1
	TMF 80-800	1SDA080301R1	
	TMF 90-900	1SDA080302R1	
	TMF 100-1000	1SDA080293R1	
	TMF 110-1100	1SDA080294R1	
	TMF 125-1250	1SDA080295R1	
	TMF 150-1500	1SDA080296R1	
	TMF 175-1750	1SDA080297R1	
	TMF 200-2000	1SDA080298R1	
	TMF 225-2250	1SDA080299R1	
	TMF 250-2500	1SDA080300R1	
	TMA 80-800	1SDA075705R1	1SDA075722R1
	TMA 90-900	1SDA075706R1	1SDA075723R1
	TMA 100-1000	1SDA075707R1	1SDA075724R1
	TMA 110-1100	1SDA075708R1	1SDA075725R1
	TMA 125-1250	1SDA075709R1	1SDA075726R1
	TMA 150-1500	1SDA075710R1	1SDA075727R1
	TMA 175-1750	1SDA075711R1	1SDA075728R1
	TMA 200-2000	1SDA075712R1	1SDA075729R1
	TMA 225-2250	1SDA075713R1	1SDA075730R1
	TMA 250-2500	1SDA075714R1	1SDA075731R1
	Ekip LS/I In=40A	1SDA075743R1	1SDA075749R1
	Ekip LS/I In=60A	1SDA075744R1	1SDA075750R1
	Ekip LS/I In=100A	1SDA075745R1	1SDA075751R1
	Ekip LS/I In=150A	1SDA075746R1	1SDA075752R1
	Ekip LS/I In=225A	1SDA075747R1	1SDA075753R1
	Ekip LS/I In=250A	1SDA075748R1	1SDA075754R1
	Ekip LSI In=40A	1SDA075755R1	1SDA075761R1
	Ekip LSI In=60A	1SDA075756R1	1SDA075762R1
	Ekip LSI In=100A	1SDA075757R1	1SDA075763R1
	Ekip LSI In=150A	1SDA075758R1	1SDA075764R1
	Ekip LSI In=225A	1SDA075759R1	1SDA075765R1
	Ekip LSI In=250A	1SDA075760R1	1SDA075766R1
	Ekip LSIG In=40A	1SDA075767R1	1SDA075773R1
	Ekip LSIG In=60A	1SDA075768R1	1SDA075774R1
	Ekip LSIG In=100A	1SDA075769R1	1SDA075775R1
	Ekip LSIG In=150A	1SDA075770R1	1SDA075776R1
	Ekip LSIG In=225A	1SDA075771R1	1SDA075777R1
	Ekip LSIG In=250A	1SDA075772R1	1SDA075778R1

Trip units - distribution protection

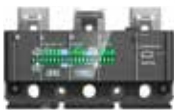

Dip trip unit



Touch trip unit

Size	Type	3 poles	4 poles
		Code	Code
XT4	Ekip Dip LIG In=40A	1SDA102389R1	1SDA102434R1
	Ekip Dip LIG In=60A	1SDA102390R1	1SDA102435R1
	Ekip Dip LIG In=100A	1SDA102391R1	1SDA102436R1
	Ekip Dip LIG In=150A	1SDA102392R1	1SDA102437R1
	Ekip Dip LIG In=225A	1SDA102393R1	1SDA102438R1
	Ekip Dip LIG In=250A	1SDA102394R1	1SDA102439R1
	Ekip Touch LSI In=100A	1SDA102364R1	1SDA102412R1
	Ekip Touch LSI In=150A	1SDA102362R1	1SDA102410R1
	Ekip Touch LSI In=225A	1SDA102363R1	1SDA102411R1
	Ekip Touch LSI In=250A	1SDA102365R1	1SDA102413R1
	Ekip Touch LSI In=100A	1SDA102368R1	1SDA102416R1
	Ekip Touch LSI In=150A	1SDA102366R1	1SDA102414R1
	Ekip Touch LSI In=225A	1SDA102367R1	1SDA102415R1
	Ekip Touch LSI In=250A	1SDA102369R1	1SDA102417R1
	Ekip Touch Measuring LSI In=100	1SDA102372R1	1SDA102420R1
	Ekip Touch Measuring LSI In=150	1SDA102370R1	1SDA102418R1
	Ekip Touch Measuring LSI In=225	1SDA102371R1	1SDA102419R1
	Ekip Touch Measuring LSI In=250	1SDA102373R1	1SDA102421R1
	Ekip Touch Measuring LSI In=100	1SDA102376R1	1SDA102424R1
	Ekip Touch Measuring LSI In=150	1SDA102374R1	1SDA102422R1
	Ekip Touch Measuring LSI In=225	1SDA102375R1	1SDA102423R1
	Ekip Touch Measuring LSI In=250	1SDA102377R1	1SDA102425R1
	Ekip Hi-Touch LSI In=100	1SDA102380R1	1SDA102428R1
	Ekip Hi-Touch LSI In=150	1SDA102378R1	1SDA102426R1
	Ekip Hi-Touch LSI In=225	1SDA102379R1	1SDA102427R1
	Ekip Hi-Touch LSI In=250	1SDA102381R1	1SDA102429R1
	Ekip Hi-Touch LSI In=100	1SDA102384R1	1SDA102432R1
	Ekip Hi-Touch LSI In=150	1SDA102382R1	1SDA102430R1
	Ekip Hi-Touch LSI In=225	1SDA102383R1	1SDA102431R1
	Ekip Hi-Touch LSI In=250	1SDA102385R1	1SDA102433R1

Ordering codes for XT4

Breaking part + trip unit solution



XT4 Breaking part



Thermal-Magnetic Trip unit



Ekip Dip Trip Unit



Thermal-Magnetic Trip unit

Breaking Part	Icu Poles	N (25kA)	S (35kA)	H (65kA)	L (100kA)	V (150kA)	X (200kA)
		3	1SDA075640R1	1SDA075641R1	1SDA075642R1	1SDA075643R1	1SDA075644R1
4	1SDA075645R1	1SDA075646R1	1SDA075647R1	1SDA075648R1	1SDA075649R1	1SDA102349R1	

Trip units	In Poles	25	30	35	40	50	60	70	80
		TMF	3	1SDA075698R1	1SDA075699R1	1SDA075700R1	1SDA075701R1	1SDA075702R1	1SDA075703R1
	4	1SDA075715R1	1SDA075716R1	1SDA075717R1	1SDA075718R1	1SDA075719R1	1SDA075720R1	1SDA075721R1	
TMA	3								1SDA075705R1
	4								1SDA075722R1
Ekip LS/I	3				1SDA075743R1		1SDA075744R1		
	4				1SDA075749R1		1SDA075750R1		
Ekip LSI	3				1SDA075755R1		1SDA075756R1		
	4				1SDA075761R1		1SDA075762R1		
Ekip LSIG	3				1SDA075767R1		1SDA075768R1		
	4				1SDA075773R1		1SDA075774R1		
Ekip Dip LIG	3				1SDA102389R1		1SDA102390R1		
	4				1SDA102434R1		1SDA102435R1		
Ekip Touch LSI	3								
	4								
Ekip Touch LSIG	3								
	4								
Ekip Touch Measuring LSI	3								
	4								
Ekip Touch Measuring LSIG	3								
	4								
Ekip Hi-Touch LSI	3								
	4								
Ekip Hi-Touch LSIG	3								
	4								

Note: When a single code for the complete circuit-breaker is not available, please configure the breaking part code with the trip unit code to order a factory-assembled circuit-breaker

90	100	110	125	150	175	200	225	250
1SDA080302R1	1SDA080293R1	1SDA080294R1	1SDA080295R1	1SDA080296R1	1SDA080297R1	1SDA080298R1	1SDA080299R1	1SDA080300R1
1SDA075706R1	1SDA075707R1	1SDA075708R1	1SDA075709R1	1SDA075710R1	1SDA075711R1	1SDA075712R1	1SDA075713R1	1SDA075714R1
1SDA075723R1	1SDA075724R1	1SDA075725R1	1SDA075726R1	1SDA075727R1	1SDA075728R1	1SDA075729R1	1SDA075730R1	1SDA075731R1
	1SDA075745R1			1SDA075746R1			1SDA075747R1	1SDA075748R1
	1SDA075751R1			1SDA075752R1			1SDA075753R1	1SDA075754R1
	1SDA075757R1			1SDA075758R1			1SDA075759R1	1SDA075760R1
	1SDA075763R1			1SDA075764R1			1SDA075765R1	1SDA075766R1
	1SDA075769R1			1SDA075770R1			1SDA075771R1	1SDA075772R1
	1SDA075775R1			1SDA075776R1			1SDA075777R1	1SDA075778R1
	1SDA102391R1			1SDA102392R1			1SDA102393R1	1SDA102394R1
	1SDA102436R1			1SDA102437R1			1SDA102438R1	1SDA102439R1
	1SDA102364R1			1SDA102362R1			1SDA102363R1	1SDA102365R1
	1SDA102412R1			1SDA102410R1			1SDA102411R1	1SDA102413R1
	1SDA102368R1			1SDA102366R1			1SDA102367R1	1SDA102369R1
	1SDA102416R1			1SDA102414R1			1SDA102415R1	1SDA102417R1
	1SDA102372R1			1SDA102370R1			1SDA102371R1	1SDA102373R1
	1SDA102420R1			1SDA102418R1			1SDA102419R1	1SDA102421R1
	1SDA102376R1			1SDA102374R1			1SDA102375R1	1SDA102377R1
	1SDA102424R1			1SDA102422R1			1SDA102423R1	1SDA102425R1
	1SDA102380R1			1SDA102378R1			1SDA102379R1	1SDA102381R1
	1SDA102428R1			1SDA102426R1			1SDA102427R1	1SDA102429R1
	1SDA102384R1			1SDA102382R1			1SDA102383R1	1SDA102385R1
	1SDA102432R1			1SDA102430R1			1SDA102431R1	1SDA102433R1

Ordering codes for XT5

Automatic circuit-breakers



XT5 - circuit-breaker

Distribution circuit-breakers

SACE XT5N (25kA) TMA- Front terminals (F)

Size	lu	Trip units	In	Type	3 poles	4 poles
					Code	Code
XT5	400	TMA	300	XT5N 400 TMA 300-3000	1SDA102443R1	1SDA102587R1
			400	XT5N 400 TMA 400-4000	1SDA102444R1	1SDA102588R1
XT5	600	TMA	500	XT5N 600 TMA 500-5000	1SDA102445R1	1SDA102589R1
			600	XT5N 600 TMA 600-6000	1SDA102446R1	1SDA102590R1

SACE XT5N (25kA) Ekip Dip LS/I - Front terminals (F)

Size	lu	Trip units	In	Type	3 poles	4 poles
					Code	Code
XT5	400	Ekip Dip LS/I	250	XT5N 400 Ekip Dip LS/I In=250A	1SDA102447R1	1SDA102591R1
			300	XT5N 400 Ekip Dip LS/I In=300A	1SDA102448R1	1SDA102592R1
			400	XT5N 400 Ekip Dip LS/I In=400A	1SDA102449R1	1SDA102593R1
XT5	600	Ekip Dip LS/I	600	XT5N 600 Ekip Dip LS/I In=600A	1SDA102450R1	1SDA102594R1

SACE XT5N (25kA) Ekip Dip LSI - Front terminals (F)

Size	lu	Trip units	In	Type	3 poles	4 poles
					Code	Code
XT5	400	Ekip Dip LSI	250	XT5N 400 Ekip Dip LSI In=250A	1SDA102451R1	1SDA102595R1
			300	XT5N 400 Ekip Dip LSI In=300A	1SDA102452R1	1SDA102596R1
			400	XT5N 400 Ekip Dip LSI In=400A	1SDA102453R1	1SDA102597R1
XT5	600	Ekip Dip LSI	600	XT5N 600 Ekip Dip LSI In=600A	1SDA102454R1	1SDA102598R1

SACE XT5N (25kA) Ekip Dip LSIG - Front terminals (F)

Size	lu	Trip units	In	Type	3 poles	4 poles
					Code	Code
XT5	400	Ekip Dip LSIG	250	XT5N 400 Ekip Dip LSIG In=250A	1SDA102455R1	1SDA102599R1
			300	XT5N 400 Ekip Dip LSIG In=300A	1SDA102456R1	1SDA102600R1
			400	XT5N 400 Ekip Dip LSIG In=400A	1SDA102457R1	1SDA102601R1
XT5	600	Ekip Dip LSIG	600	XT5N 600 Ekip Dip LSIG In=600A	1SDA102458R1	1SDA102602R1

SACE XT5N (25kA) Ekip Dip LIG - Front terminals (F)

Size	lu	Trip units	In	Type	3 poles	4 poles
					Code	Code
XT5	400	Ekip Dip LIG	250	XT5N 400 Ekip Dip LIG In=250A	1SDA102477R1	1SDA102607R1
			300	XT5N 400 Ekip Dip LIG In=300A	1SDA102478R1	1SDA102608R1
			400	XT5N 400 Ekip Dip LIG In=400A	1SDA102479R1	1SDA102609R1
XT5	600	Ekip Dip LIG	600	XT5N 600 Ekip Dip LIG In=600A	1SDA102480R1	1SDA102610R1

Motor protection circuit-breaker (MCP)

SACE XT5N (25kA) MA - Front terminals (F)

Size	lu	Trip units	In	Type	3 poles
					Code
XT5 400	MA		300	XT5N 400 MA 300-3000	1SDA102459R1
			400	XT5N 400 MA 400-4000	1SDA102460R1
XT5 600	MA		500	XT5N 600 MA 500-5000	1SDA102461R1

SACE XT5N (25kA) Ekip M Dip I - Front terminals (F)

Size	lu	Trip units	In	Type	3 poles
					Code
XT5 400	Ekip M Dip I		250	XT5N 400 Ekip M Dip I In=250A	1SDA107486R1
			300	XT5N 400 Ekip M Dip I In=300A	1SDA102462R1
			400	XT5N 400 Ekip M Dip I In=400A	1SDA102463R1
XT5 600	Ekip M Dip I		500	XT5N 600 Ekip M Dip I In=500A	1SDA102464R1

Motor protection circuit-breaker (MPCP)

SACE XT5N (25kA) Ekip M Dip LIU - Front terminals (F)

Size	lu	Trip units	In	Type	3 poles
					Code
XT5 400	Ekip M Dip LIU		250	XT5N 400 Ekip M Dip LIU In=250A	1SDA102465R1
			300	XT5N 400 Ekip M Dip LIU In=300A	1SDA102466R1
			400	XT5N 400 Ekip M Dip LIU In=400A	1SDA102467R1
XT5 600	Ekip M Dip LIU		500	XT5N 600 Ekip M Dip LIU In=500A	1SDA102468R1

SACE XT5N (25kA) Ekip M Touch LRIU - Front terminals (F)

Size	lu	Trip units	In	Type	3 poles
					Code
XT5 400	Ekip M Touch LRIU		250	XT5N 400 Ekip M Touch LRIU In=250A	1SDA102469R1
			300	XT5N 400 Ekip M Touch LRIU In=300A	1SDA102470R1
			400	XT5N 400 Ekip M Touch LRIU In=400A	1SDA102471R1
XT5 600	Ekip M Touch LRIU		500	XT5N 400 Ekip M Touch LRIU In=500A	1SDA102472R1

Generator protection circuit-breaker

SACE XT5N (25kA) TMG- Front terminals (F)

Size	lu	Trip units	In	Type	3 poles	4 poles
					Code	Code
XT5 400	TMG		300	XT5N 400 TMG 300-1500	1SDA102473R1	1SDA102603R1
			400	XT5N 400 TMG 400-2000	1SDA102474R1	1SDA102604R1
XT5 600	TMG		500	XT5N 600 TMG 500-2500	1SDA102475R1	1SDA102605R1
			600	XT5N 600 TMG 600-3000	1SDA102476R1	1SDA102606R1



XT5 - circuit-breaker



XT5 - circuit-breaker



XT5 - circuit-breaker

Ordering codes for XT5

Automatic circuit-breakers



XT5 - circuit-breaker

Distribution circuit-breakers

SACE XT5S (35kA) TMA- Front terminals (F)

Size	lu	Trip units	In	Type	3 poles	4 poles
					Code	Code
XT5	400	TMA	300	XT5S 400 TMA 300-3000	1SDA102481R1	1SDA102611R1
			400	XT5S 400 TMA 400-4000	1SDA102482R1	1SDA102612R1
XT5	600	TMA	500	XT5S 600 TMA 500-5000	1SDA102483R1	1SDA102613R1
			600	XT5S 600 TMA 600-6000	1SDA102484R1	1SDA102614R1

SACE XT5S (35kA) Ekip Dip LS/I - Front terminals (F)

Size	lu	Trip units	In	Type	3 poles	4 poles
					Code	Code
XT5	400	Ekip Dip LS/I	250	XT5S 400 Ekip Dip LS/I In=250A	1SDA102485R1	1SDA102615R1
			300	XT5S 400 Ekip Dip LS/I In=300A	1SDA102486R1	1SDA102616R1
			400	XT5S 400 Ekip Dip LS/I In=400A	1SDA102487R1	1SDA102617R1
XT5	600	Ekip Dip LS/I	600	XT5S 600 Ekip Dip LS/I In=600A	1SDA102488R1	1SDA102618R1

SACE XT5S (35kA) Ekip Dip LSI - Front terminals (F)

Size	lu	Trip units	In	Type	3 poles	4 poles
					Code	Code
XT5	400	Ekip Dip LSI	250	XT5S 400 Ekip Dip LSI In=250A	1SDA102489R1	1SDA102619R1
			300	XT5S 400 Ekip Dip LSI In=300A	1SDA102490R1	1SDA102620R1
			400	XT5S 400 Ekip Dip LSI In=400A	1SDA102491R1	1SDA102621R1
XT5	600	Ekip Dip LSI	600	XT5S 600 Ekip Dip LSI In=600A	1SDA102492R1	1SDA102622R1

SACE XT5S (35kA) Ekip Dip LSIG - Front terminals (F)

Size	lu	Trip units	In	Type	3 poles	4 poles
					Code	Code
XT5	400	Ekip Dip LSIG	250	XT5S 400 Ekip Dip LSIG In=250A	1SDA102493R1	1SDA102623R1
			300	XT5S 400 Ekip Dip LSIG In=300A	1SDA102494R1	1SDA102624R1
			400	XT5S 400 Ekip Dip LSIG In=400A	1SDA102495R1	1SDA102625R1
XT5	600	Ekip Dip LSIG	600	XT5S 600 Ekip Dip LSIG In=600A	1SDA102496R1	1SDA102626R1

SACE XT5S (35kA) Ekip Dip LIG - Front terminals (F)

Size	lu	Trip units	In	Type	3 poles	4 poles
					Code	Code
XT5	400	Ekip Dip LIG	250	XT5S 400 Ekip Dip LIG In=250A	1SDA102515R1	1SDA102631R1
			300	XT5S 400 Ekip Dip LIG In=300A	1SDA102516R1	1SDA102632R1
			400	XT5S 400 Ekip Dip LIG In=400A	1SDA102517R1	1SDA102633R1
XT5	600	Ekip Dip LIG	600	XT5S 600 Ekip Dip LIG In=600A	1SDA102518R1	1SDA102634R1

Motor protection circuit-breaker (MCP)

SACE XT5S (35kA) MA - Front terminals (F)



XT5 - circuit-breaker

Size	Iu	Trip units	In	Type	3 poles Code
XT5	400	MA	300	XT5S 400 MA 300-3000	1SDA102497R1
			400	XT5S 400 MA 400-4000	1SDA102498R1
XT5	600	MA	500	XT5S 600 MA 500-5000	1SDA102499R1

SACE XT5S (35kA) Ekip M Dip I - Front terminals (F)

Size	Iu	Trip units	In	Type	3 poles Code
XT5	400	Ekip M Dip I	250	XT5S 400 Ekip M Dip I In=250A	1SDA107487R1
			300	XT5S 400 Ekip M Dip I In=300A	1SDA102500R1
			400	XT5S 400 Ekip M Dip I In=400A	1SDA102501R1
XT5	600	Ekip M Dip I	500	XT5S 600 Ekip M Dip I In=500A	1SDA102502R1

Motor protection circuit-breaker (MPCP)

SACE XT5S (35kA) Ekip M Dip LIU - Front terminals (F)



XT5 - circuit-breaker

Size	Iu	Trip units	In	Type	3 poles Code
XT5	400	Ekip M Dip LIU	250	XT5S 400 Ekip M Dip LIU In=250A	1SDA102503R1
			300	XT5S 400 Ekip M Dip LIU In=300A	1SDA102504R1
			400	XT5S 400 Ekip M Dip LIU In=400A	1SDA102505R1
XT5	600	Ekip M Dip LIU	500	XT5S 600 Ekip M Dip LIU In=500A	1SDA102506R1

SACE XT5S (35kA) Ekip M Touch LRIU - Front terminals (F)

Size	Iu	Trip units	In	Type	3 poles Code
XT5	400	Ekip M Touch LRIU	250	XT5S 400 Ekip M Touch LRIU In=250A	1SDA102507R1
			300	XT5S 400 Ekip M Touch LRIU In=300A	1SDA102508R1
			400	XT5S 400 Ekip M Touch LRIU In=400A	1SDA102509R1
XT5	600	Ekip M Touch LRIU	500	XT5S 600 Ekip M Touch LRIU In=500A	1SDA102510R1

Generator protection circuit-breaker

SACE XT5S (35kA) TMG- Front terminals (F)



XT5 - circuit-breaker

Size	Iu	Trip units	In	Type	3 poles Code	4 poles Code
XT5	400	TMG	300	XT5S 400 TMG 300-1500	1SDA102549R1	1SDA102651R1
			400	XT5S 400 TMG 400-2000	1SDA102550R1	1SDA102652R1
XT5	600	TMG	500	XT5S 600 TMG 500-2500	1SDA102513R1	1SDA102629R1
			600	XT5S 600 TMG 600-3000	1SDA102552R1	1SDA102654R1

Ordering codes for XT5

Automatic circuit-breakers



XT5 - circuit-breaker

Distribution circuit-breakers

SACE XT5H (65kA) TMA- Front terminals (F)

Size	Iu	Trip units	In	Type	3 poles	4 poles
					Code	Code
XT5	400	TMA	300	XT5H 400 TMA 300-3000	1SDA102519R1	1SDA102635R1
			400	XT5H 400 TMA 400-4000	1SDA102520R1	1SDA102636R1
XT5	600	TMA	500	XT5H 600 TMA 500-5000	1SDA102521R1	1SDA102637R1
			600	XT5H 600 TMA 600-6000	1SDA102522R1	1SDA102638R1

SACE XT5H (65kA) Ekip Dip LS/I - Front terminals (F)

Size	Iu	Trip units	In	Type	3 poles	4 poles
					Code	Code
XT5	400	Ekip Dip LS/I	250	XT5H 400 Ekip Dip LS/I In=250A	1SDA102523R1	1SDA102639R1
			300	XT5H 400 Ekip Dip LS/I In=300A	1SDA102524R1	1SDA102640R1
			400	XT5H 400 Ekip Dip LS/I In=400A	1SDA102525R1	1SDA102641R1
XT5	600	Ekip Dip LS/I	600	XT5H 600 Ekip Dip LS/I In=600A	1SDA102526R1	1SDA102642R1

SACE XT5H (65kA) Ekip Dip LSI - Front terminals (F)

Size	Iu	Trip units	In	Type	3 poles	4 poles
					Code	Code
XT5	400	Ekip Dip LSI	250	XT5H 400 Ekip Dip LSI In=250A	1SDA102527R1	1SDA102643R1
			300	XT5H 400 Ekip Dip LSI In=300A	1SDA102528R1	1SDA102644R1
			400	XT5H 400 Ekip Dip LSI In=400A	1SDA102529R1	1SDA102645R1
XT5	600	Ekip Dip LSI	600	XT5H 600 Ekip Dip LSI In=600A	1SDA102530R1	1SDA102646R1

SACE XT5H (65kA) Ekip Dip LSIG - Front terminals (F)

Size	Iu	Trip units	In	Type	3 poles	4 poles
					Code	Code
XT5	400	Ekip Dip LSIG	250	XT5H 400 Ekip Dip LSIG In=250A	1SDA102531R1	1SDA102647R1
			300	XT5H 400 Ekip Dip LSIG In=300A	1SDA102532R1	1SDA102648R1
			400	XT5H 400 Ekip Dip LSIG In=400A	1SDA102533R1	1SDA102649R1
XT5	600	Ekip Dip LSIG	600	XT5H 600 Ekip Dip LSIG In=600A	1SDA102534R1	1SDA102650R1

SACE XT5H (65kA) Ekip Dip LIG - Front terminals (F)

Size	Iu	Trip units	In	Type	3 poles	4 poles
					Code	Code
XT5	400	Ekip Dip LIG	250	XT5H 400 Ekip Dip LIG In=250A	1SDA102553R1	1SDA102655R1
			300	XT5H 400 Ekip Dip LIG In=300A	1SDA102554R1	1SDA102656R1
			400	XT5H 400 Ekip Dip LIG In=400A	1SDA102555R1	1SDA102657R1
XT5	600	Ekip Dip LIG	600	XT5H 600 Ekip Dip LIG In=600A	1SDA102556R1	1SDA102658R1

Motor protection circuit-breaker (MCP)

SACE XT5H (65kA) MA - Front terminals (F)

Size	lu	Trip units	In	Type	3 poles
					Code
XT5 400	MA		300	XT5H 400 MA 300-3000	1SDA102535R1
			400	XT5H 400 MA 400-4000	1SDA102536R1
XT5 600	MA		500	XT5H 600 MA 500-5000	1SDA102537R1

SACE XT5H (65kA) Ekip M Dip I - Front terminals (F)

Size	lu	Trip units	In	Type	3 poles
					Code
XT5 400	Ekip M Dip I		250	XT5H 400 Ekip M Dip I In=250A	1SDA107488R1
			300	XT5H 400 Ekip M Dip I In=300A	1SDA102538R1
			400	XT5H 400 Ekip M Dip I In=400A	1SDA102539R1
XT5 600	Ekip M Dip I		500	XT5H 600 Ekip M Dip I In=500A	1SDA102540R1

Motor protection circuit-breaker (MPCP)

SACE XT5H (65kA) Ekip M Dip LIU - Front terminals (F)

Size	lu	Trip units	In	Type	3 poles
					Code
XT5 400	Ekip M Dip LIU		250	XT5H 400 Ekip M Dip LIU In=250A	1SDA102541R1
			300	XT5H 400 Ekip M Dip LIU In=300A	1SDA102542R1
			400	XT5H 400 Ekip M Dip LIU In=400A	1SDA102543R1
XT5 600	Ekip M Dip LIU		500	XT5H 600 Ekip M Dip LIU In=500A	1SDA102544R1

SACE XT5H (65kA) Ekip M Touch LRIU - Front terminals (F)

Size	lu	Trip units	In	Type	3 poles
					Code
XT5 400	Ekip M Touch LRIU		250	XT5H 400 Ekip M Touch LRIU In=250A	1SDA102545R1
			300	XT5H 400 Ekip M Touch LRIU In=300A	1SDA102546R1
			400	XT5H 400 Ekip M Touch LRIU In=400A	1SDA102547R1
XT5 600	Ekip M Touch LRIU		500	XT5H 600 Ekip M Touch LRIU In=500A	1SDA102548R1

Generator protection circuit-breaker

SACE XT5H (65kA) TMG- Front terminals (F)

Size	lu	Trip units	In	Type	3 poles	4 poles
					Code	Code
XT5 400	TMG		300	XT5H 400 TMG 300-1500	1SDA102549R1	1SDA102651R1
			400	XT5H 400 TMG 400-2000	1SDA102550R1	1SDA102652R1
XT5 600	TMG		500	XT5H 600 TMG 500-2500	1SDA102551R1	1SDA102653R1
			600	XT5H 600 TMG 600-3000	1SDA102552R1	1SDA102654R1



XT5 - circuit-breaker



XT5 - circuit-breaker



XT5 - circuit-breaker

Ordering codes for XT5

Automatic circuit-breakers



XT5 - circuit-breaker

Distribution circuit-breakers

SACE XT5L (100kA) TMA- Front terminals (F)

Size	Iu	Trip units	In	Type	3 poles	4 poles
					Code	Code
XT5	400	TMA	300	XT5L 400 TMA 300-3000	Only available with the Breaking Part + Trip unit solution	
			400	XT5L 400 TMA 400-4000		
XT5	600	TMA	600	XT5L 600 TMA 600-6000		

SACE XT5L (100kA) Ekip Dip LS/I - Front terminals (F)

Size	Iu	Trip units	In	Type	3 poles	4 poles
					Code	Code
XT5	400	Ekip Dip LS/I	250	XT5L 400 Ekip Dip LS/I In=250A	Only available with the Breaking Part + Trip unit solution	
			300	XT5L 400 Ekip Dip LS/I In=300A		
			400	XT5L 400 Ekip Dip LS/I In=400A		
XT5	600	Ekip Dip LS/I	600	XT5L 600 Ekip Dip LS/I In=600A		

SACE XT5L (100kA) Ekip Dip LSI - Front terminals (F)

Size	Iu	Trip units	In	Type	3 poles	4 poles
					Code	Code
XT5	400	Ekip Dip LSI	250	XT5L 400 Ekip Dip LSI In=250A	Only available with the Breaking Part + Trip unit solution	
			300	XT5L 400 Ekip Dip LSI In=300A		
			400	XT5L 400 Ekip Dip LSI In=400A		
XT5	600	Ekip Dip LSI	600	XT5L 600 Ekip Dip LSI In=600A		

SACE XT5L (100kA) Ekip Dip LSIG - Front terminals (F)

Size	Iu	Trip units	In	Type	3 poles	4 poles
					Code	Code
XT5	400	Ekip Dip LSIG	250	XT5L 400 Ekip Dip LSIG In=250A	Only available with the Breaking Part + Trip unit solution	
			300	XT5L 400 Ekip Dip LSIG In=300A		
			400	XT5L 400 Ekip Dip LSIG In=400A		
XT5	600	Ekip Dip LSIG	600	XT5L 600 Ekip Dip LSIG In=600A		

SACE XT5L (100kA) Ekip Dip LIG - Front terminals (F)

Size	Iu	Trip units	In	Type	3 poles	4 poles
					Code	Code
XT5	400	Ekip Dip LIG	250	XT5L 400 Ekip Dip LIG In=250A	Only available with the Breaking Part + Trip unit solution	
			300	XT5L 400 Ekip Dip LIG In=300A		
			400	XT5L 400 Ekip Dip LIG In=400A		
XT5	600	Ekip Dip LIG	600	XT5L 600 Ekip Dip LIG In=600A		



XT5 - circuit-breaker

Motor protection circuit-breaker (MCP)

SACE XT5L (100kA) MA - Front terminals (F)

Size	Iu	Trip units	In	Type	3 poles Code
XT5 400	MA		300	XT5L 400 MA 300-3000	1SDA102557R1
			400	XT5L 400 MA 400-4000	1SDA102558R1
XT5 600	MA		500	XT5L 600 MA 500-5000	1SDA102559R1

SACE XT5L (100kA) Ekip M Dip I - Front terminals (F)

Size	Iu	Trip units	In	Type	3 poles Code
XT5 400	Ekip M Dip I		250	XT5L 400 Ekip M Dip I In=250A	1SDA107489R1
			300	XT5L 400 Ekip M Dip I In=300A	1SDA102560R1
			400	XT5L 400 Ekip M Dip I In=400A	1SDA102561R1
XT5 600	Ekip M Dip I		500	XT5L 600 Ekip M Dip I In=500A	1SDA102562R1

Motor protection circuit-breaker (MPCP)

SACE XT5L (100kA) Ekip M Dip LIU - Front terminals (F)

Size	Iu	Trip units	In	Type	3 poles Code
XT5 400	Ekip M Dip LIU		250	XT5L 400 Ekip M Dip LIU In=250A	1SDA107368R1
			300	XT5L 400 Ekip M Dip LIU In=300A	1SDA107369R1
			400	XT5L 400 Ekip M Dip LIU In=400A	1SDA107371R1
XT5 600	Ekip M Dip LIU		500	XT5L 600 Ekip M Dip LIU In=500A	1SDA107372R1



XT5 - circuit-breaker

SACE XT5L (100kA) Ekip M Touch LRIU - Front terminals (F)

Size	Iu	Trip units	In	Type	3 poles Code
XT5 400	Ekip M Touch LRIU		250	XT5L 400 Ekip M Touch LRIU In=250A	1SDA102563R1
			300	XT5L 400 Ekip M Touch LRIU In=300A	1SDA102564R1
			400	XT5L 400 Ekip M Touch LRIU In=400A	1SDA102565R1
XT5 600	Ekip M Touch LRIU		500	XT5L 600 Ekip M Touch LRIU In=500A	1SDA102566R1

Generator protection circuit-breaker

SACE XT5L (100kA) TMG- Front terminals (F)

Size	Iu	Trip units	In	Type	3 poles Code	4 poles Code
XT5 400	TMG		300	XT5L 400 TMG 300-1500		
			400	XT5L 400 TMG 400-2000		
XT5 600	TMG		600	XT5L 600 TMG 600-3000	Only available with the Breaking Part + Trip unit solution	



XT5 - circuit-breaker

Ordering codes for XT5

Automatic circuit-breakers



XT5 - circuit-breaker

Distribution circuit-breakers

SACE XT5V (150kA) TMA- Front terminals (F)

Size	Iu	Trip units	In	Type	3 poles	4 poles
					Code	Code
XT5	400	TMA	300	XT5V 400 TMA 300-3000	Only available with the Breaking Part + Trip unit solution	
			400	XT5V 400 TMA 400-4000		
XT5	600	TMA	600	XT5V 600 TMA 600-6000		

SACE XT5V (150kA) Ekip Dip LS/I - Front terminals (F)

Size	Iu	Trip units	In	Type	3 poles	4 poles
					Code	Code
XT5	400	Ekip Dip LS/I	250	XT5V 400 Ekip Dip LS/I In=250A	Only available with the Breaking Part + Trip unit solution	
			300	XT5V 400 Ekip Dip LS/I In=300A		
			400	XT5V 400 Ekip Dip LS/I In=400A		
XT5	600	Ekip Dip LS/I	600	XT5V 600 Ekip Dip LS/I In=600A		

SACE XT5V (150kA) Ekip Dip LSI - Front terminals (F)

Size	Iu	Trip units	In	Type	3 poles	4 poles
					Code	Code
XT5	400	Ekip Dip LSI	250	XT5V 400 Ekip Dip LSI In=250A	Only available with the Breaking Part + Trip unit solution	
			300	XT5V 400 Ekip Dip LSI In=300A		
			400	XT5V 400 Ekip Dip LSI In=400A		
XT5	600	Ekip Dip LSI	600	XT5V 600 Ekip Dip LSI In=600A		

SACE XT5V (150kA) Ekip Dip LSIG - Front terminals (F)

Size	Iu	Trip units	In	Type	3 poles	4 poles
					Code	Code
XT5	400	Ekip Dip LSIG	250	XT5V 400 Ekip Dip LSIG In=250A	Only available with the Breaking Part + Trip unit solution	
			300	XT5V 400 Ekip Dip LSIG In=300A		
			400	XT5V 400 Ekip Dip LSIG In=400A		
XT5	600	Ekip Dip LSIG	600	XT5V 600 Ekip Dip LSIG In=600A		

SACE XT5V (150kA) Ekip Dip LIG - Front terminals (F)

Size	Iu	Trip units	In	Type	3 poles	4 poles
					Code	Code
XT5	400	Ekip Dip LIG	250	XT5V 400 Ekip Dip LIG In=250A	Only available with the Breaking Part + Trip unit solution	
			300	XT5V 400 Ekip Dip LIG In=300A		
			400	XT5V 400 Ekip Dip LIG In=400A		
XT5	600	Ekip Dip LIG	600	XT5V 600 Ekip Dip LIG In=600A		



XT5 - circuit-breaker

Motor protection circuit-breaker (MCP)

SACE XT5V (150kA) MA - Front terminals (F)

Size	Iu	Trip units	In	Type	3 poles
					Code
XT5 400	MA		300	XT5V 400 MA 300-3000	1SDA102567R1
			400	XT5V 400 MA 400-4000	1SDA102568R1
XT5 600	MA		500	XT5V 600 MA 500-5000	1SDA102569R1

SACE XT5V (150kA) Ekip M Dip I - Front terminals (F)

Size	Iu	Trip units	In	Type	3 poles
					Code
XT5 400	Ekip M Dip I		250	XT5V 400 Ekip M Dip I In=250A	1SDA107490R1
			300	XT5V 400 Ekip M Dip I In=300A	1SDA102570R1
			400	XT5V 400 Ekip M Dip I In=400A	1SDA102571R1
XT5 600	Ekip M Dip I		500	XT5V 600 Ekip M Dip I In=500A	1SDA102572R1

Motor protection circuit-breaker (MPCP)

SACE XT5V (150kA) Ekip M Dip LIU - Front terminals (F)

Size	Iu	Trip units	In	Type	3 poles
					Code
XT5 400	Ekip M Dip LIU		250	XT5V 400 Ekip M Dip LIU In=250A	1SDA107373R1
			300	XT5V 400 Ekip M Dip LIU In=300A	1SDA107374R1
			400	XT5V 400 Ekip M Dip LIU In=400A	1SDA107375R1
XT5 600	Ekip M Dip LIU		500	XT5V 600 Ekip M Dip LIU In=500A	1SDA107376R1



XT5 - circuit-breaker

SACE XT5V (150kA) Ekip M Touch LRIU - Front terminals (F)

Size	Iu	Trip units	In	Type	3 poles
					Code
XT5 400	Ekip M Touch LRIU		250	XT5V 400 Ekip M Touch LRIU In=250A	1SDA102573R1
			300	XT5V 400 Ekip M Touch LRIU In=300A	1SDA102574R1
			400	XT5V 400 Ekip M Touch LRIU In=400A	1SDA102575R1
XT5 600	Ekip M Touch LRIU		500	XT5V 600 Ekip M Touch LRIU In=500A	1SDA102576R1

Generator protection circuit-breaker

SACE XT5V (150kA) TMG- Front terminals (F)

Size	Iu	Trip units	In	Type	3 poles	4 poles
					Code	Code
XT5 400	TMG		300	XT5V 400 TMG 300-1500		
			400	XT5V 400 TMG 400-2000		
XT5 600	TMG		600	XT5V 600 TMG 600-3000	Only available with the Breaking Part + Trip unit solution	



XT5 - circuit-breaker

Ordering codes for XT5

Automatic circuit-breakers



XT5 - circuit-breaker

Distribution circuit-breakers

SACE XT5X (200kA) TMA- Front terminals (F)

Size	Iu	Trip units	In	Type	3 poles	4 poles
					Code	Code
XT5	400	TMA	300	XT5X 400 TMA 300-3000	Only available with the Breaking Part + Trip unit solution	
			400	XT5X 400 TMA 400-4000		
XT5	600	TMA	600	XT5X 600 TMA 600-6000		

SACE XT5X (200kA) Ekip Dip LS/I - Front terminals (F)

Size	Iu	Trip units	In	Type	3 poles	4 poles
					Code	Code
XT5	400	Ekip Dip LS/I	250	XT5X 400 Ekip Dip LS/I In=250A	Only available with the Breaking Part + Trip unit solution	
			300	XT5X 400 Ekip Dip LS/I In=300A		
			400	XT5X 400 Ekip Dip LS/I In=400A		
XT5	600	Ekip Dip LS/I	600	XT5X 600 Ekip Dip LS/I In=600A		

SACE XT5X (200kA) Ekip Dip LSI - Front terminals (F)

Size	Iu	Trip units	In	Type	3 poles	4 poles
					Code	Code
XT5	400	Ekip Dip LSI	250	XT5X 400 Ekip Dip LSI In=250A	Only available with the Breaking Part + Trip unit solution	
			300	XT5X 400 Ekip Dip LSI In=300A		
			400	XT5X 400 Ekip Dip LSI In=400A		
XT5	600	Ekip Dip LSI	600	XT5X 600 Ekip Dip LSI In=600A		

SACE XT5X (200kA) Ekip Dip LSIG - Front terminals (F)

Size	Iu	Trip units	In	Type	3 poles	4 poles
					Code	Code
XT5	400	Ekip Dip LSIG	250	XT5X 400 Ekip Dip LSIG In=250A	Only available with the Breaking Part + Trip unit solution	
			300	XT5X 400 Ekip Dip LSIG In=300A		
			400	XT5X 400 Ekip Dip LSIG In=400A		
XT5	600	Ekip Dip LSIG	600	XT5X 600 Ekip Dip LSIG In=600A		

SACE XT5X (200kA) Ekip Dip LIG - Front terminals (F)

Size	Iu	Trip units	In	Type	3 poles	4 poles
					Code	Code
XT5	400	Ekip Dip LIG	250	XT5X 400 Ekip Dip LIG In=250A	Only available with the Breaking Part + Trip unit solution	
			300	XT5X 400 Ekip Dip LIG In=300A		
			400	XT5X 400 Ekip Dip LIG In=400A		
XT5	600	Ekip Dip LIG	600	XT5X 600 Ekip Dip LIG In=600A		

Motor protection circuit-breaker (MCP)

SACE XT5X (200kA) MA - Front terminals (F)

Size	Iu	Trip units	In	Type	3 poles
					Code
XT5 400	MA		300	XT5X 400 MA 300-3000	1SDA102577R1
			400	XT5X 400 MA 400-4000	1SDA102578R1
XT5 600	MA		500	XT5X 600 MA 500-5000	1SDA102579R1

SACE XT5X (200kA) Ekip M Dip I - Front terminals (F)

Size	Iu	Trip units	In	Type	3 poles
					Code
XT5 400	Ekip M Dip I		250	XT5X 400 Ekip M Dip I In=250A	1SDA107491R1
			300	XT5X 400 Ekip M Dip I In=300A	1SDA102580R1
			400	XT5X 400 Ekip M Dip I In=400A	1SDA102581R1
XT5 600	Ekip M Dip I		500	XT5X 600 Ekip M Dip I In=500A	1SDA102582R1



XT5 - circuit-breaker

Motor protection circuit-breaker (MPCP)

SACE XT5X (200kA) Ekip M Dip LIU - Front terminals (F)

Size	Iu	Trip units	In	Type	3 poles
					Code
XT5 400	Ekip M Dip LIU		250	XT5X 400 Ekip M Dip LIU In=250A	1SDA107377R1
			300	XT5X 400 Ekip M Dip LIU In=300A	1SDA107378R1
			400	XT5X 400 Ekip M Dip LIU In=400A	1SDA107379R1
XT5 600	Ekip M Dip LIU		500	XT5X 600 Ekip M Dip LIU In=500A	1SDA107380R1



XT5 - circuit-breaker

SACE XT5X (200kA) Ekip M Touch LRIU - Front terminals (F)

Size	Iu	Trip units	In	Type	3 poles
					Code
XT5 400	Ekip M Touch LRIU		250	XT5X 400 Ekip M Touch LRIU In=250A	1SDA102583R1
			300	XT5X 400 Ekip M Touch LRIU In=300A	1SDA102584R1
			400	XT5X 400 Ekip M Touch LRIU In=400A	1SDA102585R1
XT5 600	Ekip M Touch LRIU		500	XT5X 600 Ekip M Touch LRIU In=500A	1SDA102586R1

Generator protection circuit-breaker

SACE XT5X (200kA) TMG- Front terminals (F)

Size	Iu	Trip units	In	Type	3 poles	4 poles
					Code	Code
XT5 400	TMG		300	XT5X 400 TMG 300-1500		
			400	XT5X 400 TMG 400-2000		
XT5 600	TMG		600	XT5X 600 TMG 600-3000	Only available with the Breaking Part + Trip unit solution	



XT5 - circuit-breaker

Ordering codes for XT5

Automatic circuit-breakers



XT5 - circuit-breaker

Molded case switches

SACE XT5D - MCS

Size lu	Type	3 poles	4 poles
		Code	Code
400	XT5N-D 400	1SDA102659R1	1SDA102669R1
	XT5S-D 400	1SDA102661R1	1SDA102671R1
	XT5H-D 400	1SDA102663R1	1SDA102673R1
	XT5L-D 400	1SDA102665R1	1SDA102675R1
	XT5V-D 400	1SDA102667R1	1SDA102677R1
600	XT5N-D 600	1SDA102660R1	1SDA102670R1
	XT5S-D 600	1SDA102662R1	1SDA102672R1
	XT5H-D 600	1SDA102664R1	1SDA102674R1
	XT5L-D 600	1SDA102666R1	1SDA102676R1
	XT5V-D 600	1SDA102668R1	1SDA102678R1

Ordering codes for XT5

Breaking part



XT5 - breaking part

SACE XT5 - Breaking part

Size	Iu	Icu (480V)	Type	3 poles	4 poles
				Code	Code
XT5	400	25	XT5N 400 BREAKING PART	1SDA102679R1	1SDA102691R1
	600	25	XT5N 600 BREAKING PART	1SDA102680R1	1SDA102692R1
	400	35	XT5S 400 BREAKING PART	1SDA102681R1	1SDA102693R1
	600	35	XT5S 600 BREAKING PART	1SDA102682R1	1SDA102694R1
	400	65	XT5H 400 BREAKING PART	1SDA102683R1	1SDA102695R1
	600	65	XT5H 600 BREAKING PART	1SDA102684R1	1SDA102696R1
	400	100	XT5L 400 BREAKING PART	1SDA102685R1	1SDA102697R1
	600	100	XT5L 600 BREAKING PART	1SDA102686R1	1SDA102698R1
	400	150	XT5V 400 BREAKING PART	1SDA102687R1	1SDA102699R1
	600	150	XT5V 600 BREAKING PART	1SDA102688R1	1SDA102700R1
	400	200	XT5X 400 BREAKING PART	1SDA102689R1	1SDA102701R1
	600	200	XT5X 600 BREAKING PART	1SDA102690R1	1SDA102702R1

100% rated distribution circuit-breakers

100% rated version extra code

Size	3 poles	4 poles
	Code	Code
XT5	1SDA112973R1	1SDA112974R1

Note: to be specified only in addition to the code of the automatic circuit-breaker or of the breaking part

Ordering codes for XT5

Trip units

Trip units - distribution protection

Size	Type	3 poles	4 poles
		Code	Code
XT5	TMA 300-3000	1SDA102703R1	1SDA102780R1
	TMA 400-4000	1SDA102704R1	1SDA102781R1
	TMA 500-5000	1SDA102705R1	1SDA102782R1
	TMA 600-6000	1SDA102706R1	1SDA102783R1
	Ekip Dip LS/I In=250A	1SDA102707R1	1SDA102784R1
	Ekip Dip LS/I In=300A	1SDA102708R1	1SDA102785R1
	Ekip Dip LS/I In=400A	1SDA102709R1	1SDA102786R1
	Ekip Dip LS/I In=600A	1SDA102710R1	1SDA102787R1
	Ekip Dip LSI In=250A	1SDA102711R1	1SDA102788R1
	Ekip Dip LSI In=300A	1SDA102712R1	1SDA102789R1
	Ekip Dip LSI In=400A	1SDA102713R1	1SDA102790R1
	Ekip Dip LSI In=600A	1SDA102714R1	1SDA102791R1
	Ekip Dip LSIG In=250A	1SDA102715R1	1SDA102792R1
	Ekip Dip LSIG In=300A	1SDA102716R1	1SDA102793R1
	Ekip Dip LSIG In=400A	1SDA102717R1	1SDA102794R1
	Ekip Dip LSIG In=600A	1SDA102718R1	1SDA102795R1
	Ekip Dip LIG In=250A	1SDA102773R1	1SDA102832R1
	Ekip Dip LIG In=300A	1SDA102774R1	1SDA102833R1
	Ekip Dip LIG In=400A	1SDA102775R1	1SDA102834R1
	Ekip Dip LIG In=600A	1SDA102776R1	1SDA102835R1
	Ekip Touch LSI In=250A	1SDA102719R1	1SDA102796R1
	Ekip Touch LSI In=300A	1SDA102720R1	1SDA102797R1
	Ekip Touch LSI In=400A	1SDA102721R1	1SDA102798R1
	Ekip Touch LSI In=600A	1SDA102722R1	1SDA102799R1
	Ekip Touch LSIG In=250A	1SDA102723R1	1SDA102800R1
	Ekip Touch LSIG In=300A	1SDA102724R1	1SDA102801R1
	Ekip Touch LSIG In=400A	1SDA102725R1	1SDA102802R1
	Ekip Touch LSIG In=600A	1SDA102726R1	1SDA102803R1
	Ekip Touch Measuring LSI In=250	1SDA102727R1	1SDA102804R1
	Ekip Touch Measuring LSI In=300	1SDA102728R1	1SDA102805R1
	Ekip Touch Measuring LSI In=400	1SDA102729R1	1SDA102806R1
	Ekip Touch Measuring LSI In=600	1SDA102730R1	1SDA102807R1
	Ekip Touch Measuring LSIG In=250	1SDA102731R1	1SDA102808R1
	Ekip Touch Measuring LSIG In=300	1SDA102732R1	1SDA102809R1
	Ekip Touch Measuring LSIG In=400	1SDA102733R1	1SDA102810R1
	Ekip Touch Measuring LSIG In=600	1SDA102734R1	1SDA102811R1
Ekip Hi-Touch LSI In=250	1SDA102735R1	1SDA102812R1	
Ekip Hi-Touch LSI In=300	1SDA102736R1	1SDA102813R1	
Ekip Hi-Touch LSI In=400	1SDA102737R1	1SDA102814R1	
Ekip Hi-Touch LSI In=600	1SDA102738R1	1SDA102815R1	
Ekip Hi-Touch LSIG In=250	1SDA102739R1	1SDA102816R1	
Ekip Hi-Touch LSIG In=300	1SDA102740R1	1SDA102817R1	
Ekip Hi-Touch LSIG In=400	1SDA102741R1	1SDA102818R1	
Ekip Hi-Touch LSIG In=600	1SDA102742R1	1SDA102819R1	



Thermal magnetic trip unit

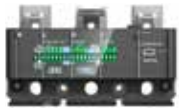

Dip trip unit



Touch trip unit

Trip units - Generator protection

Size	Type	3 poles	4 poles
		Code	Code
XT5	TMG 300-1500	1SDA102757R1	1SDA107795R1
	TMG 400-2000	1SDA102758R1	1SDA107796R1
	TMG 500-2500	1SDA102759R1	1SDAXXXXXXR1
	TMG 600-3000	1SDA102760R1	1SDA107797R1
	Ekip G Dip LS/I In=250	1SDA102761R1	1SDA102820R1
	Ekip G Dip LS/I In=300	1SDA102762R1	1SDA102821R1
	Ekip G Dip LS/I In=400	1SDA102763R1	1SDA102822R1
	Ekip G Dip LS/I In=600	1SDA102764R1	1SDA102823R1
	Ekip G Touch LSIG In=250	1SDA102765R1	1SDA102824R1
	Ekip G Touch LSIG In=300	1SDA102766R1	1SDA102825R1
	Ekip G Touch LSIG In=400	1SDA102767R1	1SDA102826R1
	Ekip G Touch LSIG In=600	1SDA102768R1	1SDA102827R1
	Ekip G Hi-Touch LSIG In=250	1SDA102769R1	1SDA102828R1
	Ekip G Hi-Touch LSIG In=300	1SDA102770R1	1SDA102829R1
	Ekip G Hi-Touch LSIG In=400	1SDA102771R1	1SDA102830R1
	Ekip G Hi-Touch LSIG In=600	1SDA102772R1	1SDA102831R1

Ordering codes for XT5

Breaking part + trip unit solution



XT5 Breaking part



Thermal-Magnetic Trip unit



Ekip Dip Trip Unit



Thermal-Magnetic Trip unit

Breaking Part	Iu	Icu Poles	N (25kA)	S (35kA)	H (65kA)	L (100kA)	V (150kA)	X (200kA)
			400	3	1SDA102679R1	1SDA102681R1	1SDA102683R1	1SDA102685R1
	4	1SDA102691R1	1SDA102693R1	1SDA102695R1	1SDA102697R1	1SDA102699R1	1SDA102701R1	
600	3	1SDA102680R1	1SDA102682R1	1SDA102684R1	1SDA102686R1	1SDA102688R1	1SDA102690R1	
	4	1SDA102692R1	1SDA102694R1	1SDA102696R1	1SDA102698R1	1SDA102700R1	1SDA102702R1	

Trip units	In Poles	250	300	400	500	600
		TMA	3		1SDA102703R1	1SDA102704R1
	4		1SDA102780R1	1SDA102781R1	1SDA102782R1	1SDA102783R1
Ekip Dip LS/I	3	1SDA102707R1	1SDA102708R1	1SDA102709R1		1SDA102710R1
	4	1SDA102784R1	1SDA102785R1	1SDA102786R1		1SDA102787R1
Ekip Dip LSI	3	1SDA102711R1	1SDA102712R1	1SDA102713R1		1SDA102714R1
	4	1SDA102788R1	1SDA102789R1	1SDA102790R1		1SDA102791R1
Ekip Dip LSIG	3	1SDA102715R1	1SDA102716R1	1SDA102717R1		1SDA102718R1
	4	1SDA102792R1	1SDA102793R1	1SDA102794R1		1SDA102795R1
Ekip Dip LIG	3	1SDA102773R1	1SDA102774R1	1SDA102775R1		1SDA102776R1
	4	1SDA102832R1	1SDA102833R1	1SDA102834R1		1SDA102835R1
Ekip Touch LS	3	1SDA102719R1	1SDA102720R1	1SDA102721R1		1SDA102722R1
	4	1SDA102796R1	1SDA102797R1	1SDA102798R1		1SDA102799R1
Ekip Touch LSIG	3	1SDA102723R1	1SDA102724R1	1SDA102725R1		1SDA102726R1
	4	1SDA102800R1	1SDA102801R1	1SDA102802R1		1SDA102803R1
Ekip Touch Measuring LSI	3	1SDA102727R1	1SDA102728R1	1SDA102729R1		1SDA102730R1
	4	1SDA102804R1	1SDA102805R1	1SDA102806R1		1SDA102807R1
Ekip Touch Measuring LSIG	3	1SDA102731R1	1SDA102732R1	1SDA102733R1		1SDA102734R1
	4	1SDA102808R1	1SDA102809R1	1SDA102810R1		1SDA102811R1
Ekip Hi-Touch LSI	3	1SDA102735R1	1SDA102736R1	1SDA102737R1		1SDA102738R1
	4	1SDA102812R1	1SDA102813R1	1SDA102814R1		1SDA102815R1
Ekip Hi-Touch LSIG	4	1SDA102739R1	1SDA102740R1	1SDA102741R1		1SDA102742R1
		1SDA102816R1	1SDA102817R1	1SDA102818R1		1SDA102819R1
TMG	3		1SDA102757R1	1SDA102758R1	1SDA102759R1	1SDA102760R1
	4		1SDA107795R1	1SDA107796R1	1SDAXXXXXXR1	1SDA107797R1
Ekip G Dip LS/I	3	1SDA102761R1	1SDA102762R1	1SDA102763R1		1SDA102764R1
	4	1SDA102820R1	1SDA102821R1	1SDA102822R1		1SDA102823R1
Ekip G Touch LSIG	3	1SDA102765R1	1SDA102766R1	1SDA102767R1		1SDA102768R1
	4	1SDA102824R1	1SDA102825R1	1SDA102826R1		1SDA102827R1
Ekip G Hi-Touch LSI	3	1SDA102769R1	1SDA102770R1	1SDA102771R1		1SDA102772R1
	4	1SDA102828R1	1SDA102829R1	1SDA102830R1		1SDA102831R1

Note: When a single code for the complete circuit-breaker is not available, please configure the breaking part code with the trip unit code to order a factory-assembled circuit-breaker

Ordering codes for XT6

Automatic circuit-breakers



XT6 - circuit-breaker

Distribution circuit-breakers

SACE XT6N (35kA) TMA- Front terminals (F)

Size	lu	Trip units	In	Type	3 poles		4 poles	
					Code		Code	
XT6	800	TMA	600	XT6N 800 TMA 600-6000	1SDA107625R1		1SDA107646R1	
			800		XT6N 800 TMA 800-8000	1SDA102839R1		1SDA102860R1

SACE XT6N (35kA) Ekip Dip LS/I - Front terminals (F)

Size	lu	Trip units	In	Type	3 poles		4 poles	
					Code		Code	
XT6	800	Ekip Dip LS/I	600	XT6N 800 Ekip Dip LS/I In=600A	1SDA107626R1		1SDA107647R1	
			800		XT6N 800 Ekip Dip LS/I In=800A	1SDA102840R1		1SDA102861R1

SACE XT6N (35kA) Ekip Dip LSI - Front terminals (F)

Size	lu	Trip units	In	Type	3 poles		4 poles	
					Code		Code	
XT6	800	Ekip Dip LSI	600	XT6N 800 Ekip Dip LSI In=600A	1SDA107627R1		1SDA107648R1	
			800		XT6N 800 Ekip Dip LSI In=800A	1SDA102841R1		1SDA102862R1

SACE XT6N (35kA) Ekip Dip LSIG - Front terminals (F)

Size	lu	Trip units	In	Type	3 poles		4 poles	
					Code		Code	
XT6	800	Ekip Dip LSIG	600	XT6N 800 Ekip Dip LSIG In=600A	1SDA107628R1		1SDA107649R1	
			800		XT6N 800 Ekip Dip LSIG In=800A	1SDA102842R1		1SDA102863R1

SACE XT6N (35kA) Ekip Dip LIG - Front terminals (F)

Size	lu	Trip units	In	Type	3 poles		4 poles	
					Code		Code	
XT6	800	Ekip Dip LIG	600	XT6N 800 Ekip Dip LIG In=600A	1SDA107631R1		1SDA107650R1	
			800		XT6N 800 Ekip Dip LIG In=800A	1SDA102845R1		1SDA102864R1

Motor protection circuit-breaker (MCP)

SACE XT6N (35kA) Ekip M Dip I - Front terminals (F)

Size	lu	Trip units	In	Type	3 poles	
					Code	
XT6	800	Ekip M Dip I	600	XT6N 800 Ekip M Dip I In=600A	1SDA107629R1	
			800		XT6N 800 Ekip M Dip I In=800A	1SDA102843R1

Motor protection circuit-breaker (MPCB)

SACE XT6N (35kA) Ekip M Dip LIU - Front terminals (F)

Size	lu	Trip units	In	Type	3 poles	
					Code	
XT6	800	Ekip M Dip LIU	600	XT6N 800 Ekip M Dip LIU In=600A	1SDA107630R1	
			800		XT6N 800 Ekip M Dip LIU In=800A	1SDA102844R1

Ordering codes for XT6

Automatic circuit-breakers



XT6 - circuit-breaker

Distribution circuit-breakers

SACE XT6S (50kA) TMA- Front terminals (F)

Size	lu	Trip units	In	Type	3 poles	4 poles
					Code	Code
XT6	800	TMA	600	XT6S 800 TMA 600-6000	1SDA107632R1	1SDA107651R1
			800		1SDA102846R1	1SDA102865R1

SACE XT6S (50kA) Ekip Dip LS/I - Front terminals (F)

Size	lu	Trip units	In	Type	3 poles	4 poles
					Code	Code
XT6	800	Ekip Dip LS/I	600	XT6S 800 Ekip Dip LS/I In=600A	1SDA107633R1	1SDA107652R1
			800		1SDA102847R1	1SDA102866R1

SACE XT6S (50kA) Ekip Dip LSI - Front terminals (F)

Size	lu	Trip units	In	Type	3 poles	4 poles
					Code	Code
XT6	800	Ekip Dip LSI	600	XT6S 800 Ekip Dip LSI In=600A	1SDA107634R1	1SDA107653R1
			800		1SDA102848R1	1SDA102867R1

SACE XT6S (50kA) Ekip Dip LSIG - Front terminals (F)

Size	lu	Trip units	In	Type	3 poles	4 poles
					Code	Code
XT6	800	Ekip Dip LSIG	600	XT6S 800 Ekip Dip LSIG In=600A	1SDA107635R1	1SDA107654R1
			800		1SDA102849R1	1SDA102868R1

SACE XT6S (50kA) Ekip Dip LIG - Front terminals (F)

Size	lu	Trip units	In	Type	3 poles	4 poles
					Code	Code
XT6	800	Ekip Dip LIG	600	XT6S 800 Ekip Dip LIG In=600A	1SDA107638R1	1SDA107655R1
			800		1SDA102852R1	1SDA102869R1

Motor protection circuit-breaker (MCP)

SACE XT6S (50kA) Ekip M Dip I - Front terminals (F)

Size	lu	Trip units	In	Type	3 poles
					Code
XT6	800	Ekip M Dip I	600	XT6S 800 Ekip M Dip I In=600A	1SDA107636R1
			800		1SDA102850R1

Motor protection circuit-breaker (MPCB)

SACE XT6S (50kA) Ekip M Dip LIU - Front terminals (F)

Size	lu	Trip units	In	Type	3 poles
					Code
XT6	800	Ekip M Dip LIU	600	XT6S 800 Ekip M Dip LIU In=600A	1SDA107637R1
			800		1SDA102851R1



XT6 - circuit-breaker

Distribution circuit-breakers

SACE XT6H (65kA) TMA- Front terminals (F)

Size	lu	Trip units	In	Type	3 poles	4 poles
					Code	Code
XT6	800	TMA	600	XT6H 800 TMA 600-6000	1SDA107639R1	1SDA107656R1
			800		1SDA102853R1	1SDA102870R1

SACE XT6H (65kA) Ekip Dip LS/I - Front terminals (F)

Size	lu	Trip units	In	Type	3 poles	4 poles
					Code	Code
XT6	800	Ekip Dip LS/I	600	XT6H 800 Ekip Dip LS/I In=600A	1SDA107640R1	1SDA107657R1
			800		1SDA102854R1	1SDA102871R1

SACE XT6H (65kA) Ekip Dip LSI - Front terminals (F)

Size	lu	Trip units	In	Type	3 poles	4 poles
					Code	Code
XT6	800	Ekip Dip LSI	600	XT6H 800 Ekip Dip LSI In=600A	1SDA107641R1	1SDA107658R1
			800		1SDA102855R1	1SDA102872R1

SACE XT6H (65kA) Ekip Dip LSIG - Front terminals (F)

Size	lu	Trip units	In	Type	3 poles	4 poles
					Code	Code
XT6	800	Ekip Dip LSIG	600	XT6H 800 Ekip Dip LSIG In=600A	1SDA107642R1	1SDA107659R1
			800		1SDA102856R1	1SDA102873R1

SACE XT6H (65kA) Ekip Dip LIG - Front terminals (F)

Size	lu	Trip units	In	Type	3 poles	4 poles
					Code	Code
XT6	800	Ekip Dip LIG	600	XT6H 800 Ekip Dip LIG In=600A	1SDA107645R1	1SDA107660R1
			800		1SDA102859R1	1SDA102874R1

Motor protection circuit-breaker (MCP)

SACE XT6H (65kA) Ekip M Dip I - Front terminals (F)

Size	lu	Trip units	In	Type	3 poles
					Code
XT6	800	Ekip M Dip I	600	XT6H 800 Ekip M Dip I In=600A	1SDA107643R1
			800		1SDA102857R1

Motor protection circuit-breaker (MPCB)

SACE XT6H (65kA) Ekip M Dip LIU - Front terminals (F)

Size	lu	Trip units	In	Type	3 poles
					Code
XT6	800	Ekip M Dip LIU	600	XT6H 800 Ekip M Dip LIU In=600A	1SDA107644R1
			800		1SDA102858R1

Ordering codes for XT6

Automatic circuit-breakers

Molded case switches

SACE XT6D - MCS



XT6 - circuit-breaker

Size lu	Type	3 poles	4 poles
		Code	Code
XT6 800	XT6N-D 800	1SDA102875R1	1SDA102878R1
	XT6S-D 800	1SDA102876R1	1SDA102879R1
	XT6H-D 800	1SDA102877R1	1SDA102880R1

Ordering codes for XT6

Breaking part



XT6 - breaking part

SACE XT6 - Breaking part

Size	Iu	Icu (480V)	Type	3 poles	4 poles
				Code	Code
XT6	800	35	XT6N 400 BREAKING PART	1SDA102881R1	1SDA102884R1
		50	XT6S 600 BREAKING PART	1SDA102882R1	1SDA102885R1
		65	XT6H 400 BREAKING PART	1SDA102883R1	1SDA102886R1

100% rated distribution circuit-breakers

100% rated version extra code

Size	3 poles	4 poles
	Code	Code
XT6	1SDA112975R1	1SDA112976R1

Note: to be specified only in addition to the code of the automatic circuit-breaker or of the breaking part

Ordering codes for XT6

Trip units



Thermal magnetic
trip unit

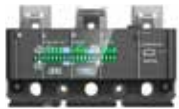

Dip trip unit

Trip units - distribution protection

Size	Type	3 poles	4 poles
		Code	Code
XT6	TMA 600-6000	1SDA107661R1	1SDA107666R1
	TMA 800-8000	1SDA102887R1	1SDA102894R1
	Ekip Dip LS/I In=600A	1SDA107662R1	1SDA107667R1
	Ekip Dip LS/I In=800A	1SDA102888R1	1SDA102895R1
	Ekip Dip LSI In=600A	1SDA107663R1	1SDA107668R1
	Ekip Dip LSI In=800A	1SDA102889R1	1SDA102896R1
	Ekip Dip LSIG In=600A	1SDA107664R1	1SDA107669R1
	Ekip Dip LSIG In=800A	1SDA102890R1	1SDA102897R1
	Ekip Dip LIG In=600A	1SDA107665R1	1SDA107670R1
	Ekip Dip LIG In=800A	1SDA102893R1	1SDA102898R1

Trip units - Generator protection

Size	Type	3 poles	4 poles
		Code	Code
XT6	Ekip G Dip LS/I In=600	1SDA107673R1	1SDA107674R1
	Ekip G Dip LS/I In=800	1SDA107484R1	1SDA107485R1

Ordering codes for XT6

Breaking part + trip unit solution



XT6 Breaking part



Thermal-Magnetic Trip unit



Ekip Dip Trip Unit



Thermal-Magnetic Trip unit

Breaking Part	Iu	Icu Poles	N (25kA)	S (35kA)	H (65kA)
			800	3	1SDA102881R1
		4	1SDA102884R1	1SDA102885R1	1SDA102886R1

Trip units	In Poles	600	800
		TMA	3
	4	1SDA107666R1	1SDA102894R1
Ekip Dip LS/I	3	1SDA107662R1	1SDA102888R1
	4	1SDA107667R1	1SDA102895R1
Ekip Dip LSI	3	1SDA107663R1	1SDA102889R1
	4	1SDA107668R1	1SDA102896R1
Ekip Dip LSIG	3	1SDA107664R1	1SDA102890R1
	4	1SDA107669R1	1SDA102897R1
Ekip Dip LIG	3	1SDA107665R1	1SDA102893R1
	4	1SDA107670R1	1SDA102898R1
Ekip G Dip LS/I	3	1SDA107673R1	1SDA107484R1
	4	1SDA107674R1	1SDA107485R1

Note: When a single code for the complete circuit-breaker is not available, please configure the breaking part code with the trip unit code to order a factory-assembled circuit-breaker

Ordering codes for XT7/XT7 M

Automatic circuit-breakers – XT7



XT7 - circuit-breaker

Distribution circuit-breakers

SACE XT7S (50kA) Ekip Dip LS/I - Front terminal (F)

Size	lu	Trip units	In	Type	3 poles	4 poles
					Code	Code
XT7	800	Ekip Dip LS/I	800	XT7S 800 Ekip Dip LS/I In=800A	1SDA102899R1	1SDA103139R1
	1000	Ekip Dip LS/I	1000	XT7S 1000 Ekip Dip LS/I In=1000A	1SDA102900R1	1SDA103140R1
	1200	Ekip Dip LS/I	1200	XT7S 1200 Ekip Dip LS/I In=1200A	1SDA102901R1	1SDA103141R1

SACE XT7S (50kA) Ekip Dip LSI - Front terminal (F)

Size	lu	Trip units	In	Type	3 poles	4 poles
					Code	Code
XT7	800	Ekip Dip LSI	800	XT7S 800 Ekip Dip LSI In=800A	1SDA102902R1	1SDA103142R1
	1000	Ekip Dip LSI	1000	XT7S 1000 Ekip Dip LSI In=1000A	1SDA102903R1	1SDA103143R1
	1200	Ekip Dip LSI	1200	XT7S 1200 Ekip Dip LSI In=1200A	1SDA102904R1	1SDA103144R1

SACE XT7S (50kA) Ekip Dip LSIG - Front terminal (F)

Size	lu	Trip units	In	Type	3 poles	4 poles
					Code	Code
XT7	800	Ekip Dip LSIG	800	XT7S 800 Ekip Dip LSIG In=800A	1SDA102905R1	1SDA103145R1
	1000	Ekip Dip LSIG	1000	XT7S 1000 Ekip Dip LSIG In=1000A	1SDA102906R1	1SDA103146R1
	1200	Ekip Dip LSIG	1200	XT7S 1200 Ekip Dip LSIG In=1200A	1SDA102907R1	1SDA103147R1

SACE XT7S (50kA) Ekip Dip LIG - Front terminal (F)

Size	lu	Trip units	In	Type	3 poles	4 poles
					Code	Code
XT7	800	Ekip Dip LIG	800	XT7S 800 Ekip Dip LIG In=800A	1SDA102944R1	1SDA103178R1
	1000	Ekip Dip LIG	1000	XT7S 1000 Ekip Dip LIG In=1000A	1SDA102945R1	1SDA103179R1
	1200	Ekip Dip LIG	1200	XT7S 1200 Ekip Dip LIG In=1200A	1SDA102946R1	1SDA103180R1

SACE XT7S (50kA) Ekip Touch LSI - Front terminal (F)

Size	lu	Trip units	In	Type	3 poles	4 poles
					Code	Code
XT7	800	Ekip Touch LSI	800	XT7S 800 Ekip Touch LSI In=800A	1SDA102908R1	1SDA103148R1
	1000	Ekip Touch LSI	1000	XT7S 1000 Ekip Touch LSI In=1000A	1SDA102909R1	1SDA103149R1
	1200	Ekip Touch LSI	1200	XT7S 1200 Ekip Touch LSI In=1200A	1SDA102910R1	1SDA103150R1



XT7 - circuit-breaker

SACE XT7S (50kA) Ekip Touch LSIg - Front terminal (F)

Size	Iu	Trip units	In	Type	3 poles	4 poles
					Code	Code
XT7	800	Ekip Touch LSIg	800	XT7S 800 Ekip Touch LSIg In=800A	1SDA102911R1	1SDA103151R1
	1000	Ekip Touch LSIg	1000	XT7S 1000 Ekip Touch LSIg In=1000A	1SDA102912R1	1SDA103152R1
	1200	Ekip Touch LSIg	1200	XT7S 1200 Ekip Touch LSIg In=1200A	1SDA102913R1	1SDA103153R1

SACE XT7S (50kA) Ekip Touch Measuring LSI - Front terminal (F)

Size	Iu	Trip units	In	Type	3 poles	4 poles
					Code	Code
XT7	800	Ekip Touch Meas. LSI	800	XT7S 800 Ekip Touch Meas. LSI In=800A	1SDA102914R1	1SDA103154R1
	1000	Ekip Touch Meas. LSI	1000	XT7S 1000 Ekip Touch Meas. LSI In=1000A	1SDA102915R1	1SDA103155R1
	1200	Ekip Touch Meas. LSI	1200	XT7S 1200 Ekip Touch Meas. LSI In=1200A	1SDA102916R1	1SDA103156R1

SACE XT7S (50kA) Ekip Touch Measuring LSIg - Front terminal (F)

Size	Iu	Trip units	In	Type	3 poles	4 poles
					Code	Code
XT7	800	Ekip Touch Meas. LSIg	800	XT7S 800 Ekip Touch Meas. LSIg In=800A	1SDA102917R1	1SDA103157R1
	1000	Ekip Touch Meas. LSIg	1000	XT7S 1000 Ekip Touch Meas. LSIg In=1000A	1SDA102918R1	1SDA103158R1
	1200	Ekip Touch Meas. LSIg	1200	XT7S 1200 Ekip Touch Meas. LSIg In=1200A	1SDA102919R1	1SDA103159R1

SACE XT7S (50kA) Ekip Hi-Touch LSI - Front terminal (F)

Size	Iu	Trip units	In	Type	3 poles	4 poles
					Code	Code
XT7	800	Ekip Hi-Touch LSI	800	XT7S 800 Ekip Hi-Touch LSI In=800A	1SDA102920R1	1SDA103160R1
	1000	Ekip Hi-Touch LSI	1000	XT7S 1000 Ekip Hi-Touch LSI In=1000A	1SDA102921R1	1SDA103161R1
	1200	Ekip Hi-Touch LSI	1200	XT7S 1200 Ekip Hi-Touch LSI In=1200A	1SDA102922R1	1SDA103162R1

SACE XT7S (50kA) Ekip Hi-Touch LSIg - Front terminal (F)

Size	Iu	Trip units	In	Type	3 poles	4 poles
					Code	Code
XT7	800	Ekip Hi-Touch LSIg	800	XT7S 800 Ekip Hi-Touch LSIg In=800A	1SDA102923R1	1SDA103163R1
	1000	Ekip Hi-Touch LSIg	1000	XT7S 1000 Ekip Hi-Touch LSIg In=1000A	1SDA102924R1	1SDA103164R1
	1200	Ekip Hi-Touch LSIg	1200	XT7S 1200 Ekip Hi-Touch LSIg In=1200A	1SDA102925R1	1SDA103165R1

Ordering codes for XT7/XT7 M

Automatic circuit-breakers – XT7



XT7 - circuit-breaker

Motor protection circuit-breaker (MCP)

SACE XT7S (50kA) Ekip M Dip I - Front terminal (F)

Size	Iu	Trip units	In	Type	3 poles	4 poles
					Code	Code
XT7	800	Ekip M Dip I	800	XT7S 800 Ekip M Dip I In=800A	1SDA102926R1	
	1000	Ekip M Dip I	1000	XT7S 1000 Ekip M Dip I In=1000A	1SDA102927R1	
	1200	Ekip M Dip I	1200	XT7S 1200 Ekip M Dip I In=1200A	1SDA102928R1	

Motor protection circuit-breaker (MPCB)

SACE XT7S (50kA) Ekip M Touch LRIU - Front terminal (F)

Size	Iu	Trip units	In	Type	3 poles	4 poles
					Code	Code
XT7	800	Ekip M Touch LRIU	800	XT7S 800 Ekip M Touch LRIU In=800A	1SDA102929R1	
	1000	Ekip M Touch LRIU	1000	XT7S 1000 Ekip M Touch LRIU In=1000A	1SDA102930R1	
	1200	Ekip M Touch LRIU	1200	XT7S 1200 Ekip M Touch LRIU In=1200A	1SDA102931R1	

Generator protection circuit-breaker



XT7 - circuit-breaker

SACE XT7S (50kA) Ekip G Dip LS/I - Front terminal (F)

Size	Iu	Trip units	In	Type	3 poles	4 poles
					Code	Code
XT7	800	Ekip G Dip LS/I	800	XT7S 800 Ekip G Dip LS/I In=800A	1SDA102932R1	1SDA103166R1
	1000	Ekip G Dip LS/I	1000	XT7S 1000 Ekip G Dip LS/I In=1000A	1SDA102933R1	1SDA103167R1
	1200	Ekip G Dip LS/I	1200	XT7S 1200 Ekip G Dip LS/I In=1200A	1SDA102934R1	1SDA103168R1

SACE XT7S (50kA) Ekip G Touch LSIG - Front terminal (F)

Size	Iu	Trip units	In	Type	3 poles	4 poles
					Code	Code
XT7	800	Ekip G Touch LSIG	800	XT7S 800 Ekip G Touch LSIG In=800A	1SDA102935R1	1SDA103169R1
	1000	Ekip G Touch LSIG	1000	XT7S 1000 Ekip G Touch LSIG In=1000A	1SDA102936R1	1SDA103170R1
	1200	Ekip G Touch LSIG	1200	XT7S 1200 Ekip G Touch LSIG In=1200A	1SDA102937R1	1SDA103171R1

SACE XT7S (50kA) Ekip G Hi-Touch LSIG - Front terminal (F)

Size	Iu	Trip units	In	Type	3 poles	4 poles
					Code	Code
XT7	800	Ekip G Hi-Touch LSIG	800	XT7S 800 Ekip G Hi-Touch LSIG In=800A	1SDA102938R1	1SDA103172R1
	1000	Ekip G Hi-Touch LSIG	1000	XT7S 1000 Ekip G Hi-Touch LSIG In=1000A	1SDA102939R1	1SDA103173R1
	1200	Ekip G Hi-Touch LSIG	1200	XT7S 1200 Ekip G Hi-Touch LSIG In=1200A	1SDA102940R1	1SDA103174R1

Ordering codes for XT7/XT7 M

Automatic circuit-breakers – XT7



XT7 - circuit-breaker

Distribution circuit-breaker

SACE XT7H (65kA) Ekip Dip LS/I - Front terminal (F)

Size	lu	Trip units	In	Type	3 poles	4 poles
					Code	Code
XT7	800	Ekip Dip LS/I	800	XT7H 800 Ekip Dip LS/I In=800A	1SDA102947R1	1SDA103181R1
	1000	Ekip Dip LS/I	1000	XT7H 1000 Ekip Dip LS/I In=1000A	1SDA102948R1	1SDA103182R1
	1200	Ekip Dip LS/I	1200	XT7H 1200 Ekip Dip LS/I In=1200A	1SDA102949R1	1SDA103183R1

SACE XT7H (65kA) Ekip Dip LSI - Front terminal (F)

Size	lu	Trip units	In	Type	3 poles	4 poles
					Code	Code
XT7	800	Ekip Dip LSI	800	XT7H 800 Ekip Dip LSI In=800A	1SDA102950R1	1SDA103184R1
	1000	Ekip Dip LSI	1000	XT7H 1000 Ekip Dip LSI In=1000A	1SDA102951R1	1SDA103185R1
	1200	Ekip Dip LSI	1200	XT7H 1200 Ekip Dip LSI In=1200A	1SDA102952R1	1SDA103186R1

SACE XT7H (65kA) Ekip Dip LSIG - Front terminal (F)

Size	lu	Trip units	In	Type	3 poles	4 poles
					Code	Code
XT7	800	Ekip Dip LSIG	800	XT7H 800 Ekip Dip LSIG In=800A	1SDA102953R1	1SDA103187R1
	1000	Ekip Dip LSIG	1000	XT7H 1000 Ekip Dip LSIG In=1000A	1SDA102954R1	1SDA103188R1
	1200	Ekip Dip LSIG	1200	XT7H 1200 Ekip Dip LSIG In=1200A	1SDA102955R1	1SDA103189R1

SACE XT7H (65kA) Ekip Dip LIG - Front terminal (F)

Size	lu	Trip units	In	Type	3 poles	4 poles
					Code	Code
XT7	800	Ekip Dip LIG	800	XT7H 800 Ekip Dip LIG In=800A	1SDA102992R1	1SDA103220R1
	1000	Ekip Dip LIG	1000	XT7H 1000 Ekip Dip LIG In=1000A	1SDA102993R1	1SDA103221R1
	1200	Ekip Dip LIG	1200	XT7H 1200 Ekip Dip LIG In=1200A	1SDA102994R1	1SDA103222R1

SACE XT7H (65kA) Ekip Touch LSI - Front terminal (F)

Size	lu	Trip units	In	Type	3 poles	4 poles
					Code	Code
XT7	800	Ekip Touch LSI	800	XT7H 800 Ekip Touch LSI In=800A	1SDA102956R1	1SDA103190R1
	1000	Ekip Touch LSI	1000	XT7H 1000 Ekip Touch LSI In=1000A	1SDA102957R1	1SDA103191R1
	1200	Ekip Touch LSI	1200	XT7H 1200 Ekip Touch LSI In=1200A	1SDA102958R1	1SDA103192R1



XT7 - circuit-breaker

SACE XT7H (65kA) Ekip Touch LSIg - Front terminal (F)

Size	Iu	Trip units	In	Type	3 poles	4 poles
					Code	Code
XT7	800	Ekip Touch LSIg	800	XT7H 800 Ekip Touch LSIg In=800A	1SDA102959R1	1SDA103193R1
	1000	Ekip Touch LSIg	1000	XT7H 1000 Ekip Touch LSIg In=1000A	1SDA102960R1	1SDA103194R1
	1200	Ekip Touch LSIg	1200	XT7H 1200 Ekip Touch LSIg In=1200A	1SDA102961R1	1SDA103195R1

SACE XT7H (65kA) Ekip Touch Measuring LSI - Front terminal (F)

Size	Iu	Trip units	In	Type	3 poles	4 poles
					Code	Code
XT7	800	Ekip Touch Meas. LSI	800	XT7H 800 Ekip Touch Meas. LSI In=800A	1SDA102962R1	1SDA103196R1
	1000	Ekip Touch Meas. LSI	1000	XT7H 1000 Ekip Touch Meas. LSI In=1000A	1SDA102963R1	1SDA103197R1
	1200	Ekip Touch Meas. LSI	1200	XT7H 1200 Ekip Touch Meas. LSI In=1200A	1SDA102964R1	1SDA103198R1

SACE XT7H (65kA) Ekip Touch Measuring LSIg - Front terminal (F)

Size	Iu	Trip units	In	Type	3 poles	4 poles
					Code	Code
XT7	800	Ekip Touch Meas. LSIg	800	XT7H 800 Ekip Touch Meas. LSIg In=800A	1SDA102965R1	1SDA103199R1
	1000	Ekip Touch Meas. LSIg	1000	XT7H 1000 Ekip Touch Meas. LSIg In=1000A	1SDA102966R1	1SDA103200R1
	1200	Ekip Touch Meas. LSIg	1200	XT7H 1200 Ekip Touch Meas. LSIg In=1200A	1SDA102967R1	1SDA103201R1

SACE XT7H (65kA) Ekip Hi-Touch LSI - Front terminal (F)

Size	Iu	Trip units	In	Type	3 poles	4 poles
					Code	Code
XT7	800	Ekip Hi-Touch LSI	800	XT7H 800 Ekip Hi-Touch LSI In=800A	1SDA102968R1	1SDA103202R1
	1000	Ekip Hi-Touch LSI	1000	XT7H 1000 Ekip Hi-Touch LSI In=1000A	1SDA102969R1	1SDA103203R1
	1200	Ekip Hi-Touch LSI	1200	XT7H 1200 Ekip Hi-Touch LSI In=1200A	1SDA102970R1	1SDA103204R1

SACE XT7H (65kA) Ekip Hi-Touch LSIg - Front terminal (F)

Size	Iu	Trip units	In	Type	3 poles	4 poles
					Code	Code
XT7	800	Ekip Hi-Touch LSIg	800	XT7H 800 Ekip Hi-Touch LSIg In=800A	1SDA102971R1	1SDA103205R1
	1000	Ekip Hi-Touch LSIg	1000	XT7H 1000 Ekip Hi-Touch LSIg In=1000A	1SDA102972R1	1SDA103206R1
	1200	Ekip Hi-Touch LSIg	1200	XT7H 1200 Ekip Hi-Touch LSIg In=1200A	1SDA102973R1	1SDA103207R1

Ordering codes for XT7/XT7 M

Automatic circuit-breakers – XT7



XT7 - circuit-breaker

Motor protection circuit-breaker (MCP)

SACE XT7H (65kA) Ekip M Dip I - Front terminal (F)

Size	Iu	Trip units	In	Type	3 poles	4 poles
					Code	Code
XT7	800	Ekip M Dip I	800	XT7H 800 Ekip M Dip I In=800A	1SDA102974R1	
	1000	Ekip M Dip I	1000	XT7H 1000 Ekip M Dip I In=1000A	1SDA102975R1	
	1200	Ekip M Dip I	1200	XT7H 1200 Ekip M Dip I In=1200A	1SDA102976R1	

Motor protection circuit-breaker (MPCB)

SACE XT7H (65kA) Ekip M Touch LRIU - Front terminal (F)

Size	Iu	Trip units	In	Type	3 poles	4 poles
					Code	Code
XT7	800	Ekip M Touch LRIU	800	XT7H 800 Ekip M Touch LRIU In=800A	1SDA102977R1	
	1000	Ekip M Touch LRIU	1000	XT7H 1000 Ekip M Touch LRIU In=1000A	1SDA102978R1	
	1200	Ekip M Touch LRIU	1200	XT7H 1200 Ekip M Touch LRIU In=1200A	1SDA102979R1	

Generator protection circuit-breaker



XT7 - circuit-breaker

SACE XT7H (65kA) Ekip G Dip LS/I - Front terminal (F)

Size	Iu	Trip units	In	Type	3 poles	4 poles
					Code	Code
XT7	800	Ekip G Dip LS/I	800	XT7H 800 Ekip G Dip LS/I In=800A	1SDA102980R1	1SDA103208R1
	1000	Ekip G Dip LS/I	1000	XT7H 1000 Ekip G Dip LS/I In=1000A	1SDA102981R1	1SDA103209R1
	1200	Ekip G Dip LS/I	1200	XT7H 1200 Ekip G Dip LS/I In=1200A	1SDA102982R1	1SDA103210R1

SACE XT7H (65kA) Ekip G Touch LSIG - Front terminal (F)

Size	Iu	Trip units	In	Type	3 poles	4 poles
					Code	Code
XT7	800	Ekip G Touch LSIG	800	XT7H 800 Ekip G Touch LSIG In=800A	1SDA102983R1	1SDA103211R1
	1000	Ekip G Touch LSIG	1000	XT7H 1000 Ekip G Touch LSIG In=1000A	1SDA102984R1	1SDA103212R1
	1200	Ekip G Touch LSIG	1200	XT7H 1200 Ekip G Touch LSIG In=1200A	1SDA102985R1	1SDA103213R1

SACE XT7H (65kA) Ekip G Hi-Touch LSIG - Front terminal (F)

Size	Iu	Trip units	In	Type	3 poles	4 poles
					Code	Code
XT7	800	Ekip G Hi-Touch LSIG	800	XT7H 800 Ekip G Hi-Touch LSIG In=800A	1SDA102986R1	1SDA103214R1
	1000	Ekip G Hi-Touch LSIG	1000	XT7H 1000 Ekip G Hi-Touch LSIG In=1000A	1SDA102987R1	1SDA103215R1
	1200	Ekip G Hi-Touch LSIG	1200	XT7H 1200 Ekip G Hi-Touch LSIG In=1200A	1SDA102988R1	1SDA103216R1

Ordering codes for XT7/XT7 M

Automatic circuit-breakers – XT7



XT7 - circuit-breaker

Distribution circuit-breaker

SACE XT7L (100kA) Ekip Dip LS/I - Front terminal (F)

Size	lu	Trip units	In	Type	3 poles	4 poles
					Code	Code
XT7	800	Ekip Dip LS/I	800	XT7L 800 Ekip Dip LS/I In=800A	1SDA102995R1	1SDA103223R1
	1000	Ekip Dip LS/I	1000	XT7L 1000 Ekip Dip LS/I In=1000A	1SDA102996R1	1SDA103224R1
	1200	Ekip Dip LS/I	1200	XT7L 1200 Ekip Dip LS/I In=1200A	1SDA102997R1	1SDA103225R1

SACE XT7L (100kA) Ekip Dip LSI - Front terminal (F)

Size	lu	Trip units	In	Type	3 poles	4 poles
					Code	Code
XT7	800	Ekip Dip LSI	800	XT7L 800 Ekip Dip LSI In=800A	1SDA102998R1	1SDA103226R1
	1000	Ekip Dip LSI	1000	XT7L 1000 Ekip Dip LSI In=1000A	1SDA102999R1	1SDA103227R1
	1200	Ekip Dip LSI	1200	XT7L 1200 Ekip Dip LSI In=1200A	1SDA103000R1	1SDA103228R1

SACE XT7L (100kA) Ekip Dip LSIG - Front terminal (F)

Size	lu	Trip units	In	Type	3 poles	4 poles
					Code	Code
XT7	800	Ekip Dip LSIG	800	XT7L 800 Ekip Dip LSIG In=800A	1SDA103001R1	1SDA103229R1
	1000	Ekip Dip LSIG	1000	XT7L 1000 Ekip Dip LSIG In=1000A	1SDA103002R1	1SDA103230R1
	1200	Ekip Dip LSIG	1200	XT7L 1200 Ekip Dip LSIG In=1200A	1SDA103003R1	1SDA103231R1

SACE XT7L (100kA) Ekip Dip LIG - Front terminal (F)

Size	lu	Trip units	In	Type	3 poles	4 poles
					Code	Code
XT7	800	Ekip Dip LIG	800	XT7L 800 Ekip Dip LIG In=800A	1SDA103040R1	1SDA103262R1
	1000	Ekip Dip LIG	1000	XT7L 1000 Ekip Dip LIG In=1000A	1SDA103041R1	1SDA103263R1
	1200	Ekip Dip LIG	1200	XT7L 1200 Ekip Dip LIG In=1200A	1SDA103042R1	1SDA103264R1

SACE XT7L (100kA) Ekip Touch LSI - Front terminal (F)

Size	lu	Trip units	In	Type	3 poles	4 poles
					Code	Code
XT7	800	Ekip Touch LSI	800	XT7L 800 Ekip Touch LSI In=800A	1SDA103004R1	1SDA103232R1
	1000	Ekip Touch LSI	1000	XT7L 1000 Ekip Touch LSI In=1000A	1SDA103005R1	1SDA103233R1
	1200	Ekip Touch LSI	1200	XT7L 1200 Ekip Touch LSI In=1200A	1SDA103006R1	1SDA103234R1



XT7 - circuit-breaker

SACE XT7L (100kA) Ekip Touch LSI - Front terminal (F)

Size	Iu	Trip units	In	Type	3 poles	4 poles
					Code	Code
XT7	800	Ekip Touch LSI	800	XT7L 800 Ekip Touch LSI In=800A	1SDA103007R1	1SDA103235R1
	1000	Ekip Touch LSI	1000	XT7L 1000 Ekip Touch LSI In=1000A	1SDA103008R1	1SDA103236R1
	1200	Ekip Touch LSI	1200	XT7L 1200 Ekip Touch LSI In=1200A	1SDA103009R1	1SDA103237R1

SACE XT7L (100kA) Ekip Touch Measuring LSI - Front terminal (F)

Size	Iu	Trip units	In	Type	3 poles	4 poles
					Code	Code
XT7	800	Ekip Touch Meas. LSI	800	XT7L 800 Ekip Touch Meas. LSI In=800A	1SDA103010R1	1SDA103238R1
	1000	Ekip Touch Meas. LSI	1000	XT7L 1000 Ekip Touch Meas. LSI In=1000A	1SDA103011R1	1SDA103239R1
	1200	Ekip Touch Meas. LSI	1200	XT7L 1200 Ekip Touch Meas. LSI In=1200A	1SDA103012R1	1SDA103240R1

SACE XT7L (100kA) Ekip Touch Measuring LSI - Front terminal (F)

Size	Iu	Trip units	In	Type	3 poles	4 poles
					Code	Code
XT7	800	Ekip Touch Meas. LSI	800	XT7L 800 Ekip Touch Meas. LSI In=800A	1SDA103013R1	1SDA103241R1
	1000	Ekip Touch Meas. LSI	1000	XT7L 1000 Ekip Touch Meas. LSI In=1000A	1SDA103014R1	1SDA103242R1
	1200	Ekip Touch Meas. LSI	1200	XT7L 1200 Ekip Touch Meas. LSI In=1200A	1SDA103015R1	1SDA103243R1

SACE XT7L (100kA) Ekip Hi-Touch LSI - Front terminal (F)

Size	Iu	Trip units	In	Type	3 poles	4 poles
					Code	Code
XT7	800	Ekip Hi-Touch LSI	800	XT7L 800 Ekip Hi-Touch LSI In=800A	1SDA103016R1	1SDA103244R1
	1000	Ekip Hi-Touch LSI	1000	XT7L 1000 Ekip Hi-Touch LSI In=1000A	1SDA103017R1	1SDA103245R1
	1200	Ekip Hi-Touch LSI	1200	XT7L 1200 Ekip Hi-Touch LSI In=1200A	1SDA103018R1	1SDA103246R1

SACE XT7L (100kA) Ekip Hi-Touch LSI - Front terminal (F)

Size	Iu	Trip units	In	Type	3 poles	4 poles
					Code	Code
XT7	800	Ekip Hi-Touch LSI	800	XT7L 800 Ekip Hi-Touch LSI In=800A	1SDA103019R1	1SDA103247R1
	1000	Ekip Hi-Touch LSI	1000	XT7L 1000 Ekip Hi-Touch LSI In=1000A	1SDA103020R1	1SDA103248R1
	1200	Ekip Hi-Touch LSI	1200	XT7L 1200 Ekip Hi-Touch LSI In=1200A	1SDA103021R1	1SDA103249R1

Ordering codes for XT7/XT7 M

Automatic circuit-breakers – XT7



XT7 - circuit-breaker

Motor protection circuit-breaker (MCP)

SACE XT7L (100kA) Ekip M Dip I - Front terminal (F)

Size	Iu	Trip units	In	Type	3 poles	4 poles
					Code	Code
XT7	800	Ekip M Dip I	800	XT7L 800 Ekip M Dip I In=800A	1SDA103022R1	
	1000	Ekip M Dip I	1000	XT7L 1000 Ekip M Dip I In=1000A	1SDA103023R1	
	1200	Ekip M Dip I	1200	XT7L 1200 Ekip M Dip I In=1200A	1SDA103024R1	

Motor protection circuit-breaker (MPCB)

SACE XT7L (100kA) Ekip M Touch LRIU - Front terminal (F)

Size	Iu	Trip units	In	Type	3 poles	4 poles
					Code	Code
XT7	800	Ekip M Touch LRIU	800	XT7L 800 Ekip M Touch LRIU In=800A	1SDA103025R1	
	1000	Ekip M Touch LRIU	1000	XT7L 1000 Ekip M Touch LRIU In=1000A	1SDA103026R1	
	1200	Ekip M Touch LRIU	1200	XT7L 1200 Ekip M Touch LRIU In=1200A	1SDA103027R1	

Generator protection circuit-breaker



XT7 - circuit-breaker

SACE XT7L (100kA) Ekip G Dip LS/I - Front terminal (F)

Size	Iu	Trip units	In	Type	3 poles	4 poles
					Code	Code
XT7	800	Ekip G Dip LS/I	800	XT7L 800 Ekip G Dip LS/I In=800A	1SDA103028R1	1SDA103250R1
	1000	Ekip G Dip LS/I	1000	XT7L 1000 Ekip G Dip LS/I In=1000A	1SDA103029R1	1SDA103251R1
	1200	Ekip G Dip LS/I	1200	XT7L 1200 Ekip G Dip LS/I In=1200A	1SDA103030R1	1SDA103252R1

SACE XT7L (100kA) Ekip G Touch LSIG - Front terminal (F)

Size	Iu	Trip units	In	Type	3 poles	4 poles
					Code	Code
XT7	800	Ekip G Touch LSIG	800	XT7L 800 Ekip G Touch LSIG In=800A	1SDA103031R1	1SDA103253R1
	1000	Ekip G Touch LSIG	1000	XT7L 1000 Ekip G Touch LSIG In=1000A	1SDA103032R1	1SDA103254R1
	1200	Ekip G Touch LSIG	1200	XT7L 1200 Ekip G Touch LSIG In=1200A	1SDA103033R1	1SDA103255R1

SACE XT7L (100kA) Ekip G Hi-Touch LSIG - Front terminal (F)

Size	Iu	Trip units	In	Type	3 poles	4 poles
					Code	Code
XT7	800	Ekip G Hi-Touch LSIG	800	XT7L 800 Ekip G Hi-Touch LSIG In=800A	1SDA103034R1	1SDA103256R1
	1000	Ekip G Hi-Touch LSIG	1000	XT7L 1000 Ekip G Hi-Touch LSIG In=1000A	1SDA103035R1	1SDA103257R1
	1200	Ekip G Hi-Touch LSIG	1200	XT7L 1200 Ekip G Hi-Touch LSIG In=1200A	1SDA103036R1	1SDA103258R1

Ordering codes for XT7/XT7 M

Automatic circuit-breakers – XT7 M



XT7 M - circuit-breaker

Distribution circuit-breaker

SACE XT7S M (50kA) Ekip Dip LS/I - Front terminal (F)

Size	lu	Trip units	In	Type	3 poles	4 poles
					Code	Code
XT7	800	Ekip Dip LS/I	800	XT7S M 800 Ekip Dip LS/I In=800A	1SDA103349R1	1SDA103581R1
	1000	Ekip Dip LS/I	1000	XT7S M 1000 Ekip Dip LS/I In=1000A	1SDA103350R1	1SDA103582R1
	1200	Ekip Dip LS/I	1200	XT7S M 1200 Ekip Dip LS/I In=1200A	1SDA103351R1	1SDA103583R1

SACE XT7S M (50kA) Ekip Dip LSI - Front terminal (F)

Size	lu	Trip units	In	Type	3 poles	4 poles
					Code	Code
XT7	800	Ekip Dip LSI	800	XT7S M 800 Ekip Dip LSI In=800A	1SDA103352R1	1SDA103584R1
	1000	Ekip Dip LSI	1000	XT7S M 1000 Ekip Dip LSI In=1000A	1SDA103353R1	1SDA103585R1
	1200	Ekip Dip LSI	1200	XT7S M 1200 Ekip Dip LSI In=1200A	1SDA103354R1	1SDA103586R1

SACE XT7S M (50kA) Ekip Dip LSIG - Front terminal (F)

Size	lu	Trip units	In	Type	3 poles	4 poles
					Code	Code
XT7	800	Ekip Dip LSIG	800	XT7S M 800 Ekip Dip LSIG In=800A	1SDA103355R1	1SDA103587R1
	1000	Ekip Dip LSIG	1000	XT7S M 1000 Ekip Dip LSIG In=1000A	1SDA103356R1	1SDA103588R1
	1200	Ekip Dip LSIG	1200	XT7S M 1200 Ekip Dip LSIG In=1200A	1SDA103357R1	1SDA103589R1

SACE XT7S M (50kA) Ekip Dip LIG - Front terminal (F)

Size	lu	Trip units	In	Type	3 poles	4 poles
					Code	Code
XT7	800	Ekip Dip LIG	800	XT7S M 800 Ekip Dip LIG In=800A	1SDA103391R1	1SDA103620R1
	1000	Ekip Dip LIG	1000	XT7S M 1000 Ekip Dip LIG In=1000A	1SDA103392R1	1SDA103621R1
	1200	Ekip Dip LIG	1200	XT7S M 1200 Ekip Dip LIG In=1200A	1SDA103393R1	1SDA103622R1

SACE XT7S M (50kA) Ekip Touch LSI - Front terminal (F)

Size	lu	Trip units	In	Type	3 poles	4 poles
					Code	Code
XT7	800	Ekip Touch LSI	800	XT7S M 800 Ekip Touch LSI In=800A	1SDA103358R1	1SDA103590R1
	1000	Ekip Touch LSI	1000	XT7S M 1000 Ekip Touch LSI In=1000A	1SDA103359R1	1SDA103591R1
	1200	Ekip Touch LSI	1200	XT7S M 1200 Ekip Touch LSI In=1200A	1SDA103360R1	1SDA103592R1



XT7 M - circuit-breaker

SACE XT7S M (50kA) Ekip Touch LSI - Front terminal (F)

Size	Iu	Trip units	In	Type	3 poles	4 poles
					Code	Code
XT7	800	Ekip Touch LSI	800	XT7S M 800 Ekip Touch LSI In=800A	1SDA103361R1	1SDA103593R1
	1000	Ekip Touch LSI	1000	XT7S M 1000 Ekip Touch LSI In=1000A	1SDA103362R1	1SDA103594R1
	1200	Ekip Touch LSI	1200	XT7S M 1200 Ekip Touch LSI In=1200A	1SDA103363R1	1SDA103595R1

SACE XT7S M (50kA) Ekip Touch Measuring LSI - Front terminal (F)

Size	Iu	Trip units	In	Type	3 poles	4 poles
					Code	Code
XT7	800	Ekip Touch Meas. LSI	800	XT7S M 800 Ekip Touch Meas. LSI In=800A	1SDA103364R1	1SDA103596R1
	1000	Ekip Touch Meas. LSI	1000	XT7S M 1000 Ekip Touch Meas. LSI In=1000A	1SDA103365R1	1SDA103597R1
	1200	Ekip Touch Meas. LSI	1200	XT7S M 1200 Ekip Touch Meas. LSI In=1200A	1SDA103366R1	1SDA103598R1

SACE XT7S M (50kA) Ekip Touch Measuring LSI - Front terminal (F)

Size	Iu	Trip units	In	Type	3 poles	4 poles
					Code	Code
XT7	800	Ekip Touch Meas. LSI	800	XT7S M 800 Ekip Touch Meas. LSI In=800A	1SDA103367R1	1SDA103599R1
	1000	Ekip Touch Meas. LSI	1000	XT7S M 1000 Ekip Touch Meas. LSI In=1000A	1SDA103368R1	1SDA103600R1
	1200	Ekip Touch Meas. LSI	1200	XT7S M 1200 Ekip Touch Meas. LSI In=1200A	1SDA103369R1	1SDA103601R1

SACE XT7S M (50kA) Ekip Hi-Touch LSI - Front terminal (F)

Size	Iu	Trip units	In	Type	3 poles	4 poles
					Code	Code
XT7	800	Ekip Hi-Touch LSI	800	XT7S M 800 Ekip Hi-Touch LSI In=800A	1SDA103370R1	1SDA103602R1
	1000	Ekip Hi-Touch LSI	1000	XT7S M 1000 Ekip Hi-Touch LSI In=1000A	1SDA103371R1	1SDA103603R1
	1200	Ekip Hi-Touch LSI	1200	XT7S M 1200 Ekip Hi-Touch LSI In=1200A	1SDA103372R1	1SDA103604R1

SACE XT7S M (50kA) Ekip Hi-Touch LSI - Front terminal (F)

Size	Iu	Trip units	In	Type	3 poles	4 poles
					Code	Code
XT7	800	Ekip Hi-Touch LSI	800	XT7S M 800 Ekip Hi-Touch LSI In=800A	1SDA103373R1	1SDA103605R1
	1000	Ekip Hi-Touch LSI	1000	XT7S M 1000 Ekip Hi-Touch LSI In=1000A	1SDA103374R1	1SDA103606R1
	1200	Ekip Hi-Touch LSI	1200	XT7S M 1200 Ekip Hi-Touch LSI In=1200A	1SDA103375R1	1SDA103607R1

Ordering codes for XT7/XT7 M

Automatic circuit-breakers – XT7 M



XT7 M - circuit-breaker

Motor protection circuit-breaker (MCP)

SACE XT7S M (50kA) Ekip M Dip I - Front terminal (F)

Size	Iu	Trip units	In	Type	3 poles	4 poles
					Code	Code
XT7	800	Ekip M Dip I	800	XT7S M 800 Ekip M Dip I In=800A	1SDA103376R1	#N/D
	1000	Ekip M Dip I	1000	XT7S M 1000 Ekip M Dip I In=1000A	1SDA103377R1	#N/D
	1200	Ekip M Dip I	1200	XT7S M 1200 Ekip M Dip I In=1200A	1SDA103378R1	#N/D

Motor protection circuit-breaker (MPCB)

SACE XT7S M (50kA) Ekip M Touch LRIU - Front terminal (F)

Size	Iu	Trip units	In	Type	3 poles	4 poles
					Code	Code
XT7	800	Ekip M Touch LRIU	800	XT7S M 800 Ekip M Touch LRIU In=800A	1SDA103379R1	#N/D
	1000	Ekip M Touch LRIU	1000	XT7S M 1000 Ekip M Touch LRIU In=1000A	1SDA103380R1	#N/D
	1200	Ekip M Touch LRIU	1200	XT7S M 1200 Ekip M Touch LRIU In=1200A	1SDA103381R1	#N/D

Generator protection circuit-breaker



XT7 M - circuit-breaker

SACE XT7S M (50kA) Ekip G Dip LS/I - Front terminal (F)

Size	Iu	Trip units	In	Type	3 poles	4 poles
					Code	Code
XT7	800	Ekip G Dip LS/I	800	XT7S M 800 Ekip G Dip LS/I In=800A	1SDA103382R1	1SDA103608R1
	1000	Ekip G Dip LS/I	1000	XT7S M 1000 Ekip G Dip LS/I In=1000A	1SDA103383R1	1SDA103609R1
	1200	Ekip G Dip LS/I	1200	XT7S M 1200 Ekip G Dip LS/I In=1200A	1SDA103384R1	1SDA103610R1

SACE XT7S M (50kA) Ekip G Touch LSIG - Front terminal (F)

Size	Iu	Trip units	In	Type	3 poles	4 poles
					Code	Code
XT7	800	Ekip G Touch LSIG	800	XT7S M 800 Ekip G Touch LSIG In=800A	1SDA101958R1	1SDA103611R1
	1000	Ekip G Touch LSIG	1000	XT7S M 1000 Ekip G Touch LSIG In=1000A	1SDA101959R1	1SDA103612R1
	1200	Ekip G Touch LSIG	1200	XT7S M 1200 Ekip G Touch LSIG In=1200A	1SDA101960R1	1SDA103613R1

SACE XT7S M (50kA) Ekip G Hi-Touch LSIG - Front terminal (F)

Size	Iu	Trip units	In	Type	3 poles	4 poles
					Code	Code
XT7	800	Ekip G Hi-Touch LSIG	800	XT7S M 800 Ekip G Hi-Touch LSIG In=800A	1SDA103385R1	1SDA103614R1
	1000	Ekip G Hi-Touch LSIG	1000	XT7S M 1000 Ekip G Hi-Touch LSIG In=1000A	1SDA103386R1	1SDA103615R1
	1200	Ekip G Hi-Touch LSIG	1200	XT7S M 1200 Ekip G Hi-Touch LSIG In=1200A	1SDA103387R1	1SDA103616R1

Ordering codes for XT7/XT7 M

Automatic circuit-breakers – XT7 M



XT7 M - circuit-breaker

Distribution circuit-breaker

SACE XT7H M (65kA) Ekip Dip LS/I - Front terminal (F)

Size	lu	Trip units	In	Type	3 poles	4 poles
					Code	Code
XT7	800	Ekip Dip LS/I	800	XT7H M 800 Ekip Dip LS/I In=800A	1SDA103394R1	1SDA103623R1
	1000	Ekip Dip LS/I	1000	XT7H M 1000 Ekip Dip LS/I In=1000A	1SDA103395R1	1SDA103624R1
	1200	Ekip Dip LS/I	1200	XT7H M 1200 Ekip Dip LS/I In=1200A	1SDA103396R1	1SDA103625R1

SACE XT7H M (65kA) Ekip Dip LSI - Front terminal (F)

Size	lu	Trip units	In	Type	3 poles	4 poles
					Code	Code
XT7	800	Ekip Dip LSI	800	XT7H M 800 Ekip Dip LSI In=800A	1SDA103397R1	1SDA103626R1
	1000	Ekip Dip LSI	1000	XT7H M 1000 Ekip Dip LSI In=1000A	1SDA103398R1	1SDA103627R1
	1200	Ekip Dip LSI	1200	XT7H M 1200 Ekip Dip LSI In=1200A	1SDA103399R1	1SDA103628R1

SACE XT7H M (65kA) Ekip Dip LSIG - Front terminal (F)

Size	lu	Trip units	In	Type	3 poles	4 poles
					Code	Code
XT7	800	Ekip Dip LSIG	800	XT7H M 800 Ekip Dip LSIG In=800A	1SDA103400R1	1SDA103629R1
	1000	Ekip Dip LSIG	1000	XT7H M 1000 Ekip Dip LSIG In=1000A	1SDA103401R1	1SDA103630R1
	1200	Ekip Dip LSIG	1200	XT7H M 1200 Ekip Dip LSIG In=1200A	1SDA103402R1	1SDA103631R1

SACE XT7H M (65kA) Ekip Dip LIG - Front terminal (F)

Size	lu	Trip units	In	Type	3 poles	4 poles
					Code	Code
XT7	800	Ekip Dip LIG	800	XT7H M 800 Ekip Dip LIG In=800A	1SDA103436R1	1SDA103662R1
	1000	Ekip Dip LIG	1000	XT7H M 1000 Ekip Dip LIG In=1000A	1SDA103437R1	1SDA103663R1
	1200	Ekip Dip LIG	1200	XT7H M 1200 Ekip Dip LIG In=1200A	1SDA103438R1	1SDA103664R1

SACE XT7H M (65kA) Ekip Touch LSI - Front terminal (F)

Size	lu	Trip units	In	Type	3 poles	4 poles
					Code	Code
XT7	800	Ekip Touch LSI	800	XT7H M 800 Ekip Touch LSI In=800A	1SDA103403R1	1SDA103632R1
	1000	Ekip Touch LSI	1000	XT7H M 1000 Ekip Touch LSI In=1000A	1SDA103404R1	1SDA103633R1
	1200	Ekip Touch LSI	1200	XT7H M 1200 Ekip Touch LSI In=1200A	1SDA103405R1	1SDA103634R1



XT7 M - circuit-breaker

SACE XT7H M (65kA) Ekip Touch LSI - Front terminal (F)

Size	Iu	Trip units	In	Type	3 poles	4 poles
					Code	Code
XT7	800	Ekip Touch LSI	800	XT7H M 800 Ekip Touch LSI In=800A	1SDA103406R1	1SDA103635R1
	1000	Ekip Touch LSI	1000	XT7H M 1000 Ekip Touch LSI In=1000A	1SDA103407R1	1SDA103636R1
	1200	Ekip Touch LSI	1200	XT7H M 1200 Ekip Touch LSI In=1200A	1SDA103408R1	1SDA103637R1

SACE XT7H M (65kA) Ekip Touch Measuring LSI - Front terminal (F)

Size	Iu	Trip units	In	Type	3 poles	4 poles
					Code	Code
XT7	800	Ekip Touch Meas. LSI	800	XT7H M 800 Ekip Touch Meas. LSI In=800A	1SDA103409R1	1SDA103638R1
	1000	Ekip Touch Meas. LSI	1000	XT7H M 1000 Ekip Touch Meas. LSI In=1000A	1SDA103410R1	1SDA103639R1
	1200	Ekip Touch Meas. LSI	1200	XT7H M 1200 Ekip Touch Meas. LSI In=1200A	1SDA103411R1	1SDA103640R1

SACE XT7H M (65kA) Ekip Touch Measuring LSI - Front terminal (F)

Size	Iu	Trip units	In	Type	3 poles	4 poles
					Code	Code
XT7	800	Ekip Touch Meas. LSI	800	XT7H M 800 Ekip Touch Meas. LSI In=800A	1SDA103412R1	1SDA103641R1
	1000	Ekip Touch Meas. LSI	1000	XT7H M 1000 Ekip Touch Meas. LSI In=1000A	1SDA103413R1	1SDA103642R1
	1200	Ekip Touch Meas. LSI	1200	XT7H M 1200 Ekip Touch Meas. LSI In=1200A	1SDA103414R1	1SDA103643R1

SACE XT7H M (65kA) Ekip Hi-Touch LSI - Front terminal (F)

Size	Iu	Trip units	In	Type	3 poles	4 poles
					Code	Code
XT7	800	Ekip Hi-Touch LSI	800	XT7H M 800 Ekip Hi-Touch LSI In=800A	1SDA103415R1	1SDA103644R1
	1000	Ekip Hi-Touch LSI	1000	XT7H M 1000 Ekip Hi-Touch LSI In=1000A	1SDA103416R1	1SDA103645R1
	1200	Ekip Hi-Touch LSI	1200	XT7H M 1200 Ekip Hi-Touch LSI In=1200A	1SDA103417R1	1SDA103646R1

SACE XT7H M (65kA) Ekip Hi-Touch LSI - Front terminal (F)

Size	Iu	Trip units	In	Type	3 poles	4 poles
					Code	Code
XT7	800	Ekip Hi-Touch LSI	800	XT7H M 800 Ekip Hi-Touch LSI In=800A	1SDA103418R1	1SDA103647R1
	1000	Ekip Hi-Touch LSI	1000	XT7H M 1000 Ekip Hi-Touch LSI In=1000A	1SDA103419R1	1SDA103648R1
	1200	Ekip Hi-Touch LSI	1200	XT7H M 1200 Ekip Hi-Touch LSI In=1200A	1SDA103420R1	1SDA103649R1

Ordering codes for XT7/XT7 M

Automatic circuit-breakers – XT7 M



XT7 M - circuit-breaker

Motor protection circuit-breaker (MCP)

SACE XT7H M (65kA) Ekip M Dip I - Front terminal (F)

Size	Iu	Trip units	In	Type	3 poles	4 poles
					Code	Code
XT7	800	Ekip M Dip I	800	XT7H M 800 Ekip M Dip I In=800A	1SDA103421R1	
	1000	Ekip M Dip I	1000	XT7H M 1000 Ekip M Dip I In=1000A	1SDA103422R1	
	1200	Ekip M Dip I	1200	XT7H M 1200 Ekip M Dip I In=1200A	1SDA103423R1	

Motor protection circuit-breaker (MPCB)

SACE XT7H M (65kA) Ekip M Touch LRIU - Front terminal (F)

Size	Iu	Trip units	In	Type	3 poles	4 poles
					Code	Code
XT7	800	Ekip M Touch LRIU	800	XT7H M 800 Ekip M Touch LRIU In=800A	1SDA103424R1	
	1000	Ekip M Touch LRIU	1000	XT7H M 1000 Ekip M Touch LRIU In=1000A	1SDA103425R1	
	1200	Ekip M Touch LRIU	1200	XT7H M 1200 Ekip M Touch LRIU In=1200A	1SDA103426R1	

Generator protection circuit-breaker



XT7 M - circuit-breaker

SACE XT7H M (65kA) Ekip G Dip LS/I - Front terminal (F)

Size	Iu	Trip units	In	Type	3 poles	4 poles
					Code	Code
XT7	800	Ekip G Dip LS/I	800	XT7H M 800 Ekip G Dip LS/I In=800A	1SDA103427R1	1SDA103650R1
	1000	Ekip G Dip LS/I	1000	XT7H M 1000 Ekip G Dip LS/I In=1000A	1SDA103428R1	1SDA103651R1
	1200	Ekip G Dip LS/I	1200	XT7H M 1200 Ekip G Dip LS/I In=1200A	1SDA103429R1	1SDA103652R1

SACE XT7H M (65kA) Ekip G Touch LSIG - Front terminal (F)

Size	Iu	Trip units	In	Type	3 poles	4 poles
					Code	Code
XT7	800	Ekip G Touch LSIG	800	XT7H M 800 Ekip G Touch LSIG In=800A	1SDA101961R1	1SDA103653R1
	1000	Ekip G Touch LSIG	1000	XT7H M 1000 Ekip G Touch LSIG In=1000A	1SDA101962R1	1SDA103654R1
	1200	Ekip G Touch LSIG	1200	XT7H M 1200 Ekip G Touch LSIG In=1200A	1SDA101963R1	1SDA103655R1

SACE XT7H M (65kA) Ekip G Hi-Touch LSIG - Front terminal (F)

Size	Iu	Trip units	In	Type	3 poles	4 poles
					Code	Code
XT7	800	Ekip G Hi-Touch LSIG	800	XT7H M 800 Ekip G Hi-Touch LSIG In=800A	1SDA103430R1	1SDA103656R1
	1000	Ekip G Hi-Touch LSIG	1000	XT7H M 1000 Ekip G Hi-Touch LSIG In=1000A	1SDA103431R1	1SDA103657R1
	1200	Ekip G Hi-Touch LSIG	1200	XT7H M 1200 Ekip G Hi-Touch LSIG In=1200A	1SDA103432R1	1SDA103658R1

Ordering codes for XT7/XT7 M

Automatic circuit-breakers – XT7 M



XT7 M - circuit-breaker

Distribution circuit-breaker

SACE XT7L M (100kA) Ekip Dip LS/I - Front terminal (F)

Size	lu	Trip units	In	Type	3 poles	4 poles
					Code	Code
XT7	800	Ekip Dip LS/I	800	XT7L M 800 Ekip Dip LS/I In=800A	1SDA103439R1	1SDA103665R1
	1000	Ekip Dip LS/I	1000	XT7L M 1000 Ekip Dip LS/I In=1000A	1SDA103440R1	1SDA103666R1
	1200	Ekip Dip LS/I	1200	XT7L M 1200 Ekip Dip LS/I In=1200A	1SDA103441R1	1SDA103667R1

SACE XT7L M (100kA) Ekip Dip LSI - Front terminal (F)

Size	lu	Trip units	In	Type	3 poles	4 poles
					Code	Code
XT7	800	Ekip Dip LSI	800	XT7L M 800 Ekip Dip LSI In=800A	1SDA103442R1	1SDA103668R1
	1000	Ekip Dip LSI	1000	XT7L M 1000 Ekip Dip LSI In=1000A	1SDA103443R1	1SDA103669R1
	1200	Ekip Dip LSI	1200	XT7L M 1200 Ekip Dip LSI In=1200A	1SDA103444R1	1SDA103670R1

SACE XT7L M (100kA) Ekip Dip LSIG - Front terminal (F)

Size	lu	Trip units	In	Type	3 poles	4 poles
					Code	Code
XT7	800	Ekip Dip LSIG	800	XT7L M 800 Ekip Dip LSIG In=800A	1SDA103445R1	1SDA103671R1
	1000	Ekip Dip LSIG	1000	XT7L M 1000 Ekip Dip LSIG In=1000A	1SDA103446R1	1SDA103672R1
	1200	Ekip Dip LSIG	1200	XT7L M 1200 Ekip Dip LSIG In=1200A	1SDA103447R1	1SDA103673R1

SACE XT7L M (100kA) Ekip Dip LIG - Front terminal (F)

Size	lu	Trip units	In	Type	3 poles	4 poles
					Code	Code
XT7	800	Ekip Dip LIG	800	XT7L M 800 Ekip Dip LIG In=800A	1SDA103484R1	1SDA103704R1
	1000	Ekip Dip LIG	1000	XT7L M 1000 Ekip Dip LIG In=1000A	1SDA103485R1	1SDA103705R1
	1200	Ekip Dip LIG	1200	XT7L M 1200 Ekip Dip LIG In=1200A	1SDA103486R1	1SDA103706R1

SACE XT7L M (100kA) Ekip Touch LSI - Front terminal (F)

Size	lu	Trip units	In	Type	3 poles	4 poles
					Code	Code
XT7	800	Ekip Touch LSI	800	XT7L M 800 Ekip Touch LSI In=800A	1SDA103448R1	1SDA103674R1
	1000	Ekip Touch LSI	1000	XT7L M 1000 Ekip Touch LSI In=1000A	1SDA103449R1	1SDA103675R1
	1200	Ekip Touch LSI	1200	XT7L M 1200 Ekip Touch LSI In=1200A	1SDA103450R1	1SDA103676R1



XT7 M - circuit-breaker

SACE XT7L M (100kA) Ekip Touch LSI - Front terminal (F)

Size	Iu	Trip units	In	Type	3 poles	4 poles
					Code	Code
XT7	800	Ekip Touch LSI	800	XT7L M 800 Ekip Touch LSI In=800A	1SDA103451R1	1SDA103677R1
	1000	Ekip Touch LSI	1000	XT7L M 1000 Ekip Touch LSI In=1000A	1SDA103452R1	1SDA103678R1
	1200	Ekip Touch LSI	1200	XT7L M 1200 Ekip Touch LSI In=1200A	1SDA103453R1	1SDA103679R1

SACE XT7L M (100kA) Ekip Touch Measuring LSI - Front terminal (F)

Size	Iu	Trip units	In	Type	3 poles	4 poles
					Code	Code
XT7	800	Ekip Touch Meas. LSI	800	XT7L M 800 Ekip Touch Meas. LSI In=800A	1SDA103454R1	1SDA103680R1
	1000	Ekip Touch Meas. LSI	1000	XT7L M 1000 Ekip Touch Meas. LSI In=1000A	1SDA103455R1	1SDA103681R1
	1200	Ekip Touch Meas. LSI	1200	XT7L M 1200 Ekip Touch Meas. LSI In=1200A	1SDA103456R1	1SDA103682R1

SACE XT7L M (100kA) Ekip Touch Measuring LSI - Front terminal (F)

Size	Iu	Trip units	In	Type	3 poles	4 poles
					Code	Code
XT7	800	Ekip Touch Meas. LSI	800	XT7L M 800 Ekip Touch Meas. LSI In=800A	1SDA103457R1	1SDA103683R1
	1000	Ekip Touch Meas. LSI	1000	XT7L M 1000 Ekip Touch Meas. LSI In=1000A	1SDA103458R1	1SDA103684R1
	1200	Ekip Touch Meas. LSI	1200	XT7L M 1200 Ekip Touch Meas. LSI In=1200A	1SDA103459R1	1SDA103685R1

SACE XT7L M (100kA) Ekip Hi-Touch LSI - Front terminal (F)

Size	Iu	Trip units	In	Type	3 poles	4 poles
					Code	Code
XT7	800	Ekip Hi-Touch LSI	800	XT7L M 800 Ekip Hi-Touch LSI In=800A	1SDA103460R1	1SDA103686R1
	1000	Ekip Hi-Touch LSI	1000	XT7L M 1000 Ekip Hi-Touch LSI In=1000A	1SDA103461R1	1SDA103687R1
	1200	Ekip Hi-Touch LSI	1200	XT7L M 1200 Ekip Hi-Touch LSI In=1200A	1SDA103462R1	1SDA103688R1

SACE XT7L M (100kA) Ekip Hi-Touch LSI - Front terminal (F)

Size	Iu	Trip units	In	Type	3 poles	4 poles
					Code	Code
XT7	800	Ekip Hi-Touch LSI	800	XT7L M 800 Ekip Hi-Touch LSI In=800A	1SDA103463R1	1SDA103689R1
	1000	Ekip Hi-Touch LSI	1000	XT7L M 1000 Ekip Hi-Touch LSI In=1000A	1SDA103464R1	1SDA103690R1
	1200	Ekip Hi-Touch LSI	1200	XT7L M 1200 Ekip Hi-Touch LSI In=1200A	1SDA103465R1	1SDA103691R1

Ordering codes for XT7/XT7 M

Automatic circuit-breakers – XT7 M



XT7 M - circuit-breaker

Motor protection circuit-breaker (MCP)

SACE XT7L M (100kA) Ekip M Dip I - Front terminal (F)

Size	Iu	Trip units	In	Type	3 poles	4 poles
					Code	Code
XT7	800	Ekip M Dip I	800	XT7L M 800 Ekip M Dip I In=800A	1SDA103466R1	
	1000	Ekip M Dip I	1000	XT7L M 1000 Ekip M Dip I In=1000A	1SDA103467R1	
	1200	Ekip M Dip I	1200	XT7L M 1200 Ekip M Dip I In=1200A	1SDA103468R1	

Motor protection circuit-breaker (MPCB)

SACE XT7L M (100kA) Ekip M Touch LRIU - Front terminal (F)

Size	Iu	Trip units	In	Type	3 poles	4 poles
					Code	Code
XT7	800	Ekip M Touch LRIU	800	XT7L M 800 Ekip M Touch LRIU In=800A	1SDA103469R1	
	1000	Ekip M Touch LRIU	1000	XT7L M 1000 Ekip M Touch LRIU In=1000A	1SDA103470R1	
	1200	Ekip M Touch LRIU	1200	XT7L M 1200 Ekip M Touch LRIU In=1200A	1SDA103471R1	

Generator protection circuit-breaker



XT7 M - circuit-breaker

SACE XT7L M (100kA) Ekip G Dip LS/I - Front terminal (F)

Size	Iu	Trip units	In	Type	3 poles	4 poles
					Code	Code
XT7	800	Ekip G Dip LS/I	800	XT7L M 800 Ekip G Dip LS/I In=800A	1SDA103472R1	1SDA103692R1
	1000	Ekip G Dip LS/I	1000	XT7L M 1000 Ekip G Dip LS/I In=1000A	1SDA103473R1	1SDA103693R1
	1200	Ekip G Dip LS/I	1200	XT7L M 1200 Ekip G Dip LS/I In=1200A	1SDA103474R1	1SDA103694R1

SACE XT7L M (100kA) Ekip G Touch LSIG - Front terminal (F)

Size	Iu	Trip units	In	Type	3 poles	4 poles
					Code	Code
XT7	800	Ekip G Touch LSIG	800	XT7L M 800 Ekip G Touch LSIG In=800A	1SDA103475R1	1SDA103695R1
	1000	Ekip G Touch LSIG	1000	XT7L M 1000 Ekip G Touch LSIG In=1000A	1SDA103476R1	1SDA103696R1
	1200	Ekip G Touch LSIG	1200	XT7L M 1200 Ekip G Touch LSIG In=1200A	1SDA103477R1	1SDA103697R1

SACE XT7L M (100kA) Ekip G Hi-Touch LSIG - Front terminal (F)

Size	Iu	Trip units	In	Type	3 poles	4 poles
					Code	Code
XT7	800	Ekip G Hi-Touch LSIG	800	XT7L M 800 Ekip G Hi-Touch LSIG In=800A	1SDA103478R1	1SDA103698R1
	1000	Ekip G Hi-Touch LSIG	1000	XT7L M 1000 Ekip G Hi-Touch LSIG In=1000A	1SDA103479R1	1SDA103699R1
	1200	Ekip G Hi-Touch LSIG	1200	XT7L M 1200 Ekip G Hi-Touch LSIG In=1200A	1SDA103480R1	1SDA103700R1

Ordering codes for XT7/XT7 M

Automatic circuit-breakers

Molded case switches

SACE XT7D/XT7D M - MCS

Size	lu	Type	3 poles	4 poles
			Code	Code
XT7	1000	XT7S-D 1000	1SDA103791R1	1SDA103797R1
		XT7H-D 1000	1SDA103793R1	1SDA103799R1
		XT7L-D 1000	1SDA103795R1	1SDA103801R1
	1200	XT7S-D 1200	1SDA103792R1	1SDA103798R1
		XT7H-D 1200	1SDA103794R1	1SDA103800R1
		XT7L-D 1200	1SDA103796R1	1SDA103802R1
XT7 M	1000	XT7S-D M 1000	1SDA103803R1	1SDA103809R1
		XT7H-D M 1000	1SDA103805R1	1SDA103811R1
		XT7L-D M 1000	1SDA103807R1	1SDA103813R1
	1200	XT7S-D M 1200	1SDA103804R1	1SDA103810R1
		XT7H-D M 1200	1SDA103806R1	1SDA103812R1
		XT7L-D M 1200	1SDA103808R1	1SDA103814R1

100% rated distribution circuit-breakers

100% rated version extra code

Size	3 poles	4 poles
	Code	Code
XT7	1SDA107723R1	1SDA107724R1
XT7 M	1SDA107725R1	1SDA107726R1

Note: to be specified only in addition to the code of the automatic circuit-breaker

Ordering codes for XT7/XT7 M

Trip units – XT7/XT7 M

Trip Units - BASIC*



Ekip Dip Trip unit

Trip units - Distribution protection

Size	Type	3/4 poles
		Code
XT7/XT7 M	Ekip Dip LS/I	1SDA101918R1
	Ekip Dip LIG	1SDA101933R1

Trip units - Generator protection

Size	Type	3/4 poles
		Code
XT7/XTM	Ekip G Dip LS/I	1SDA101929R1

Trip Units - OTHERS*



Ekip Dip Trip unit



Ekip Touch Trip unit

Trip units - Distribution protection

Size	Type	3/4 poles
		Code
XT7/XT7 M	Ekip Dip LSI	1SDA101919R1
	Ekip Dip LSIG	1SDA101920R1
	Ekip Touch LSI	1SDA101921R1
	Ekip Touch LSIG	1SDA101922R1
	Ekip Touch Measuring LSI	1SDA101923R1
	Ekip Touch Measuring LSIG	1SDA101924R1
	Ekip Hi-Touch LSI	1SDA101925R1
	Ekip Hi-Touch LSIG	1SDA101926R1

Trip units - Generator protection

Size	Type	3/4 poles
		Code
XT7/XTM	Ekip G Touch LSIG	1SDA101930R1
	Ekip G Hi-Touch LSIG	1SDA101931R1

* All the trip units can be interchanged only if are part of the same family: BASIC trip unit can not be upgraded with the others, the others can not be replaced with the basic. Dedicated rating plug are available (see table pag.8/107)

Ordering codes for accessories

Execution and installation

Fixed parts



Fixed part of plug-in circuit-breaker

Fixed part of plug-in (P) circuit-breaker

Size	Type	3 poles	4 poles
XT1	P FP EF	1SDA068183R1	1SDA068185R1
XT1	P FP HR/VR ⁽¹⁾	1SDA068184R1	1SDA068186R1
XT2	P FP EF	1SDA068187R1	1SDA068190R1
XT2	P FP HR/VR ⁽¹⁾⁽²⁾	1SDA068189R1	1SDA068191R1
XT3	P FP EF	1SDA068192R1	1SDA068194R1
XT3	P FP HR/VR ⁽¹⁾	1SDA068193R1	1SDA068195R1
XT4	P FP EF	1SDA068196R1	1SDA068198R1
XT4	P FP HR/VR ⁽¹⁾⁽²⁾	1SDA068197R1	1SDA068199R1
XT5	P FP 400A EF	1SDA104669R1	1SDA104673R1
XT5	P FP 400A HR/HR	1SDA104671R1	1SDA104675R1
XT5	P FP 400A VR/VR	1SDA112962R1	1SDA112964R1
XT5	P FP 630A EF	1SDA104676R1	1SDA104679R1
XT5	P FP 630A HR	1SDA104677R1	1SDA104680R1
XT5	P FP 630A VR	1SDA104678R1	1SDA104681R1

(1) The terminals are factory-mounted in the horizontal position (HR)

(2) Not UL listed

Fixed part of plug-in (P) frame configurable

Size	Type	3 poles	4 poles
XT5	P FP 400A frame configurable	1SDA112953R1	1SDA112954R1
XT5	P FP 630A frame configurable	1SDA112955R1	1SDA112956R1

Fixed part of withdrawable (W) circuit-breaker

Size	Type	3 poles	4 poles
XT2	W FP EF	1SDA068200R1	1SDA068202R1
XT2	W FP HR/VR ⁽¹⁾⁽²⁾	1SDA068201R1	1SDA068203R1
XT4	W FP EF	1SDA068204R1	1SDA068206R1
XT4	W FP HR/VR ⁽¹⁾⁽²⁾	1SDA068205R1	1SDA068207R1
XT5	W FP 400A EF	1SDA104683R1	1SDA104687R1
XT5	W FP 400A HR/HR	1SDA104685R1	1SDA104689R1
XT5	W FP 400A VR/VR	1SDA112966R1	1SDA112968R1
XT5	W FP 630A EF	1SDA104690R1	1SDA104693R1
XT5	W FP 630A HR	1SDA104691R1	1SDA104694R1
XT5	W FP 630A VR	1SDA104692R1	1SDA104695R1
XT6	W FP EF	1SDA104696R1	1SDA104699R1
XT6	W FP HR	1SDA104697R1	1SDA104700R1
XT6	W FP VR	1SDA104698R1	1SDA104701R1
XT7-XT7 M	W FP EF	1SDA104702R1	1SDA104704R1
XT7-XT7 M	W FP HR	1SDA104703R1	1SDA104705R1

(1) The terminals are factory-mounted in the horizontal position (HR)

(2) Not UL listed



Fixed part of withdrawable circuit-breaker



Fixed part of withdrawable XT7-XT7 M

Fixed part of withdrawable (W) frame configurable

Size	Type	3 poles	4 poles
XT5	W FP 400A frame configurable	1SDA112957R1	1SDA112958R1
XT5	W FP 630A frame configurable	1SDA112959R1	1SDA112960R1
XT6	W FP XT6 frame configurable	1SDA112969R1	1SDA112970R1

Conversion kits**Conversion kit to convert circuit-breaker from fixed to moving part of a plug-in unit**

Size	Type	3 poles	4 poles
XT1	P MP Kit	1SDA066276R1	1SDA066277R1
XT2	P MP Kit	1SDA066278R1	1SDA066279R1
XT3	P MP Kit	1SDA066280R1	1SDA066281R1
XT4	P MP Kit	1SDA066282R1	1SDA066283R1
XT5	P MP Kit 400A	1SDA104707R1	1SDA104708R1
XT5	P MP Kit 630A	1SDA104709R1	1SDA104710R1

Conversion kit to convert circuit-breaker from fixed to moving part of a withdrawable unit

Size	Type	3 poles	4 poles
XT2	W MP Kit	1SDA066284R1	1SDA066285R1
XT4	W MP Kit	1SDA066286R1	1SDA066287R1
XT5	W MP Kit 400A	1SDA104711R1	1SDA104712R1
XT5	W MP Kit 630A	1SDA104713R1	1SDA104714R1
XT6	W MP Kit	1SDA104715R1	1SDA104716R1
XT7-XT7 M	W MP Kit	1SDA104717R1	1SDA104718R1

Conversion kit to convert circuit-breaker fixed part from plug-in to a withdrawable unit

Size	Type	Code
XT2	XT2 FP P>W Kit	1SDA066288R1
XT4	XT4 FP P>W Kit	1SDA066289R1
XT5	XT5 FP P>W Kit	1SDA104706R1

Conversion kit to convert an RC from fixed to a plug-in unit

Size	Type	Code
XT2	XT2 P MP RC Sel 4p Kit	1SDA066290R1
XT4	XT4 P MP RC Sel 4p Kit	1SDA066291R1
XT5	XT5 400A P MP RC Sel 4p Kit	1SDA104719R1
XT5	XT5 630A P MP RC Sel 4p Kit	1SDA104720R1

Conversion kit to convert an RC from a plug-in into a withdrawable unit

Size	Type	Code
XT2	XT2 W MP RC Sel 4p Kit	1SDA066292R1
XT4	XT4 W MP RC Sel 4p Kit	1SDA067115R1
XT5	XT5 400A W MP RC Sel 4p Kit	1SDA104721R1
XT5	XT5 630A W MP RC Sel 4p Kit	1SDA104722R1



—
Conversion kit for turning a fixed circuit-breaker into the moving part of a plug-in circuit-breaker



—
Conversion kit for turning a fixed circuit-breaker into the moving part of a withdrawable circuit-breaker



—
Conversion kit for turning a fixed part of plug-in version into a fixed part of withdrawable version circuit-breaker

Ordering codes for accessories

Execution and installation

Plug and socket adapters

Socket plug connector on rear of the panel



Fixed part socket-plug connector

Size	Type	Code
XT1...XT6	Socket-plug panel connector with 3PINS	1SDA066409R1
XT1...XT6	Socket-plug panel connector with 6PINS	1SDA066410R1
XT1...XT6	Socket-plug panel connector with 9PINS	1SDA066411R1
XT1...XT6	Socket-plug panel connector with 15PINS	1SDA066412R1

Fixed part socket-plug connector



Socket-plug panel connector

Size	Type	Code
XT2-XT4-XT5-XT6	Socket-plug connector for Moving Part 12PINS	1SDA066413R1
XT2-XT4-XT5-XT6	Socket-plug connector for Fixed Part 12PINS	1SDA066414R1

Bracket for fixing on DIN-rail

Bracket for fixing onto DIN-rail



DIN guide

Size	Type	3 poles	4 poles
XT1	KIT DIN50022	1SDA066652R1	1SDA066419R1
XT1	KIT DIN50022 + RC Low 200mm		1SDA067134R1
XT1	KIT DIN50022 +RC Sel/RC Inst	1SDA067135R1	1SDA067135R1
XT2	KIT DIN50022	1SDA080704R1	1SDA080325R1
XT3	KIT DIN50022	1SDA066420R1	1SDA066421R1
XT3	KIT DIN50022 + RC Inst / RC Sel	1SDA067139R1	1SDA067139R1
XT4	KIT DIN50022	1SDA080326R1	1SDA080327R1

Floor fixing plate

Floor fixing plate

Size	Type	Code
XT7-XT7 M	Floor fixing plate for fixed unit	1SDA076020R1

Cable rack

Cable rack

Size	Type	Code
XT5-XT6	Cable rack for fixed and plug-in circuit breaker	1SDA104729R1

Ordering codes for accessories

Power connection

Terminals for circuit-breaker

Terminals for circuit-breaker

Size	Type	3 pcs (1/2 kit for 3p)	4 pcs (1/2 kit for 4p)
XT1	F Front terminals	1SDA066849R1	1SDA066850R1
XT1	F Front terminals MCP	1SDA076601R1	1SDA076602R1
XT1	EF Extended front terminals	1SDA066865R1	1SDA066866R1
XT1	ES Extended spread front terminals	1SDA066889R1	1SDA066890R1
XT1	FC Cu terminal for Cu cables 14-1/0 AWG ⁽¹⁾	1SDA075869R1	1SDA075870R1
XT1	FC Cu terminal for Cu cables 14-1/0 AWG	1SDA075873R1	
XT1	FC CuAl terminals for CuAl cables 10-2/0 AWG	1SDA075837R1	1SDA075838R1
XT1	FC CuAl terminals AuxV for CuAl cables 10-2/0 AWG	1SDA085583R1	1SDA085584R1
XT1	MC Cu multi-cable terminal for Cu cables 6x14-2 AWG	1SDA075897R1	1SDA075898R1
XT1	R rear Adjustable terminal ⁽¹⁾	1SDA066937R1	1SDA066938R1
XT1	R-RC Rear terminals for residual current		1SDA066953R1
XT1	FB Flexible busbar terminals	1SDA066957R1	1SDA066958R1
XT2	F Front terminals	1SDA066853R1	1SDA066854R1
XT2	EF Extended front terminals	1SDA066869R1	1SDA066870R1
XT2	ES Extended spread front terminals	1SDA066893R1	1SDA066894R1
XT2	FC CuAl terminals for CuAl cables 14-1/0 AWG	1SDA075841R1	1SDA075842R1
XT2	FC CuAl terminals for CuAl cables 10-2/0 AWG	1SDA085585R1	1SDA085586R1
XT2	FC CuAl terminals AuxV for CuAl cables 10-2/0 AWG	1SDA085589R1	1SDA085590R1
XT2	FC Cu terminals for Cu cables 14-1/0 AWG	1SDA075881R1	1SDA075882R1
XT2	MC Cu multi-cable terminals for Cu cables 6x14-2 AWG	1SDA075901R1	1SDA075902R1
XT2	R Rear adjustable terminals	1SDA066941R1	1SDA066942R1
XT2	FB Flexible busbar terminals	1SDA066961R1	1SDA066962R1
XT3	F Front terminals	1SDA066857R1	1SDA066858R1
XT3	EF Extended front terminals	1SDA066873R1	1SDA066874R1
XT3	ES Extended spread front terminals	1SDA066897R1	1SDA066898R1
XT3	FC CuAl terminals AuxV for CuAl cables 14-1/0 AWG	1SDA081990R1	1SDA081991R1
XT3	FC CuAl terminals for CuAl cables 14-1/0 AWG	1SDA075849R1	1SDA075850R1
XT3	FC CuAl terminals AuxV for CuAl cables 4 AWG-300 Kcmil	1SDA081988R1	1SDA081989R1
XT3	FC CuAl terminals for CuAl cables 4 AWG-300 Kcmil	1SDA075853R1	1SDA075854R1
XT3	FC Cu terminals for Cu cables 10-250 AWG	1SDA075885R1	1SDA075886R1
XT3	MC Cu multi-cable terminals for Cu cables 6x12-2 AWG	1SDA075905R1	1SDA075906R1
XT3	R Rear adjustable terminals	1SDA066945R1	1SDA066946R1
XT3	FB Flexible busbar terminals	1SDA066965R1	1SDA066966R1
XT3	R-RC Rear terminal for RC Inst-Sel		1SDA066954R1

(1) Not suitable for MA trip units



— Front extended terminal - EF



— Front extended spread terminal - ES



— FCCu terminal



— FCCuAl external terminal



— FCCuAl internal terminal

Ordering codes for accessories

Power connection



— Multi-cable terminal (MC)



— Rear horizontal terminals (R)

Terminals for circuit-breaker

Size	Type	3 pcs (1/2 kit for 3p)	4 pcs (1/2 kit for 4p)
XT4	F Front terminals	1SDA066861R1	1SDA066862R1
XT4	EF Extended front terminals	1SDA066877R1	1SDA066878R1
XT4	ES Extended spread front terminals	1SDA066901R1	1SDA066902R1
XT4	FC CuAl terminals for CuAl cables 14-1/0 AWG	1SDA075857R1	1SDA075858R1
XT4	FC CuAl terminals AuxV for CuAl cables 14-1/0 AWG	1SDA081994R1	1SDA081995R1
XT4	FC CuAl terminals for CuAl cables 4 AWG-300 Kcmil	1SDA075861R1	1SDA075862R1
XT4	FC CuAl terminals AuxV for CuAl cables 4 AWG-300 Kcmil	1SDA081992R1	1SDA081993R1
XT4	FC CuAl terminals for CuAl cables 3/0 AWG-350 Kcmil ⁽¹⁾	1SDA075865R1	1SDA075866R1
XT4	FC CuAl terminals AuxV for CuAl cables 3/0 AWG-350 Kcmil ⁽¹⁾	1SDA085581R1	1SDA085582R1
XT4	FC Cu terminals for Cu cables 10-250 AWG	1SDA075893R1	1SDA075894R1
XT4	MC Cu multi-cable terminals for Cu cables 6x12-2 AWG	1SDA075909R1	1SDA075910R1
XT4	R Rear adjustable terminals	1SDA066949R1	1SDA066950R1
XT4	FB Flexible busbar terminals	1SDA066969R1	1SDA066970R1
XT5	F Front Terminals	1SDA104730R1	1SDA104731R1
XT5	EF Extended front terminals	1SDA104734R1	1SDA104735R1
XT5	ES Extended spread front terminals	1SDA104738R1	1SDA104739R1
XT5	FC CuAl 1x6AWG-350kcmi	1SDA113064R1	1SDA113065R1
XT5	FC CuAl 1x4/0-500kcmil	1SDA113062R1	1SDA113063R1
XT5	FC CuAl 2x2/0AWG-500kcmil	1SDA113066R1	1SDA113067R1
XT5	FC CuAl 1x500kcmil AuxV	1SDA113087R1	1SDA113088R1
XT5	FC CuAl 1x350kcmil AuxV	1SDA113089R1	1SDA113090R1
XT5	FC CuAl 2x500kcmil AuxV	1SDA113091R1	1SDA113092R1
XT5	R Rear adjustable Terminals	1SDA104760R1	1SDA104761R1
XT6	F Front Terminals	1SDA104732R1	1SDA104733R1
XT6	EF Extended front terminals	1SDA104736R1	1SDA104737R1
XT6	ES Extended spread front terminals Upper	1SDA104740R1	1SDA104741R1
XT6	ES Extended spread front terminals Lower	1SDA113127R1	1SDA104741R1
XT6	FC CuAl 2x250-500kcmil	1SDA113068R1	1SDA113069R1
XT6	FC CuAl 3x2/0AWG-400kcmil	1SDA113070R1	1SDA113071R1
XT6	FC CuAl 2x500kcmil AuxV	1SDA113093R1	1SDA113094R1
XT6	FC CuAl 3x400kcmil AuxV	1SDA113095R1	1SDA113096R1
XT6	R Rear adjustable Terminals	1SDA104762R1	1SDA104763R1

(1) External solution: lugs to be mounted on EF terminals supplied in the kit

Terminals loose supply for fixed circuit-breaker

Size	Type	3 pcs (1/2 kit for 3p)	4 pcs (1/2 kit for 4p)
XT7-XT7 M	F Front terminals	1SDA073973R1	1SDA073974R1
XT7-XT7 M	EF Extended front terminals	1SDA073967R1	1SDA073968R1
XT7-XT7 M	ES Extended spread front terminals Upper	1SDA073979R1	1SDA073980R1
XT7-XT7 M	ES Extended spread front terminals Lower	1SDA076076R1	1SDA073980R1
XT7-XT7 M	FC CuAl 4x4/0 AWG - 500 kcmil	1SDA104758R1	1SDA104759R1
XT7-XT7M	FC CuAl 3x500-750kcmil	1SDA113119R1	1SDA113120R1
XT7-XT7 M	HR/VR – Rear terminals	1SDA079844R1	1SDA079845R1

Terminals installed for fixed circuit-breaker

Size	Type	3 pcs (1/2 kit for 3p)	4 pcs (1/2 kit for 4p)
XT7-XT7 M	EF Extended front terminals Upper	1SDA073963R1	1SDA073964R1
XT7-XT7 M	EF Extended front terminals Lower	1SDA073965R1	1SDA073966R1
XT7-XT7 M	ES Extended spread front terminals Upper	1SDA073975R1	1SDA073976R1
XT7-XT7 M	ES Extended spread front terminals Lower	1SDA073977R1	1SDA073978R1
XT7-XT7 M	HR-Rear horizontal terminals Upper	1SDA073981R1	1SDA073982R1
XT7-XT7 M	HR-Rear horizontal terminals Lower	1SDA073983R1	1SDA073984R1
XT7-XT7 M	VR-Rear vertical terminals Upper	1SDA073985R1	1SDA073986R1
XT7-XT7 M	VR-Rear vertical terminals Lower	1SDA073987R1	1SDA073988R1
XT7-XT7 M	FC CuAl 4x4/0 AWG - 500kcmil Upper	1SDA073997R1	1SDA073998R1
XT7-XT7 M	FC CuAl 4x4/0 AWG - 500kcmil Lower	1SDA073999R1	1SDA074000R1
XT7-XT7M	FC CuAl 3x500-750kcmil Upper	1SDA113121R1	1SDA113122R1
XT7-XT7M	FC CuAl 3x500-750kcmil Lower	1SDA113123R1	1SDA113124R1

Ordering codes for accessories

Power connection

Terminals for fixed parts

Terminals for the fixed parts

Size	Type	3 pcs (1/2 kit for 3p)	4 pcs (1/2 kit for 4p)
XT1	EF – Front extended terminals	1SDA066260R1	1SDA066261R1
XT1	HR/VR – Rear terminals	1SDA066268R1	1SDA066269R1
XT2	EF – Front extended terminals	1SDA066262R1	1SDA066263R1
XT2	HR/VR – Rear terminals	1SDA066270R1	1SDA066271R1
XT3	EF – Front extended terminals	1SDA066264R1	1SDA066265R1
XT3	HR/VR – Rear terminals	1SDA066272R1	1SDA066273R1
XT4	EF – Front extended terminals	1SDA066266R1	1SDA066267R1
XT4	HR/VR – Rear terminals	1SDA066272R1	1SDA066273R1
XT5	EF – Front Extended Terminals 400A	1SDA107798R1	1SDA107799R1
XT5	HR/VR – Rear Terminals UL 400A	1SDA104776R1	1SDA104779R1
XT5	HR/VR – Rear Terminals (same length) 400A	1SDA104774R1	1SDA104777R1
XT5	EF – Front Extended Terminals 630A	1SDA104766R1	1SDA104767R1
XT5	HR – Rear Horizontal Terminals 630A	1SDA104770R1	1SDA104771R1
XT5	VR – Rear Vertical Terminals 630A	1SDA104780R1	1SDA104781R1
XT6	EF – Front Extended Terminals	1SDA104768R1	1SDA104769R1
XT6	HR – Rear Horizontal Terminals	1SDA104772R1	1SDA104773R1
XT6	VR – Rear Vertical Terminals	1SDA104782R1	1SDA104783R1



EF terminal for fixed part

Terminals loose supply for fixed parts

Size	Type	3 pcs (1/2 kit for 3p)	4 pcs (1/2 kit for 4p)
XT7-XT7 M	EF – Front extended terminals	1SDA073943R1	1SDA073944R1
XT7-XT7 M	ES – Front extended spread terminals	1SDA073955R1	1SDA073956R1
XT7-XT7 M	HR/VR – Rear terminals	1SDA107715R1	1SDA107716R1
XT7-XT7 M	SHR – Rear spread horizontal terminals	1SDA073961R1	1SDA073962R1
XT7-XT7 M	FC CuAl 4x4/0 AWG - 500 kcmil	1SDA073995R1	1SDA073996R1



HR terminals for fixed part

Terminals installed for fixed parts

Size	Type	3 pcs (1/2 kit for 3p)	4 pcs (1/2 kit for 4p)
XT7-XT7 M	EF Extended front terminals Upper	1SDA073939R1	1SDA073940R1
XT7-XT7 M	EF Extended front terminals Lower	1SDA073941R1	1SDA073942R1
XT7-XT7 M	ES Extended spread front terminals Upper	1SDA073951R1	1SDA073952R1
XT7-XT7 M	ES Extended spread front terminals Lower	1SDA073953R1	1SDA073954R1
XT7-XT7 M	SHR-Rear spread horizontal terminals Upper	1SDA073957R1	1SDA073958R1
XT7-XT7 M	SHR-Rear spread horizontal terminals Lower	1SDA073959R1	1SDA073960R1
XT7-XT7 M	FC CuAl 4x4/0 AWG - 500kcmil Upper	1SDA073991R1	1SDA073993R1
XT7-XT7 M	FC CuAl 4x4/0 AWG - 500kcmil Lower	1SDA073992R1	1SDA073994R1

Fixed part adapters



Fixed part adapter

Adapter for mounting the terminals of the fixed circuit-breaker on the fixed part

Size	Type	3 poles	4 poles
XT1	XT1 ADP adapter fixed part (2 pieces)	1SDA066305R1	1SDA066306R1
XT2	XT2 ADP adapter fixed part (2 pieces)	1SDA066307R1	1SDA066308R1
XT3	XT3 ADP adapter fixed part (2 pieces)	1SDA066309R1	1SDA066310R1
XT4	XT4 ADP adapter fixed part (2 pieces)	1SDA066311R1	1SDA066312R1
XT5	XT5 400A ADP adapter fixed part (2 pieces)	1SDA104723R1	1SDA104724R1
XT5	XT5 630A ADP adapter fixed part (2 pieces)	1SDA104725R1	1SDA104726R1
XT6	XT6 ADP adapter fixed part (2 pieces)	1SDA104727R1	1SDA104728R1

Note: when using an ADP with the F/EF/MC terminal, also order the "Kit F Front Terminals"

Ordering codes for accessories

Signaling

Auxiliary contacts - AUX



AUX uncabled

Auxiliary contacts - AUX

Size	Type	Fixed/Plug-in
Uncabled version		
XT1-XT3	AUX 250V AC	1SDA066422R1
XT1-XT3	AUX 24V DC	1SDA066423R1
Cabled version		
XT1	AUX-C 3Q 250V AC Left	1SDA066426R1
XT1-XT3	AUX-C 1Q+1SY 250V	1SDA066431R1
XT1-XT3	AUX-C 2Q+1SY 250V	1SDA066433R1
XT1-XT3	AUX-C 1Q+1SY 24V DC	1SDA066446R1
XT3	AUX-C 3Q+1SY 250V	1SDA066434R1
XT3	AUX-C 3Q+1SY 24V DC	1SDA066448R1
XT3	AUX-C 3Q 250V AC Left	1SDA066428R1



AUX cabled

Auxiliary contacts - AUX

Size	Type	Fixed/Plug-in	Withdrawable
Uncabled version			
XT2-XT4	AUX 250V AC	1SDA066422R1	
XT2-XT4	AUX-S51 250V AC	1SDA066424R1	
XT2-XT4	AUX 24V DC	1SDA066423R1	
XT2-XT4	AUX-S51 24V DC	1SDA066425R1	
Cabled version			
XT2-XT4	AUX-C 3Q 250V AC Left	1SDA066427R1	
XT2-XT4	AUX-C 1Q+1SY 250V AC	1SDA066431R1	1SDA066432R1
XT2-XT4	AUX-C 2Q+1SY 250V AC	1SDA066433R1	
XT2-XT4	AUX-C 2Q+2SY+1SA 250V AC	1SDA066438R1	1SDA066439R1
XT2-XT4	AUX-C 3Q+1SY 250V AC	1SDA066434R1	1SDA066435R1
XT2-XT4	AUX-C 3Q+2SY 250V AC	1SDA066436R1	1SDA066437R1
XT2-XT4	AUX-S51-C 250V AC	1SDA066429R1	1SDA066430R1
XT2-XT4	AUX-C 1Q+1SY 24V DC	1SDA066446R1	1SDA066447R1
XT2-XT4	AUX-C 3Q+1SY 24V DC	1SDA066448R1	1SDA066449R1
XT2-XT4	AUX-S51-C 24V DC	1SDA067116R1	1SDA067117R1
XT2-XT4	AUX-C 1Q+1SY 400V AC	1SDA066444R1	1SDA066445R1
XT2-XT4	AUX-C 2Q 400V AC	1SDA066440R1	1SDA066443R1



AUX for withdrawable

Auxiliary contacts - AUX

Size	Type	Fixed/Plug-in	Withdrawable
Uncabled version			
XT5	AUX 250V AC	1SDA066422R1	
XT5	AUX 24V DC	1SDA066423R1	
Cabled version			
XT5	AUX-C 1Q+1SY 250V AC left	1SDA104787R1	
XT5	AUX-C 1Q+1SY 250V AC	1SDA066431R1	1SDA104789R1
XT5	AUX-C 2Q+1SY 250V AC	1SDA066433R1	1SDA104796R1
XT5	AUX-C 3Q+1SY 250V AC	1SDA066434R1	1SDA104798R1
XT5	AUX-S51-C 250V AC	1SDA066429R1	1SDA104791R1
XT5	AUX-S52-C 250V AC	1SDA104800R1	1SDA104793R1
XT5	AUX-C 1Q+1SY 24V DC left	1SDA104786R1	
XT5	AUX-C 1Q+1SY 24V DC	1SDA066446R1	1SDA104788R1
XT5	AUX-C 3Q+1SY 24V DC	1SDA066448R1	1SDA104797R1
XT5	AUX-S51-C 24V DC	1SDA067116R1	1SDA104790R1
XT5	AUX-S52-C 24V DC	1SDA104799R1	1SDA104792R1
XT5	AUX-C 1Q+1SY 400V AC	1SDA104784R1	1SDA104785R1
XT5	AUX-C 2Q 400V AC	1SDA104795R1	1SDA104794R1

Auxiliary contacts - AUX

Size	Type	Fixed/Plug-in	Withdrawable
Uncabled version			
XT6	AUX 250V AC	1SDA066422R1	
XT6	AUX 24V DC	1SDA066423R1	
Cabled version			
XT6	AUX-C 1Q+1SY 250V AC	1SDA066431R1	1SDA104802R1
XT6	AUX-C 2Q+1SY 250V AC	1SDA066433R1	1SDA104807R1
XT6	AUX-C 3Q+1SY 250V AC	1SDA066434R1	1SDA104809R1
XT6	AUX-S51-C 250V AC	1SDA066429R1	1SDA104804R1
XT6	AUX-S52-C 250V AC	1SDA104800R1	1SDA104806R1
XT6	AUX-C 1Q+1SY 24V DC	1SDA066446R1	1SDA104801R1
XT6	AUX-C 3Q+1SY 24V DC	1SDA066448R1	1SDA104808R1
XT6	AUX-S51-C 24V DC	1SDA067116R1	1SDA104803R1
XT6	AUX-S52-C 24V DC	1SDA104799R1	1SDA104805R1

Ordering codes for accessories

Signaling



Open/close auxiliary contacts - AUX



Terminal for auxiliary connection

Auxiliary contacts - AUX

Size	Type	Fixed/ Withdrawable
XT7-XT7 M	AUX 4Q 400V	1SDA073750R1
XT7-XT7 M	AUX 4Q 24Vdc	1SDA073751R1
XT7-XT7 M	AUX 2Q 400VAC + 2Q 24VDC	1SDA073752R1
XT7-XT7 M	AUX S51 250V	1SDA073776R1
XT7-XT7 M	AUX S51 24V	1SDA073777R1
XT7	AUX 1SY 400V	1SDA104813R1
XT7	AUX 1SY 24V	1SDA104812R1
XT7	AUX 1S52 250V	1SDA104811R1
XT7	AUX 1S52 24V	1SDA104810R1
XT7 M	AUX 15Q 400V	1SDA073758R1
XT7 M	AUX 15Q 24V	1SDA073759R1
XT7 M	RTC 250V	1SDA073770R1
XT7 M	RTC 24V	1SDA073771R1
XT7 M	AUX S33 M/2 250V	1SDA104825R1
XT7 M	AUX S33 M/2 24V	1SDA104824R1

Terminals for auxiliary connection

Size	Type	Code
XT7-XT7 M	Terminals 10 pcs	1SDA073906R1



—
Auxiliary position
contact - AUP

Auxiliary position contacts - AUP

Auxiliary position contacts -AUP

Size	Type	Code
XT1-XT3	AUP-I – Four racked-in contacts 250V AC	1SDA066450R1
XT1-XT3	AUP-I – Four racked-in contacts 24V DC	1SDA066451R1
XT2-XT4	AUP-I – Four racked-in contacts 250V AC	1SDA066450R1
XT2-XT4	AUP-I – Four racked-in contacts 24V DC	1SDA066451R1
XT2-XT4	AUP-R – Two racked-out contacts 250V AC	1SDA066452R1
XT2-XT4	AUP-R – Two racked-out contacts 24V DC	1SDA066453R1
XT5-XT6	AUP-I – Three Racked-in contacts 250V AC	1SDA104815R1
XT5-XT6	AUP-I – Three Racked-in contacts 24V DC	1SDA104816R1
XT5-XT6	AUP-T – One Test contact 250V AC	1SDA104820R1
XT5-XT6	AUP-T – One Test contact 24V DC	1SDA104819R1
XT5-XT6	AUP-R – One Racked-out contact 250V AC	1SDA104817R1
XT5-XT6	AUP-R – One Racked-out contact 24V DC	1SDA104818R1
XT7-XT7 M	AUP 6 contacts 24V	1SDA073763R1
XT7-XT7 M	AUP 6 contacts 400V	1SDA073762R1

Early auxiliary contacts - AUE

Auxiliary contacts - AUX



—
Early auxiliary contacts
in the handle - AUE

Size	Type	Fixed/Plug-in	Withdrawable
XT1-XT3	AUE - Two contacts in rotary handle RHx (closed)	1SDA066454R1	
XT1-XT3	AUE - Two contacts in rotary handle RHx (open)	1SDA067118R1	
XT2-XT4	AUE - Two contacts in rotary handle RHx (closed)	1SDA066454R1	1SDA066455R1
XT2-XT4	AUE - Two contacts in rotary handle RHx (open)	1SDA067118R1	1SDA067119R1
XT5-XT6	AUE - Two contacts in rotary handle RHx (closed)	1SDA104821R1	1SDA104822R1
XT7	AUE - Two contacts in circuit-breaker (closed) ⁽¹⁾	1SDA104823R1	1SDA104823R1

(1) Contacts that can work only with a rotary handle

Ordering codes for accessories

Operating mechanism

Rotary and flange handle operating mechanism



Direct rotary handle - RHD



Transmitted rotary handle - RHE



Flange handle kit

Rotary handles XT1-XT3

Size	Type	Fixed/Plug-in
XT1-XT3	RHD Normal direct handle	1SDA066475R1
XT1-XT3	RHD Direct emergency handle	1SDA066477R1
XT1-XT3	RHE Normal transmitted handle	1SDA066479R1
XT1-XT3	RHE Emergency transmitted handle	1SDA066481R1
XT1-XT3	RHE-PL Normal extended handle +2PLL	1SDA080261R1
XT1-XT3	RHE-PL Emergency extended handle +2PLL	1SDA080314R1
XT1-XT3	RHS-L Normal left lateral handle	1SDA066579R1
XT1-XT3	RHS-L Emergency left lateral handle	1SDA066580R1
XT1-XT3	RHS-R Normal right lateral handle	1SDA066581R1
XT1-XT3	RHS-R Emergency right lateral handle	1SDA066582R1
Spare parts for transmitted handle		
XT1-XT3	RHE_B Base for transmitted Handle	1SDA066483R1
XT1-XT3	RHE-B base for extended handle +2PLL	1SDA080317R1
XT1-XT3	RHE_S Rod of 500mm	1SDA066576R1
XT1-XT3	RHE_H Normal transmitted handle	1SDA066577R1
XT1-XT3	RHE_H Emergency transmitted handle	1SDA066578R1
XT1-XT3	LH Normal large handle	1SDA066583R1
XT1-XT3	LH Large emergency handle	1SDA066585R1

Flange Handle XT1

Size	Type	Fixed
XT1	Flange handle kit L=4' NEMA 1, 3, 12, 4	1SDA080330R1
XT1	Flange handle kit L=6' NEMA 1, 3, 12, 4	1SDA080331R1
XT1	Flange handle kit L=10' NEMA 1, 3, 12, 4	1SDA080333R1
XT1	Flange handle kit L=4' NEMA 4X	1SDA082007R1
XT1	Flange handle kit L=6' NEMA 4X	1SDA082008R1
XT1	Flange handle kit L=10' NEMA 4X	1SDA082009R1
Spare parts for flange handle		
XT1	FH_H handle NEMA 1, 3, 12, 4	1SDA080346R1
XT1	FH_H handle NEMA 4X	1SDA082022R1

Flange Handle XT3

Size	Type	Fixed
XT3	Flange handle kit L=4' NEMA 1, 3, 12, 4	1SDA080338R1
XT3	Flange handle kit L=6' NEMA 1, 3, 12, 4	1SDA080339R1
XT3	Flange handle kit L=10' NEMA 1, 3, 12, 4	1SDA080341R1
XT3	Flange handle kit L=4' NEMA 4X	1SDA082013R1
XT3	Flange handle kit L=6' NEMA 4X	1SDA082014R1
XT3	Flange handle kit L=10' NEMA 4X	1SDA082015R1
Spare parts for flange handle		
XT3	FH_H handle NEMA 1, 3, 12, 4	1SDA080346R1
XT3	FH_H handle NEMA 4X	1SDA082022R1



Large handle - LH



Lateral handle - RHS

Rotary handles XT2-XT4

Size	Type	Fixed/Plug-in	Withdrawable
XT2-XT4	RHD Normal direct handle	1SDA069053R1	1SDA066476R1
XT2-XT4	RHD Direct emergency handle	1SDA069054R1	1SDA066478R1
XT2-XT4	RHE Normal transmitted handle	1SDA069055R1	1SDA066480R1
XT2-XT4	RHE Emergency transmitted handle	1SDA069056R1	1SDA066482R1
XT2-XT4	RHE-PL Normal extended handle +2PLL	1SDA080260R1	1SDA080262R1
XT2-XT4	RHE-PL Emergency extended handle +2PLL	1SDA080263R1	1SDA080315R1
XT2-XT4	RHS-L Normal left lateral handle	1SDA069058R1	
XT2-XT4	RHS-L Emergency left lateral handle	1SDA069059R1	
XT2-XT4	RHS-R Normal right lateral handle	1SDA069060R1	
XT2-XT4	RHS-R Emergency right lateral handle	1SDA069061R1	
Spare parts for transmitted handle			
XT2-XT4	RHE_B Base for transmitted handle	1SDA069057R1	1SDA066484R1
XT2-XT4	RHE-B base for extended handle +2PLL	1SDA080316R1	1SDA080318R1
XT2-XT4	RHE_S Rod of 500mm	1SDA066576R1	
XT2-XT4	Telescopic Rod kit	1SDA104869R1	
XT2-XT4	RHE_H Normal transmitted handle	1SDA066577R1	
XT2-XT4	RHE_H Emergency transmitted handle	1SDA066578R1	
XT2-XT4	LH Normal large handle	1SDA066583R1	
XT2-XT4	LH Large emergency handle	1SDA066585R1	

Flange Handle XT2

Size	Type	Fixed
XT2	Flange handle kit L=4' NEMA 1, 3, 12, 4	1SDA080334R1
XT2	Flange handle kit L=6' NEMA 1, 3, 12, 4	1SDA080335R1
XT2	Flange handle kit L=10' NEMA 1, 3, 12, 4	1SDA080337R1
XT2	Flange handle kit L=4' NEMA 4X	1SDA082010R1
XT2	Flange handle kit L=6' NEMA 4X	1SDA082011R1
XT2	Flange handle kit L=10' NEMA 4X	1SDA082012R1
Spare parts for flange handle		
XT2	FH_H handle NEMA 1, 3, 12, 4	1SDA080346R1
XT2	FH_H handle NEMA 4X	1SDA082022R1

Flange Handle XT4

Size	Type	Fixed
XT4	Flange handle kit L=4' NEMA 1, 3, 12, 4	1SDA080342R1
XT4	Flange handle kit L=6' NEMA 1, 3, 12, 4	1SDA080343R1
XT4	Flange handle kit L=10' NEMA 1, 3, 12, 4	1SDA080345R1
XT4	Flange handle kit L=4' NEMA 4X	1SDA082016R1
XT4	Flange handle kit L=6' NEMA 4X	1SDA082017R1
XT4	Flange handle kit L=10' NEMA 4X	1SDA082018R1
Spare parts for flange handle		
XT4	FH_H handle NEMA 1, 3, 12, 4	1SDA080346R1
XT4	FH_H handle NEMA 4X	1SDA082022R1

Ordering codes for accessories

Operating mechanism



(RHD) direct rotary handle + 2PLL

Rotary handles XT5

Size	Type	Fixed/Plug-in	Withdrawable
XT5	RHD Normal Direct Handle	1SDA104826R1	1SDA104828R1
XT5	RHD Normal Direct Handle + 2PLL	1SDA104827R1	1SDA104829R1
XT5	RHD Direct Emergency Handle	1SDA104830R1	1SDA104831R1
XT5	RHE Normal Transmitted Handle	1SDA104843R1	1SDA104844R1
XT5	RHE Emergency Transmitted Handle	1SDA104849R1	1SDA104850R1
Spare parts for transmitted handle			
XT5	RHE_B Base for Transmitted Handle	1SDA104845R1	1SDA104847R1
XT5	RHE_B Base for Transmitted Handle + 2PLL	1SDA104846R1	1SDA104848R1
XT5	RHE_S Rod of 500mm	1SDA113118R1	
XT5	Telescopic rod kit	1SDA104869R1	
XT5	RHE_H Normal Transmitted Handle	1SDA104851R1	1SDA104851R1
XT5	RHE_H Emergency Transmitted Handle	1SDA104852R1	1SDA104852R1
XT5	Conversion kit RHE->RHS	1SDA104870R1	



(RHE) extended rotary handle

Rotary handles XT6

Size	Type	Fixed	
XT6	RHD Normal Direct Handle	1SDA104832R1	1SDA104834R1
XT6	RHD Normal Direct Handle + 2PLL	1SDA104833R1	1SDA104835R1
XT6	RHD Direct Emergency Handle	1SDA104836R1	1SDA104837R1
XT6	RHE Normal Transmitted Handle	1SDA104853R1	1SDA104854R1
XT6	RHE Emergency Transmitted Handle	1SDA104859R1	1SDA104860R1
Spare parts for flange handle			
XT6	RHE_B Base for Transmitted Handle	1SDA104855R1	1SDA104857R1
XT6	RHE_B Base for Transmitted Handle + 2PLL	1SDA104856R1	1SDA104858R1
XT6	RHE_S Rod of 500mm	1SDA113118R1	
XT6	Telescopic rod kit	1SDA104869R1	
XT6	RHE_H Normal Transmitted Handle	1SDA104867R1	
XT6	RHE_H Emergency Transmitted Handle	1SDA104868R1	

Toggle Extension

Size	Type	Fixed/Plug-in	Withdrawable
XT5...XT7	Toggle extension XT5-XT6-XT7	1SDA104875R1	

RHE NFPA handle

Size	Type	Code
XT1...XT4	RHE NFPA handle	1SDA085244R1



NFPA handle



Direct rotary handle + 2PLL XT7 - RHD



Transmitted rotary handle + 2PLL XT7 - RHE

Rotary handles XT7

Size	Type	Fixed	Withdrawable
XT7	RHD Normal direct handle	1SDA104838R1	1SDA104838R1
XT7	RHD Normal direct handle + 2PLL	1SDA104839R1	1SDA104839R1
XT7	RHD Direct emergency handle	1SDA104840R1	1SDA104840R1
XT7	RHE Normal transmitted handle	1SDA104863R1	1SDA104863R1
XT7	RHE Emergency transmitted handle	1SDA104866R1	1SDA104866R1
Spare parts for transmitted handle			
XT7	RHE_B Base for transmitted handle	1SDA104864R1	1SDA104864R1
XT7	RHE_B Base for transmitted handle + 2PLL	1SDA104865R1	1SDA104865R1
XT7	RHE_S Rod of 500mm	1SDA113118R1	
XT7	Telescopic Rod kit	1SDA104869R1	
XT7	RHE_H Normal transmitted handle	1SDA104867R1	
XT7	RHE_H Emergency transmitted handle	1SDA104868R1	

Front for operating lever mechanism - FLD

Front for operating lever mechanism - FLD



Front for operating lever mechanism - FLD

Size	Type	Fixed/Plug-in	Withdrawable
XT2-XT4	Front for locks - FLD	1SDA066635R1	1SDA066636R1
XT5	Front for FLD locks	1SDA104871R1	1SDA104872R1
XT6	Front for FLD locks	1SDA104873R1	1SDA104874R1

Ordering codes for accessories

Remote control

Shunt Opening Release

Shunt opening release - SOR



SOR uncabled

Size	Type	Fixed/Plug-in	Withdrawable
Uncabled version			
XT1...XT4	SOR 12V DC	1SDA066313R1	
XT1...XT4	SOR 24-30V AC/DC	1SDA066314R1	
XT1...XT4	SOR 48-60V AC/DC	1SDA066315R1	
XT1...XT4	SOR 110...127V AC / 110...125V DC	1SDA066316R1	
XT1...XT4	SOR 220...240V AC / 220...250V DC	1SDA066317R1	
XT1...XT4	SOR 380-440V AC	1SDA066318R1	
XT1...XT4	SOR 480-525V AC	1SDA066319R1	
Cabled version			
XT1-XT3	SOR-C 12V DC	1SDA066321R1	
XT1-XT3	SOR-C 24-30V AC/DC	1SDA066322R1	
XT1-XT3	SOR-C 48-60V AC/DC	1SDA066323R1	
XT1-XT3	SOR-C 110-127V AC / 110-125V DC	1SDA066324R1	
XT1-XT3	SOR-C 220-240V AC / 220-250V DC	1SDA066325R1	
XT1-XT3	SOR-C 380-440V AC	1SDA066326R1	
XT1-XT3	SOR-C 480-525V AC	1SDA066327R1	
XT2-XT4	SOR-C 12V DC	1SDA066321R1	1SDA066328R1
XT2-XT4	SOR-C 24-30V AC/DC	1SDA066322R1	1SDA066329R1
XT2-XT4	SOR-C 48-60V AC/DC	1SDA066323R1	1SDA066330R1
XT2-XT4	SOR-C 110-127V AC / 110-125V DC	1SDA066324R1	1SDA066331R1
XT2-XT4	SOR-C 220-240V AC / 220-250V DC	1SDA066325R1	1SDA066332R1
XT2-XT4	SOR-C 380-440V AC	1SDA066326R1	1SDA066333R1
XT2-XT4	SOR-C 480-525V AC	1SDA066327R1	1SDA066334R1



SOR cabled



SOR for withdrawable version

Shunt opening release - YO

Size	Type	Fixed/Plug-in	Withdrawable
Uncabled version			
XT5-XT6	YO 12V DC	1SDA104924R1	
XT5-XT6	YO 24...60V AC/DC	1SDA104925R1	
XT5-XT6	YO 110..240 V AC - 110..250V DC	1SDA104926R1	
XT5-XT6	YO 380...440V AC	1SDA104927R1	
XT5-XT6	YO 440...525V AC		
Cabled version			
XT5	YO 12V DC	1SDA104932R1	1SDA104928R1
XT5	YO 24...60V AC/DC	1SDA104933R1	1SDA104929R1
XT5	YO 110..240V AC - 110..250V DC	1SDA104934R1	1SDA104930R1
XT5	YO 380...440V AC		
XT5	YO 440...525V AC		
XT6	YO 12V DC	1SDA104932R1	1SDA104936R1
XT6	YO 24...60V AC/DC	1SDA104933R1	1SDA104937R1
XT6	YO 110..240V AC - 110..250V DC	1SDA104934R1	1SDA104938R1
XT6	YO 380...440V AC		
XT6	YO 440...525V AC		



YO - shunt opening release



— Shunt opening release - YO

Shunt opening release -YO

Size	Type	Code
XT7-XT7 M	YO 24V AC/DC	1SDA073668R1
XT7-XT7 M	YO 30V AC/DC	1SDA073669R1
XT7-XT7 M	YO 48V AC/DC	1SDA073670R1
XT7-XT7 M	YO 60V AC/DC	1SDA073671R1
XT7-XT7 M	YO 110-120V AC/DC	1SDA073672R1
XT7-XT7 M	YO 120-127V AC/DC	1SDA073673R1
XT7-XT7 M	YO 220-240V AC/DC	1SDA073674R1
XT7-XT7 M	YO 240-250V AC/DC	1SDA073675R1
XT7-XT7 M	YO 380-400V AC	1SDA073677R1
XT7-XT7 M	YO 415-440V AC	1SDA073678R1
XT7-XT7 M	YO 480-500V AC	1SDA073679R1

Undervoltage release



— UVR uncabled

Undervoltage release - UVR

Size	Type	Fixed/Plug-in	Withdrawable
Uncabled version			
XT1...XT4	UVR 24-30V AC/DC	1SDA066389R1	
XT1...XT4	UVR 48V AC/DC	1SDA069064R1	
XT1...XT4	UVR 60V AC/DC	1SDA066390R1	
XT1...XT4	UVR 110...127V AC / 110...125V DC	1SDA066391R1	
XT1...XT4	UVR 220...240V AC / 220...250V DC	1SDA066392R1	
XT1...XT4	UVR 380-440V AC	1SDA066393R1	
XT1...XT4	UVR 480-525V AC	1SDA066394R1	
Cabled version			
XT1-XT3	UVR-C 24-30V AC/DC	1SDA066396R1	
XT1-XT3	UVR 48V AC/DC	1SDA069065R1	
XT1-XT3	UVR 60V AC/DC	1SDA066397R1	
XT1-XT3	UVR 110...127V AC / 110...125V DC	1SDA066398R1	
XT1-XT3	UVR 220...240V AC / 220...250V DC	1SDA066399R1	
XT1-XT3	UVR 380-440V AC	1SDA066400R1	
XT1-XT3	UVR 480-525V AC	1SDA066401R1	
XT2-XT4	UVR-C 24-30V AC/DC	1SDA066396R1	1SDA066403R1
XT2-XT4	UVR 48V AC/DC	1SDA069065R1	1SDA069066R1
XT2-XT4	UVR 60V AC/DC	1SDA066397R1	1SDA066404R1
XT2-XT4	UVR 110...127V AC / 110...125V DC	1SDA066398R1	1SDA066405R1
XT2-XT4	UVR 220...240V AC / 220...250V DC	1SDA066399R1	1SDA066406R1
XT2-XT4	UVR 380-440V AC	1SDA066400R1	1SDA066407R1
XT2-XT4	UVR 480-525V AC	1SDA066401R1	1SDA066408R1



— UVR cabled



— UVR for withdrawable

Ordering codes for accessories

Remote control



YU - undervoltage release

Undervoltage release - YU

Size	Type	Fixed/Plug-in	Withdrawable
Uncabled version			
XT5-XT6	YU 12 Vdc	1SDA104940R1	
XT5-XT6	YU 24...30 Vac/dc	1SDA104941R1	
XT5-XT6	YU 48...60 Vac/dc	1SDA104942R1	
XT5-XT6	YU 110..127 Vac - 110..125 Vdc	1SDA104943R1	
XT5-XT6	YU 220..240 Vac - 220..250 Vdc	1SDA104944R1	
XT5-XT6	YU 380...440 Vac	1SDA104945R1	
XT5-XT6	YU 480...525 Vac	1SDA104946R1	
Cabled version			
XT5	YU-C 12 Vdc	1SDA104954R1	1SDA104947R1
XT5	YU-C 24...30 Vac/dc	1SDA104955R1	1SDA104948R1
XT5	YU-C 48...60 Vac/dc	1SDA104956R1	1SDA104949R1
XT5	YU-C 110..127 Vac - 110..125 Vdc	1SDA104957R1	1SDA104950R1
XT5	YU-C 220..240 Vac - 220..250 Vdc	1SDA104958R1	1SDA104951R1
XT5	YU-C 380...440 Vac	1SDA104959R1	1SDA104952R1
XT5	YU-C 480...525 Vac	1SDA104960R1	1SDA104953R1
XT6	YU-C 12 Vdc	1SDA104954R1	1SDA104961R1
XT6	YU-C 24...30 Vac/dc	1SDA104955R1	1SDA104962R1
XT6	YU-C 48...60 Vac/dc	1SDA104956R1	1SDA104963R1
XT6	YU-C 110..127 Vac - 110..125 Vdc	1SDA104957R1	1SDA104964R1
XT6	YU-C 220..240 Vac - 220..250 Vdc	1SDA104958R1	1SDA104965R1
XT6	YU-C 380...440 Vac	1SDA104959R1	1SDA104966R1
XT6	YU-C 480...525 Vac	1SDA104960R1	1SDA104967R1

Undervoltage release - YU

Size	Type	Code
XT7-XT7 M	YU 24V AC/DC	1SDA073694R1
XT7-XT7 M	YU 30V AC/DC	1SDA073695R1
XT7-XT7 M	YU 48V AC/DC	1SDA073696R1
XT7-XT7 M	YU 60V AC/DC	1SDA073697R1
XT7-XT7 M	YU 110-120V AC/DC	1SDA073698R1
XT7-XT7 M	YU 120-127V AC/DC	1SDA073699R1
XT7-XT7 M	YU 220-240V AC/DC	1SDA073700R1
XT7-XT7 M	YU 240-250V AC/DC	1SDA073701R1
XT7-XT7 M	YU 380-400V AC	1SDA073703R1
XT7-XT7 M	YU 415-440V AC	1SDA073704R1
XT7-XT7 M	YU 480-500V AC	1SDA073705R1



Undervoltage release - YU



Closing release - YC

Closing release -YC

Size	Type	Code
XT7-XT7 M	YC 24V AC/DC	1SDA073681R1
XT7-XT7 M	YC 30V AC/DC	1SDA073682R1
XT7-XT7 M	YC 48V AC/DC	1SDA073683R1
XT7-XT7 M	YC 60V AC/DC	1SDA073684R1
XT7-XT7 M	YC 110-120V AC/DC	1SDA073685R1
XT7-XT7 M	YC 120-127V AC/DC	1SDA073686R1
XT7-XT7 M	YC 220-240V AC/DC	1SDA073687R1
XT7-XT7 M	YC 240-250V AC/DC	1SDA073688R1
XT7-XT7 M	YC 380-400V AC	1SDA073690R1
XT7-XT7 M	YC 415-440V AC	1SDA073691R1
XT7-XT7 M	YC 480-500V AC	1SDA073692R1

Shunt opening test unit**SOR/YO Test unit**

Size	Type	Code
XT1...XT7M	YO/YC test unit	1SDA082751R1

Delay device for undervoltage release - UVD**Delay device for undervoltage release -UVD**

Time delay device for undervoltage release - UVD

Size	Type	Code
XT1...XT4	UVD 24...30V AC/DC	1SDA051357R1
XT1...XT4	UVD 48...60V AC/DC	1SDA051358R1
XT1...XT4	UVD 110...125V AC/DC	1SDA051360R1
XT1...XT4	UVD 220...250V AC/DC	1SDA051361R1
XT5-XT6	UVD 24...30V AC/DC	1SDA101983R1
XT5-XT6	UVD 48...60V AC/DC	1SDA101984R1
XT5-XT6	UVD 110...125V AC/DC	1SDA101981R1
XT5-XT6	UVD 220...250V AC/DC	1SDA101982R1
XT7 - XT7 M	UVD 24/30V	1SDA038316R1
XT7 - XT7 M	UVD 48V	1SDA038317R1
XT7 - XT7 M	UVD 60V	1SDA038318R1
XT7 - XT7 M	UVD 110/127V	1SDA038319R1
XT7 - XT7 M	UVD 220/250V	1SDA038320R1

Ordering codes for accessories

Remote control

Connectors for shunt opening and undervoltage release for withdrawable version



Fixed/Moving part connector for withdrawable

Connectors for shunt opening and undervoltage release for withdrawable version

Size	Type	Code
Connector of 4th pole for withdrawable version		
XT2-XT4	Connector 4th pole SOR	1SDA066415R1
XT2-XT4	Connector 4th pole UVR	1SDA066418R1
Connector of 3rd pole for withdrawable version		
XT5	Connector 3rd pole YO	1SDA104968R1
XT5	Connector 3rd pole YU	1SDA104970R1



Remote reset - YR

Remote reset - YR

Remote reset - YR

Size	Type	Code
XT7 M	YR 24V DC	1SDA073744R1
XT7 M	YR 110V AC/DC	1SDA073745R1
XT7 M	YR 220V AC/DC	1SDA073746R1

Motor operator

Direct action motor operator - MOD



Motor operator - MOD

Size	Type	Code
XT1-XT3	MOD 24V DC	1SDA066457R1
XT1-XT3	MOD 48...60V DC	1SDA066458R1
XT1-XT3	MOD 110...125V AC/DC	1SDA066459R1
XT1-XT3	MOD 220...250V AC/DC	1SDA066460R1
XT1-XT3	MOD 380...440V AC	1SDA066461R1
XT1-XT3	MOD 480...525V AC	1SDA066462R1



Motor operator - MOE

Stored energy motor operator - MOE

Size	Type	Code
XT2-XT4	XT2-XT4 MOE 24V DC	1SDA066463R1
XT2-XT4	XT2-XT4 MOE 48...60V DC	1SDA066464R1
XT2-XT4	XT2-XT4 MOE 110...125V AC/DC	1SDA066465R1
XT2-XT4	XT2-XT4 MOE 220...250V AC/DC	1SDA066466R1
XT2-XT4	XT2-XT4 MOE 380...440V AC	1SDA066467R1
XT2-XT4	XT2-XT4 MOE 480...525V AC	1SDA066468R1
XT5	XT5 MOE 24V DC	1SDA104879R1
XT5	XT5 MOE 48...60V DC	1SDA104881R1
XT5	XT5 MOE 110...125V AC/DC	1SDA104883R1
XT5	XT5 MOE 220...250V AC/DC	1SDA104885R1
XT5	XT5 MOE 380V AC	1SDA104887R1
XT6	XT6 MOE 24V DC	1SDA104889R1
XT6	XT6 MOE 48...60V DC	1SDA104891R1
XT6	XT6 MOE 110...125V AC/DC	1SDA104893R1
XT6	XT6 MOE 220...250V AC/DC	1SDA104895R1
XT6	XT6 MOE 380V AC	1SDA104897R1
XT6	XT6 MOE 24V DC Fast opening	1SDA104890R1
XT6	XT6 MOE 48...60V DC Fast opening	1SDA104892R1
XT6	XT6 MOE 110...125V AC/DC Fast opening	1SDA104894R1
XT6	XT6 MOE 220...250V AC/DC Fast opening	1SDA104896R1
XT6	XT6 MOE 380V AC Fast opening	1SDA104898R1

Ordering codes for accessories

Remote control



Motor operator - MOE

Electronic stored energy motor operator - MOE-E

Size	Type	Code
XT2-XT4	XT2-XT4 MOE-E 24V DC	1SDA066469R1
XT2-XT4	XT2-XT4 MOE-E 48...60V DC	1SDA066470R1
XT2-XT4	XT2-XT4 MOE-E 110...125V AC/DC	1SDA066471R1
XT2-XT4	XT2-XT4 MOE-E 220...250V AC/DC	1SDA066472R1
XT2-XT4	XT2-XT4 MOE-E 380...440V AC	1SDA066473R1
XT2-XT4	XT2-XT4 MOE-E 480...525V AC	1SDA066474R1
XT5	XT5 MOE-E 24V DC	1SDA104899R1
XT5	XT5 MOE-E 48...60V DC	1SDA104901R1
XT5	XT5 MOE-E 110...125V AC/DC	1SDA104903R1
XT5	XT5 MOE-E 220...250V AC/DC	1SDA104905R1
XT5	XT5 MOE-E 380V AC	1SDA104907R1



Spring charging motor - M

Spring charging motor - M

Size	Type	Code
XT7 M	M 24-30 V AC/DC	1SDA104919R1
XT7 M	M 48-60 V AC/DC	1SDA104920R1
XT7 M	M 100-130 V AC/DC	1SDA104921R1
XT7 M	M 220-250 V AC/DC	1SDA104922R1
XT7 M	M 380-415 V AC/DC	1SDA104923R1

Ordering codes for accessories

Safety and protection



Terminal cover

Terminals covers and phase separators

Insulating terminal covers

Size	Type	3 poles	4 poles
XT1	LTC Low terminal covers	1SDA066655R1	1SDA066656R1
XT1	HTC High terminal covers	1SDA066664R1	1SDA066665R1
XT2	LTC Low terminal covers	1SDA066657R1	1SDA066659R1
XT2	HTC High terminal covers	1SDA066666R1	1SDA066667R1
XT3	LTC Low terminal covers	1SDA066660R1	1SDA066661R1
XT3	HTC High terminal covers	1SDA066668R1	1SDA066669R1
XT4	LTC Low terminal covers	1SDA066662R1	1SDA066663R1
XT4	HTC High terminal covers	1SDA066670R1	1SDA066671R1
XT5	LTC Low terminal covers	1SDA105018R1	1SDA105019R1
XT5	HTC High terminal covers	1SDA105025R1	1SDA105026R1
XT5	HTC_BS High terminal covers with back shield	1SDA105043R1	1SDA105044R1
XT5	HTC_ES High terminal covers for ES	1SDA105031R1	1SDA105032R1
XT5	HTC_ES_BS High terminal covers for ES with back shield	1SDA105037R1	1SDA105038R1
XT5	HTC - XT5 FP RC 4p		1SDA105024R1
XT6	LTC Low terminal covers	1SDA105020R1	1SDA105021R1
XT6	HTC High terminal covers	1SDA105027R1	1SDA105028R1
XT6	HTC_BS High terminal covers with back shield	1SDA105045R1	1SDA105046R1
XT6	HTC_ES High terminal covers for ES	1SDA105033R1	1SDA105034R1
XT6	HTC_ES_BS High terminal covers for ES with back shield	1SDA105039R1	1SDA105040R1
XT7-XT7 M	LTC Low terminal covers	1SDA107475R1	1SDA107476R1
XT7-XT7 M	LTC Low terminal covers for W	1SDA105022R1	1SDA105023R1
XT7-XT7 M	HTC High terminal covers	1SDA105029R1	1SDA105030R1
XT7-XT7 M	HTC High terminal covers form 4	1SDA105047R1	1SDA105048R1
XT7-XT7 M	HTC_ES High terminal covers for ES	1SDA105035R1	1SDA105036R1
XT7-XT7 M	HTC_ES High terminal covers for ES form 4	1SDA105041R1	1SDA105042R1

Insulating Plates

Size	Type	Code	
XT5	Terminal insulating plate XT5 fixed	1SDA112971R1	1SDA112972R1

Ordering codes for accessories

Safety and protection



Sealable screw



Phase separators

Sealable screws for terminal covers

Size	Type	Code
XT1...XT4	Kit with two sealable screws	1SDA066672R1

Phase separators for circuit-breaker

Size	Type	4 pcs	6 pcs
XT1-XT3	PB height 0.98in/25mm	1SDA075913R1	1SDA075919R1
XT1-XT3	PB height 3.94in/100mm	1SDA075916R1	1SDA075922R1
XT1-XT3	PB height 7.87in/200mm	1SDA075918R1	1SDA075924R1
XT2-XT4	PB height 0.98in/25mm	1SDA075914R1	1SDA075920R1
XT2-XT4	PB height 3.94in/100mm	1SDA075915R1	1SDA075921R1
XT2-XT4	PB height 7.87in/200mm	1SDA075917R1	1SDA075923R1
XT5	PB Height 25mm	1SDA107805R1	1SDA107806R1
XT5	PB Height 100mm	1SDA107801R1	1SDA107802R1
XT5	PB Height 200mm	1SDA107803R1	1SDA107804R1
XT6	PB Height 100mm	1SDA107807R1	1SDA107808R1
XT6	PB Height 200mm	1SDA107809R1	1SDA107810R1

Phase separators for fixed parts

Size	Type	4 pcs	6 pcs
XT1	PS - Rear phase separators for FP	1SDA068953R1	1SDA068954R1
XT2	PS - Rear phase separators for FP	1SDA068953R1	1SDA068954R1
XT3	PS - Rear phase separators for FP	1SDA068953R1	1SDA068954R1
XT4	PS - Rear phase separators for FP	1SDA068953R1	1SDA068954R1
XT5	PS - Rear phase separators for FP	1SDA105008R1	1SDA105009R1
Size	Type	2 pcs	3 pcs
XT7-XT7M	PS - Phase separators for FP W	1SDA076164R1	1SDA076165R1

IP Protection

IP Protection for rotary handles



IP54 protection for RHE

Size	Type	Code
XT1...XT4	IP54 protection for RHE	1SDA066587R1
XT5	IP54 protection for RHD	1SDA104876R1
XT6	IP54 protection for RHD	1SDA104877R1
XT7	IP54 protection for RHD	1SDA104878R1

IP Protection for motor operators



IP54 protection for XT7 M

Size	Type	Code
XT5	IP54 Flange different keys for MOE	1SDA105105R1
XT5	IP54 Flange same keys for MOE	1SDA105106R1
XT6	IP54 Flange different keys for MOE	1SDA105107R1
XT6	IP54 Flange same keys for MOE	1SDA105108R1
XT7 M	IP54 Flange with different keys	1SDA073866R1
XT7 M	IP54 Flange with the same keys	1SDA073868R1

MOC

Mechanical operation counter - MOC



Mechanical operation counter - MOC

Size	Type	Code
XT7 M	Mechanical operation counter	1SDA101969R1

Ordering codes for accessories

Safety and protection

Keylocks and padlocks

Keylock/padlock for fixed part of withdrawable



Keylock/padlock for fixed part



Key lock in racked-in/test/racked-out position - KLP



Padlock in racked-in/test/racked-out position - PLP

Size	Type	Code
XT2-XT4	KL-D Keylock FP, Giussani different keys	1SDA066293R1
XT2-XT4	KL-S Keylock FP, Giussani same keys N.20005	1SDA066294R1
XT2-XT4	KL-D Keylock FP, Ronis 1228 different keys	1SDA066298R1
XT2-XT4	KL-S Keylock FP, Ronis 1228 same keys Type A keys	1SDA066300R1
XT5-XT6	KL-D Keylock FP, Giussani different keys	1SDA105112R1
XT5-XT6	KL-S Keylock FP, Giussani same keys N.20005	1SDA105113R1
XT5-XT6	KL-D Keylock FP, Ronis 1228 different keys	1SDA105109R1
XT5-XT6	KL-S Keylock FP, Ronis 1228 same keys Type A keys	1SDA105114R1
XT5-XT6	KL_A Ronis Arrangement 1104 FP	1SDA105110R1
XT5-XT6	KL_A STI Arrangement FP	1SDA105111R1
XT7-XT7 M	KLP-A Bl. Racked in/out Castell XT7-XT7 M 1st key	1SDA073836R1
XT7-XT7 M	KLP-A Bl. Racked in/out Castell XT7-XT7 M 2nd key	1SDA073837R1
XT7-XT7 M	KLP-A Bl. Racked in/out RonProf Kirk XT7-XT7 M 1st key	1SDA073834R1
XT7-XT7 M	KLP-A Bl. Racked in/out RonProf Kirk XT7-XT7 M 2nd key	1SDA073835R1
XT7-XT7 M	KLP-A Pos.lock Ronis-STI 1key	1SDA085737R1
XT7-XT7 M	KLP-A Pos.lock Ronis-STI 2key	1SDA085738R1
XT7-XT7 M	KLP-D Bl. Racked in/out XT7-XT7 M 1st key	1SDA073822R1
XT7-XT7 M	KLP-D Bl. Racked in/out XT7-XT7 M 2nd key	1SDA073828R1
XT7-XT7 M	KLP-S Bl. Racked in/out N.20005 XT7-XT7 M 1st key	1SDA073823R1
XT7-XT7 M	KLP-S Bl. Racked in/out N.20005 XT7-XT7 M 2nd key	1SDA073829R1
XT7-XT7 M	KLP-S Bl. Racked in/out N.20006 XT7-XT7 M 1st key	1SDA073824R1
XT7-XT7 M	KLP-S Bl. Racked in/out N.20006 XT7-XT7 M 2nd key	1SDA073830R1
XT7-XT7 M	KLP-S Bl. Racked in/out N.20007 XT7-XT7 M 1st key	1SDA073825R1
XT7-XT7 M	KLP-S Bl. Racked in/out N.20007 XT7-XT7 M 2nd key	1SDA073831R1
XT7-XT7 M	KLP-S Bl. Racked in/out N.20008 XT7-XT7 M 1st key	1SDA073826R1
XT7-XT7 M	KLP-S Bl. Racked in/out N.20008 XT7-XT7 M 2nd key	1SDA073832R1
XT7-XT7 M	KLP-S Bl. Racked in/out N.20009 XT7-XT7 M 1st key	1SDA073827R1
XT7-XT7 M	KLP-S Bl. Racked in/out N.20009 XT7-XT7 M 2nd key	1SDA073833R1
XT7-XT7 M	Suppl. locks in racked-out XT7-XT7 M	1SDA073838R1
XT7-XT7 M	PLP Bl. padlocks Racked in/out D=4/6/8mm	1SDA073840R1



Fixed padlock in the open position - PLL



Padlock in the open position - PLC



Removable padlock in the open position



Key lock on the circuit-breaker

Circuit-breaker padlock

Size	Type	Code
XT1-XT3	PLL Removable lock with padlocks in open position	1SDA066588R1
XT1-XT3	PLL Fixed lock with padlocks in open position	1SDA066589R1
XT1-XT3	PLL Fixed lock with padlocks in open/closed position	1SDA066591R1
XT2-XT4	PLL Fixed lock with padlocks in open position	1SDA066590R1
XT2-XT4	PLL Fixed lock with padlocks in open/closed position	1SDA066592R1
XT5	PLL Removable lock with padlocks in open position	1SDA105100R1
XT5	PLL Fixed lock with padlocks in open position	1SDA105099R1
XT5	PLL Fixed lock with padlocks in open/closed position	1SDA105098R1
XT6	PLL Removable lock with padlocks in open position	1SDA105103R1
XT6	PLL Fixed lock with padlocks in open position	1SDA105102R1
XT6	PLL Fixed lock with padlocks in open/closed position	1SDA105101R1
XT7	PLL Fixed lock with padlocks in open position	1SDA105104R1
XT7 M	PLC Padlocks in open position D=4mm	1SDA073800R1
XT7 M	PLC Padlocks in open position D=7mm	1SDA073801R1
XT7 M	PLC Padlocks in open position D=8mm	1SDA073802R1

Keylock for circuit-breaker - KLC

Size	Type	Code
XT1	KLC Ronis key lock open, different keys, removable in open position	1SDA066593R1
XT1	KLC Ronis key lock open, same Type A keys, removable in open position	1SDA066594R1
XT1	KLC Ronis key lock open, same Type B keys, removable in open position	1SDA066595R1
XT1	KLC Ronis key lock open, same Type C keys, removable in open position	1SDA066596R1
XT1	KLC Ronis key lock open, same Type D keys, removable in open position	1SDA066597R1
XT1	KLC Ronis key lock open, same keys, removable in both position	1SDA066598R1
XT3	KLC Ronis key lock open, different keys, removable in open position	1SDA066605R1
XT3	KLC Ronis key lock open, same Type A keys, removable in open position	1SDA066606R1
XT3	KLC Ronis key lock open, same Type B keys, removable in open position	1SDA066607R1
XT3	KLC Ronis key lock open, same Type C keys, removable in open position	1SDA066608R1
XT3	KLC Ronis key lock open, same Type D keys, removable in open position	1SDA066609R1
XT3	KLC Ronis key lock open, same keys, removable in both position	1SDA066610R1
XT2-XT4	KLC Ronis key lock open, different keys, removable in open position	1SDA066599R1
XT2-XT4	KLC Ronis key lock open, same Type A keys, removable in open position	1SDA066600R1
XT2-XT4	KLC Ronis key lock open, same Type B keys, removable in open position	1SDA066601R1
XT2-XT4	KLC Ronis key lock open, same Type C keys, removable in open position	1SDA066602R1
XT2-XT4	KLC Ronis key lock open, same Type D keys, removable in open position	1SDA066603R1
XT2-XT4	KLC Ronis key lock open, same keys, removable in both position	1SDA066604R1

Ordering codes for accessories

Safety and protection



Keylock on the circuit-breaker

Keylock for circuit-breaker - KLC

Size	Type	Code
XT5-XT6	KLC Ronis key lock open, different keys, removable in open position	1SDA105066R1
XT5-XT6	KLC Ronis key lock open, same Type A keys, removable in open position	1SDA105062R1
XT5-XT6	KLC Ronis key lock open, same Type B keys, removable in open position	1SDA105063R1
XT5-XT6	KLC Ronis key lock open, same Type C keys, removable in open position	1SDA105064R1
XT5-XT6	KLC Ronis key lock open, same Type D keys, removable in open position	1SDA105065R1
XT5-XT6	KLC Ronis key lock open, same keys, removable in both position	1SDA105061R1
XT5-XT6	KLC-A Kirk key lock	1SDA105067R1
XT5-XT6	KLC-A Ronis 1104 key lock	1SDA105068R1
XT5-XT6	KLC-A STI key lock	1SDA105069R1
XT7	KLC Ronis key lock open, different keys, removable in open position	1SDA105075R1
XT7	KLC Ronis key lock open, same Type A keys, removable in open position	1SDA105071R1
XT7	KLC Ronis key lock open, same Type B keys, removable in open position	1SDA105072R1
XT7	KLC Ronis key lock open, same Type C keys, removable in open position	1SDA105073R1
XT7	KLC Ronis key lock open, same Type D keys, removable in open position	1SDA105074R1
XT7	KLC Ronis key lock open, same keys, removable in both position	1SDA105070R1
XT7	KLC-A Kirk key lock	1SDA105076R1
XT7	KLC-A Ronis 1104 key lock	1SDA105077R1
XT7	KLC-A STI key lock	1SDA105078R1
XT7	KLC-A Castell key lock	1SDA105149R1
XT7 M	KLC-D Key lock open	1SDA107494R1
XT7 M	KLC-S Key lock open N.20005	1SDA107495R1
XT7 M	KLC-S Key lock open N.20006	1SDA107496R1
XT7 M	KLC-S Key lock open N.20007	1SDA107497R1
XT7 M	KLC-S Key lock open N.20008	1SDA107498R1
XT7 M	KLC-S Key lock open N.20009	1SDA107499R1
XT7 M	KLC-A Castell key lock open ⁽¹⁾	1SDA107500R1
XT7 M	KLC-A Kirk key lock open	1SDA101967R1
XT7 M	KLC-A Ronis 1104 - STI key lock open	1SDA101968R1

(1) Arrangement factory mounted only



Key lock in open position - KLC



Key lock on the handle

Keylock for the RH / FLD

Size	Type	Code
XT1...XT4	RHL Ronis key lock open, different keys – RHx/FLD	1SDA066617R1
XT1...XT4	RHL Ronis key lock open, same Type A keys – RHx/FLD	1SDA066618R1
XT1...XT4	RHL Ronis key lock open, same Type B keys - RHx/FLD	1SDA066619R1
XT1...XT4	RHL Ronis key lock open, same Type C keys - RHx/FLD	1SDA066620R1
XT1...XT4	RHL Ronis key lock open, same Type D keys - RHx/FLD	1SDA066621R1
XT1...XT4	RHL Ronis key lock open/closed, different keys - RHx	1SDA066622R1
XT1...XT4	RHL Ronis key lock open/closed, different keys - FLD	1SDA069182R1
XT5	RHL Ronis key lock open, different keys – RHx/FLD	1SDA105081R1
XT5	RHL Ronis key lock open, same Type A keys – RHx/FLD	1SDA105082R1
XT5	RHL Ronis key lock open, same Type B keys - RHx/FLD	1SDA105083R1
XT5	RHL Ronis key lock open, same Type C keys - RHx/FLD	1SDA105084R1
XT5	RHL Ronis key lock open, same Type D keys - RHx/FLD	1SDA105085R1
XT5	RHL Ronis key lock open/closed, different keys – RHx/FLD	1SDA105080R1
XT6	RHL Ronis key lock open, different keys – FLD	1SDA105091R1
XT6	RHL Ronis key lock open, same Type A keys – FLD	1SDA105086R1
XT6	RHL Ronis key lock open, same Type B keys - FLD	1SDA105087R1
XT6	RHL Ronis key lock open, same Type C keys - FLD	1SDA105088R1
XT6	RHL Ronis key lock open, same Type D keys - FLD	1SDA105089R1
XT6	RHL Ronis key lock open/closed, different keys – FLD	1SDA105090R1
XT6 - XT7	RHL Ronis key lock open, different keys – RHx	1SDA105091R1
XT6 - XT7	RHL Ronis key lock open, same Type A keys – RHx	1SDA105086R1
XT6 - XT7	RHL Ronis key lock open, same Type B keys - RHx	1SDA105087R1
XT6 - XT7	RHL Ronis key lock open, same Type C keys - RHx	1SDA105088R1
XT6 - XT7	RHL Ronis key lock open, same Type D keys - RHx	1SDA105089R1
XT6 - XT7	RHL Ronis key lock open/closed, different keys – RHx	1SDA105090R1

Keylock on the panel door with RHE

Size	Type	Code
XT5-XT6	RHL Ronis key lock open, different keys on the panel door	1SDA105079R1

Ordering codes for accessories

Safety and protection



Key lock on the motor

Keylock on the motor

Size	Type	Code
XT1-XT3	MOL-D Ronis key lock open, different keys	1SDA066623R1
XT1-XT3	MOL-S Ronis key lock open, same Type A keys	1SDA066624R1
XT1-XT3	MOL-S Ronis key lock open, same Type B keys	1SDA066625R1
XT1-XT3	MOL-S Ronis key lock open, same Type C keys	1SDA066626R1
XT1-XT3	MOL-S Ronis key lock open, same Type D keys	1SDA066627R1
XT2-XT4	MOL-D Ronis key lock open, different keys	1SDA066629R1
XT2-XT4	MOL-S Ronis key lock open, same Type A keys	1SDA066630R1
XT2-XT4	MOL-S Ronis key lock open, same Type B keys	1SDA066631R1
XT2-XT4	MOL-S Ronis key lock open, same Type C keys	1SDA066632R1
XT2-XT4	MOL-S Ronis key lock open, same Type D keys	1SDA066633R1
XT2-XT4	MOL-M Key lock against manual operation	1SDA066634R1
XT5-XT6	MOL-D Ronis key lock open, different keys	1SDA105092R1
XT5-XT6	MOL-S Ronis key lock open, same Type A keys	1SDA105094R1
XT5-XT6	MOL-S Ronis key lock open, same Type B keys	1SDA105095R1
XT5-XT6	MOL-S Ronis key lock open, same Type C keys	1SDA105096R1
XT5-XT6	MOL-S Ronis key lock open, same Type D keys	1SDA105097R1
XT5-XT6	MOL-M Key lock against manual operation	1SDA105093R1

Sealable lock on thermal setting

Size	Type	Code
XT1-XT3	Lock on thermal setting for TMD trip unit	1SDA066651R1

Protection device for opening and closing pushbuttons - PBC

Size	Type	Code
XT7 M	PBC Prot. Pushbuttons AP/CH	1SDA073854R1
XT7 M	PBC Prot. Pushbuttons AP/CH D=4mm	1SDA073857R1
XT7 M	PBC Prot. Pushbuttons AP/CH D=7mm	1SDA073856R1
XT7 M	PBC Prot. Pushbuttons AP/CH D=8mm	1SDA073855R1



Protection device for opening and closing pushbuttons - PBC

Lock to prevent door opening when the circuit-breaker is in the closed position - DLC

Size	Type	Code
XT7-XT7 M	DLC interlock direct door for fixed to wall	1SDA079779R1
XT7-XT7 M	DLC interlock direct door for fixed to floor	1SDA079780R1
XT7-XT7 M	DLC interlock direct door for fixed part withdrawable	1SDA079781R1
XT7-XT7 M	DLC interlock cable door for fixed to wall	1SDA081032R1
XT7-XT7 M	DLC interlock cable door for fixed to floor	1SDA081033R1
XT7-XT7 M	DLC interlock cable door for fixed part withdrawable	1SDA081034R1



Lock to prevent door opening when the circuit-breaker is in the closed position - DLC

Flanges

Flanges for circuit-breakers and frontal accessories

Size	Type	3 poles	4 poles
XT1	Small flange for circuit-breaker	1SDA068657R1	1SDA068657R1
XT1	Large flange for circuit-breaker	1SDA068639R1	1SDA068640R1
XT1	Flange MOD	1SDA068648R1	1SDA068648R1
XT1	Flange for direct handle RHD	1SDA068651R1	1SDA068651R1
XT1	Flange for residual current RC Sel / Inst	1SDA068653R1	1SDA068654R1
XT2	Small flange for circuit-breaker	1SDA068657R1	1SDA068657R1
XT2	Large flange for circuit-breaker	1SDA068641R1	1SDA068642R1
XT2	Flange for MOE/MOE-E/FLD	1SDA068649R1	1SDA068649R1
XT2	Flange for MOE/MOE-E/FLD W	1SDA068650R1	1SDA068650R1
XT2	Flange for direct handle RHD	1SDA068651R1	1SDA068651R1
XT2	Flange for direct handle RHD W	1SDA068652R1	1SDA068652R1
XT2	Flange for residual current RC Sel		1SDA066647R1
XT2	Flange for residual current RC Sel W		1SDA066648R1
XT3	Small flange for circuit-breaker	1SDA068657R1	1SDA068657R1
XT3	Large flange for circuit-breaker	1SDA068644R1	1SDA068645R1
XT3	Flange for MOD	1SDA068648R1	1SDA068648R1
XT3	Flange for direct handle RHD	1SDA068651R1	1SDA068651R1
XT3	Flange for residual current RC Sel/RC Inst	1SDA068655R1	1SDA068656R1
XT4	Small flange for circuit-breaker	1SDA068657R1	1SDA068657R1
XT4	Large flange for circuit-breaker	1SDA068646R1	1SDA068647R1
XT4	Flange for MOE/MOE-E/FLD	1SDA068649R1	1SDA068649R1
XT4	Flange for MOE/MOE-E/FLD W	1SDA068650R1	1SDA068650R1
XT4	Flange for direct handle RHD	1SDA068651R1	1SDA068651R1
XT4	Flange for direct handle RHD W	1SDA068652R1	1SDA068652R1
XT4	Flange for residual current RC Sel		1SDA066649R1
XT4	Flange for residual current RC Sel W		1SDA066650R1
XT5	Flange for circuit-breaker	1SDA105139R1	1SDA105139R1
XT5	Flange for MOE/MOE-E/FLD/RHD	1SDA105137R1	1SDA105137R1
XT5	Flange for MOE/MOE-E/FLD/RHD W	1SDA105138R1	1SDA105138R1
XT5	Flange for residual current RC Sel		1SDA105135R1
XT5	Flange for residual current RC Sel W		1SDA105136R1
XT6	Flange for circuit-breaker	1SDA105142R1	1SDA105142R1
XT6	Flange for MOE/FLD/RHD	1SDA105140R1	1SDA105140R1
XT6	Flange for MOE/FLD/RHD W	1SDA105141R1	1SDA105141R1
XT7	Flange for RHD	1SDA105143R1	1SDA105143R1
XT7-XT7 M	IP30 Flange XT7-XT7 M	1SDA073862R1	1SDA073862R1
XT7-XT7 M	IP30 Flange XT7-XT7 M W	1SDA073863R1	1SDA073863R1



— Flange for circuit-breaker



— Flange for circuit-breaker for the withdrawable version



— Flange for circuit-breaker

Ordering codes for accessories

Interlocks and switching devices

Automatic transfer devices

Rear mechanical interlock



Rear mechanical interlock - MIR-H



Plate for rear mechanical interlock

Size	Type	Code
XT1-XT2-XT3-XT4 chassis		
XT1...XT4	MIR-H	1SDA066637R1
XT1...XT4	MIR-V	1SDA066638R1
XT1	Plate XT1 F	1SDA066639R1
XT1	Plate XT1 P	1SDA066640R1
XT2	Plate XT2 F	1SDA066641R1
XT2	Plate XT2 P/W	1SDA066642R1
XT3	Plate XT3 F	1SDA066643R1
XT3	Plate XT3 P	1SDA066644R1
XT4	Plate XT4 F	1SDA066645R1
XT4	Plate XT4 P/W	1SDA066646R1
XT4	Plate for XT4 F with XT5 MIR	1SDA105121R1
XT4	Plate for XT4 W/P with XT5 MIR	1SDA105125R1
XT5 chassis		
XT5	MIR-H	1SDA105117R1
XT5	MIR-V	1SDA105119R1
XT5	Plate XT5 F	1SDA105122R1
XT5	Plate XT5 P/W 400A	1SDA105123R1
XT5	Plate XT5 P/W 630A	1SDA105124R1
XT5	Plate XT5 F for XT6 interlock	1SDA101988R1
XT5	Plate XT5 W/P 400 for XT6 interlock	1SDA101989R1
XT5	Plate XT5 W/P 630 for XT6 interlock	1SDA101990R1
XT6 chassis		
XT6	MIR-H	1SDA105118R1
XT6	MIR-V	1SDA105120R1
XT6	Plate XT6 F	1SDA105126R1
XT6	Plate XT6 W	1SDA105127R1

Note: If the CB interlocked has a stored energy motor operator (MOE/MOE-E) a key lock between the MOL-D and MOL-S is mandatory

Cable interlock

Size	Type	Code
XT7-XT7 M	Type A horizontal	1SDA073881R1
XT7-XT7 M	Type A vertical	1SDA073885R1
XT7-XT7 M	Support for mechanical interlock FP Type A	1SDA073896R1
XT7-XT7 M	Support for mechanical interlock for fixed CB Type A - floor mounted	1SDA073893R1
XT7-XT7 M	Support for mechanical interlock for fixed CB Type A - wall mounted	1SDA073894R1
XT7-XT7 M	Type B, C, D horizontal	1SDA073882R1
XT7-XT7 M	Type B, C, D vertical	1SDA073886R1
XT7-XT7 M	Support for mechanical interlock FP Type C	1SDA101985R1
XT7-XT7 M	Support for mechanical interlock for fixed CB Type C - floor mounted	1SDA101986R1
XT7-XT7 M	Support for mechanical interlock for fixed CB Type C - wall mounted	1SDA101987R1
XT7-XT7 M	Support for mechanical interlock FP Type B-D	1SDA105128R1
XT7-XT7 M	Support for mechanical interlock for fixed CB Type B-D - floor mounted	1SDA105129R1
XT7-XT7 M	Support for mechanical interlock for fixed CB Type B-D - wall mounted	1SDA105130R1



ATS021- ATS022
Automatic transfer
devices

ATS021 - ATS022 Automatic transfer devices

Size	Type	Code
XT1...XT7 M	ATS021 Automatic multi voltage transfer device	1SDA065523R1
XT1...XT7 M	ATS022 Automatic advanced control transfer device	1SDA065524R1

Ordering codes for accessories

Residual current devices

Residual current devices

Residual current devices



RC Inst / RC Sel



RC Sel

Size	Type	3 poles	4 poles
XT1	RC Sel Low 200mm		1SDA067121R1
XT1	XT1 RC Inst	1SDA067122R1	1SDA067124R1
XT1	XT1 RC Sel	1SDA067123R1	1SDA067125R1
XT2	XT2 RC Sel		1SDA067126R1
XT3	XT3 RC Inst	1SDA067127R1	1SDA067129R1
XT3	XT3 RC Sel	1SDA067128R1	1SDA067130R1
XT3	XT3 RC B-Type		1SDA067132R1
XT4	XT4 RC Sel		1SDA067131R1
XT5	XT5 RC Sel ⁽¹⁾		1SDA105131R1
XT5	XT5 RC Sel "Alarm Only" ⁽¹⁾		1SDA105132R1

(1) This can also be mounted on a three-poles circuit-breaker

Panel type residual current delay



Panel type residual current delay - RCQ020/A

Size	Type	Code
XT1...XT7 M	RCQ020/A 115-230V AC	1SDA065979R1
XT1...XT7 M	RCQ020/A 415V AC	1SDA065980R1
XT1...XT7 M	RCQ020/P 110-690 V AC	1SDA069390R1
XT1...XT7 M	Toroid closed Ø 60mm	1SDA037394R1
XT1...XT7 M	Toroid closed Ø 110mm	1SDA037395R1
XT1...XT7 M	Toroid closed Ø 185mm	1SDA050543R1

Note: Opening coil and undervoltage coil to be ordered separately



Toroid

Ordering codes for accessories

Accessories for electronic Ekip LSI, Ekip LSIG and Ekip M-LRIU trip units

Ekip LSI, Ekip LSIG and Ekip M-LRIU trip units

Accessories for electronic Ekip Dip trip units (Ekip LSI, Ekip LSIG and Ekip M-LRIU)



Ekip Display

Size	Type	Fixed/Plug-in	Withdrawable
XT2-XT4	Ekip Display	1SDA068659R1	1SDA068659R1
XT2-XT4	Ekip LED Meter	1SDA068660R1	1SDA068660R1
XT2-XT4	Ekip Com for TM, Ekip LS/I, Ekip I, Ekip M-LIU, MCP and molded case switches	1SDA068661R1	1SDA068662R1
XT2-XT4	Ekip Com + Ekip Display for Ekip LSI, Ekip LSIG, Ekip E-LSIG	1SDA085535R1	1SDA085536R1
XT2-XT4	HMI030 interface on front of panel	1SDA063143R1	1SDA063143R1

Connection kits



Ekip LED Meter

Size	Type	Fixed/Plug-in	Withdrawable
XT2-XT4	Kit of 24V DC auxiliary voltage for electronic trip units	1SDA066980R1	1SDA066981R1
XT2-XT4	Kit for external neutral connection	1SDA066984R1	1SDA066985R1
XT4	Kit for external neutral voltage connection	1SDA069651R1	1SDA069652R1

Ordering codes for accessories

Accessories for electronic Ekip Touch trip units

Ekip Cartridge



Ekip Cartridge

Size	Type	Code
XT2-XT4-XT5	Ekip Cartridge 2 slots XT2-XT4-XT5	1SDA105203R1
XT2-XT4-XT5	Ekip Cartridge 4 slots XT2-XT4-XT5	1SDA105204R1

Power Supply modules



Ekip Supply

Size	Type	Code
XT2...XT5- XT7-XT7 M	Ekip Supply 110-240V AC/DC	1SDA074172R1
XT2...XT5- XT7-XT7 M	Ekip Supply 24-48V DC	1SDA074173R1

Connectivity Modules

Internal modules



Ekip COM

Size	Type	Fixed/Plug-in	Withdrawable
XT2-XT4	Ekip Com Ethernet	1SDA105173R1	1SDA105173R1
XT2-XT4	Ekip Com Hub	1SDA105160R1	1SDA105160R1
XT2-XT4	Ekip Com IEC61850	1SDA105174R1	1SDA105174R1
XT2-XT4	Ekip Com Modbus RTU	1SDA105175R1	1SDA105176R1
XT2-XT4	Ekip Com Modbus TCP	1SDA105177R1	1SDA105177R1
XT2-XT4	Ekip Com Profinet	1SDA105180R1	1SDA105180R1
XT2-XT4	Ekip Link	1SDA105197R1	1SDA105197R1
XT2-XT4	Ekip Com STA Modbus TCP	1SDA105183R1	1SDA105184R1
XT2-XT4	Ekip Com STA Modbus RTU	1SDA105181R1	1SDA105182R1
XT5	Ekip Com Ethernet	1SDA105185R1	1SDA105185R1
XT5	Ekip Com Hub	1SDA105161R1	1SDA105161R1
XT5	Ekip Com IEC61850	1SDA105186R1	1SDA105186R1
XT5	Ekip Com Modbus RTU	1SDA105187R1	1SDA105188R1
XT5	Ekip Com Modbus TCP	1SDA105189R1	1SDA105189R1
XT5	Ekip Com Profinet	1SDA105192R1	1SDA105192R1
XT5	Ekip Link	1SDA105198R1	1SDA105198R1
XT5	Ekip Com STA Modbus TCP	1SDA105195R1	1SDA105196R1
XT5	Ekip Com STA Modbus RTU	1SDA105193R1	1SDA105194R1
XT5	Ekip Com OPC UA	1SDA105190R1	1SDA105190R1
XT5	Ekip Com Open ADR	1SDA105191R1	1SDA105191R1



Ekip Link

Cartridge and XT7 modules

Size	Type	Code
XT2-XT4-XT5- XT7-XT7 M	Ekip Com Modbus RTU Tmax XT	1SDA105166R1
XT2-XT4-XT5- XT7-XT7 M	Ekip Com Modbus TCP Tmax XT	1SDA105167R1
XT2-XT4-XT5- XT7-XT7 M	Ekip Com Profibus Tmax XT	1SDA105170R1
XT2-XT4-XT5- XT7-XT7 M	Ekip Com Profinet Tmax XT	1SDA105171R1
XT2-XT4-XT5- XT7-XT7 M	Ekip Com Devicenet Tmax XT	1SDA105162R1
XT2-XT4-XT5- XT7-XT7 M	Ekip Com Ethernet/IP Tmax XT	1SDA105163R1
XT2-XT4-XT5- XT7-XT7 M	Ekip Com IEC61850 Tmax XT	1SDA105165R1
XT2-XT4-XT5- XT7-XT7 M	Ekip Link Tmax XT	1SDA105172R1
XT2-XT4-XT5- XT7-XT7 M	Ekip Com Hub Tmax XT	1SDA105164R1
XT2-XT4-XT5- XT7-XT7 M	Ekip Com R Modbus RTU	1SDA074157R1
XT2-XT4-XT5- XT7-XT7 M	Ekip Com R Modbus TCP	1SDA107402R1
XT2-XT4-XT5- XT7-XT7 M	Ekip Com R Profibus	1SDA074159R1
XT2-XT4-XT5- XT7-XT7 M	Ekip Com R Profinet	1SDA107403R1
XT2-XT4-XT5- XT7-XT7 M	Ekip Com R DeviceNet™	1SDA074161R1
XT2-XT4-XT5- XT7-XT7 M	Ekip Com R EtherNet/IP™	1SDA107404R1
XT2-XT4-XT5- XT7-XT7 M	Ekip Com R IEC61850	1SDA107405R1
XT7 M	Ekip Com Actuator	1SDA074166R1

Ordering codes for accessories

Accessories for electronic Ekip Touch trip units

Signaling Modules



Ekip 2K Signalling



Ekip 10K Signalling

Internal modules

Size	Type	Code	
XT5	EKIP Signalling 1K-1 XT5 INT	1SDA105201R1	1SDA105202R1

Cartridge and XT7 modules

Size	Type	Code	
XT2-XT4-XT5- XT7-XT7 M	Ekip Signalling 2K-1	1SDA074167R1	
XT2-XT4-XT5- XT7-XT7 M	Ekip Signalling 2K-2	1SDA074168R1	
XT2-XT4-XT5- XT7-XT7 M	Ekip Signalling 2K-3	1SDA074169R1	
XT2-XT4-XT5- XT7-XT7 M	Ekip Signalling 3T-1 AI - Temp PT1000	1SDA085693R1	
XT2-XT4-XT5- XT7-XT7 M	Ekip Signalling 3T-2 AI - Temp PT1000	1SDA085694R1	
XT2-XT4-XT5- XT7-XT7 M	Ekip Signalling 10K*	1SDA074171R1	

*External device

Other modules

Measuring modules

Size	Type	Code	
XT7-XT7 M	Ekip Measuring module	1SDA105210R1	
XT7-XT7 M	Voltage socket for neutral on right side L1 L2 L3 N	1SDA076244R1	



Ekip Measuring

Internal Maintenance module

Size	Type	Code	
XT5	EKIP Maintenance Module XT5 INT	1SDA105199R1	1SDA105200R1



Ekip Maintenance

Synchrocheck module

Size	Type	Code	
XT2-XT4-XT5- XT7-XT7 M	Ekip Synchrocheck	1SDA074183R1	

Contactor interface module

Size	Type	Code
XT2-XT4-XT5- XT7-XT7 M	Ekip CI	1SDA105205R1

External 3T signaling probe module

Size	Type	Code
XT2-XT4-XT5- XT7-XT7 M	External probe PT1000 3mt	1SDA085695R1

Options for Ekip electrical trip units

Size	Type	Code
XT7-XT7 M	Upper internal installed voltage outlets	1SDA074216R1
XT7-XT7 M	External installed voltage outlets	1SDA074217R1
XT7-XT7 M	Arrangement for cables with lower internal voltage outlets	1SDA074213R1
XT7-XT7 M	Arrangement for cables with upper internal voltage outlets	1SDA074214R1
XT7-XT7 M	Arrangement for cables with external voltage outlets	1SDA074215R1
XT7-XT7 M	RTC Ekip 24V	1SDA073772R1
XT7-XT7 M	AUP Ekip auxiliary position contact	1SDA073768R1



Ekip RTC contacts

Connection kits

Size	Type	Fixed/Plug-in	Withdrawable
XT2-XT4	Con.Kit 24V/IntBus/ExtNeut/Sel	1SDA101979R1	1SDA105206R1
XT2-XT4	Kit for external neutral voltage connection	1SDA101978R1	
XT2-XT4	Kit zone selectivity XT2 XT4 Ekip Touch	1SDA113126R1	
XT2-XT4-XT5	Terminal block din rails with 5 positions	1SDA101976R1	1SDA101976R1
XT2-XT4-XT5	Terminal block din rails with 10 positions	1SDA101977R1	1SDA101977R1
XT5	Connection kit 24Vdc/Internal Bus XT5 W		1SDA105207R1
XT5	Kit zone selectivity XT5 Ekip Touch	1SDA113125R1	1SDA107397R1
XT5	Kit external neutral volt. conn XT5	1SDA107391R1	1SDA107391R1
XT5	Kit for external neutral volt.conn XT5		1SDA107392R1
XT5	Kit Ext NE sensor XT5 Ekip Dip	1SDA107396R1	1SDA107396R1
XT5	Kit Ext NE V sensor XT5 Ekip Touch	1SDA107395R1	1SDA107395R1
XT5	Kit Ext NE C sensor XT5 Ekip Touch	1SDA107394R1	1SDA107394R1
XT5	Kit Ext NE C+V sensor XT5 Ekip Touch	1SDA107393R1	1SDA107393R1

Ordering codes for accessories

Accessories for electronic Ekip Touch trip units

Advanced functionality

Packages

Size	Type	Code
XT2-XT4	Measuring package for XT2-XT4	1SDA105208R1
XT2-XT4	Adaptive protection for XT2-XT4	1SDA105221R1
XT2-XT4	Frequency protection for XT2-XT4	1SDA105215R1
XT2-XT4	Power protection for XT2-XT4	1SDA105217R1
XT2-XT4	ROCOF protection for XT2-XT4	1SDA105219R1
XT2-XT4	Advanced voltages protection for XT2-XT4	1SDA105213R1
XT2-XT4	Voltages protection for XT2-XT4	1SDA105211R1
XT5-XT7-XT7 M	Datalogger for XT5-XT7	1SDA105224R1
XT5-XT7-XT7 M	Network analyzer for XT5-XT7	1SDA105226R1
XT5-XT7-XT7 M	Measuring package for XT5-XT7	1SDA105209R1
XT5-XT7-XT7 M	Adaptive protection for XT5-XT7	1SDA105222R1
XT5-XT7-XT7 M	Frequency protection for XT5-XT7	1SDA105216R1
XT5-XT7-XT7 M	Power protection for XT5-XT7	1SDA105218R1
XT5-XT7-XT7 M	ROCOF protection for XT5-XT7	1SDA105220R1
XT5-XT7-XT7 M	Advanced voltages protection for XT5-XT7	1SDA105214R1
XT5-XT7-XT7 M	Voltages protection for XT5-XT7	1SDA105212R1

Solutions

Size	Type	Code
XT2-XT4-XT5-XT7-XT7 M	IPS - Interface protection	1SDA082919R1
XT2-XT4-XT5-XT7-XT7 M	Load shedding - adaptive	1SDA082921R1
XT2-XT4-XT5-XT7-XT7 M	Load shedding - predictive	1SDA082922R1
XT2-XT4-XT5-XT7-XT7 M	Synchro reclosing	1SDA082923R1
XT2-XT4-XT5-XT7-XT7 M	ATS License main-tie-main closed	1SDA082886R1
XT2-XT4-XT5-XT7-XT7 M	ATS License main-main closed	1SDA082888R1
XT2-XT4-XT5-XT7-XT7 M	ATS License main-tie-main open	1SDA082887R1
XT2-XT4-XT5-XT7-XT7 M	ATS License main-main open	1SDA082889R1
XT2-XT4-XT5-XT7-XT7 M	Ekip Power controller	1SDA074212R1

Metering functionality

Size	Type	Code
XT2-XT4	Class 1 Power & Energy Metering ⁽¹⁾	1SDA107492R1
XT5-XT7	Class 1 Power & Energy Metering ⁽¹⁾	1SDA107493R1

(1) Factory mounted only

Display and supervision systems**Display and supervision systems**

Size	Type	Code
XT2-XT4-XT5-XT7-XT7 M	Ekip Programming	1SDA076154R1
XT2-XT4-XT5-XT7-XT7 M	Ekip Multimeter display on front of switchboard	1SDA074192R1
XT2-XT4-XT5-XT7-XT7 M	Ekip Control panel for 10 circuit-breakers	1SDA074311R1
XT2-XT4-XT5-XT7-XT7 M	Ekip Control panel for 30 circuit-breakers	1SDA074312R1
XT2-XT4-XT5-XT7-XT7 M	Ekip View software for 30 circuit-breakers	1SDA074298R1
XT2-XT4-XT5-XT7-XT7 M	Ekip View software for 60 circuit-breakers	1SDA074299R1
XT2-XT4-XT5-XT7-XT7 M	Ekip View software for unlimited circuit-breakers	1SDA074300R1



Ekip Multimeter Display

Ordering codes for accessories

Other accessories for trip units

Test and configuration

Test and configuration

Size	Type	Code
XT2-XT4-XT5- XT6-XT7-XT7 M	Ekip TT - Trip test unit	1SDA066988R1
XT2-XT4-XT5- XT6-XT7-XT7 M	Ekip T&P - Programming and test unit	1SDA066989R1
XT2-XT4-XT5- XT6-XT7-XT7 M	Ekip Bluetooth key	1SDA101980R1

Current sensor

Current sensor for neutral conductor outside the circuit-breaker

Size	Type	Code
XT2	CT External neutral 10A Ekip Dip	1SDA067211R1
XT2	CT External neutral 25A Ekip Dip	1SDA067212R1
XT2	CT External neutral 60A Ekip Dip	1SDA081983R1
XT2	CT External neutral 100A Ekip Dip	1SDA069143R1
XT2	CT External neutral 125A Ekip Dip	1SDA081984R1
XT2	CS External neutral $I_n \leq 60A$ Ekip Touch	1SDA101971R1
XT2	CS External neutral $I_n \geq 100A$ Ekip Touch	1SDA101972R1
XT2	CS External neutral $I_n \leq 60A$ Ekip Touch with voltage	1SDA107406R1
XT2	CS External neutral $I_n \geq 100A$ Ekip Touch with voltage	1SDA107407R1
XT4	CT External neutral 40A Ekip Dip	1SDA066975R1
XT4	CT External neutral 60A Ekip Dip	1SDA081985R1
XT4	CT External neutral 100A Ekip Dip	1SDA066977R1
XT4	CT External neutral 150A Ekip Dip	1SDA081986R1
XT4	CT External neutral 225A Ekip Dip	1SDA081987R1
XT4	CT External neutral 250A Ekip Dip	1SDA066979R1
XT4	CS External neutral Ekip Touch	1SDA101973R1
XT4	CS External neutral Ekip Touch with voltage	1SDA107408R1
XT5	CT External neutral 250A Ekip Dip	1SDA101966R1
XT5	CT External neutral 300A Ekip Dip	1SDA105152R1
XT5	CT External neutral 400A Ekip Dip	1SDA105154R1
XT5	CT External neutral 600A Ekip Dip	1SDA105155R1
XT5	CS External neutral Ekip Touch	1SDA101974R1
XT5	CS External neutral voltage Ekip Touch	1SDA107409R1
XT6	CT External neutral 600A Ekip Dip	1SDA107671R1
XT6	CT External neutral 800A Ekip Dip	1SDA105158R1
XT6	CT External neutral 1000A Ekip Dip	1SDA105159R1
XT7-XT7M	CS External neutral up to 1200A	1SDA082134R1



Current sensor

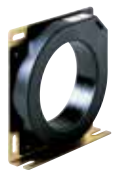

Homopolar sensor



Toroid RC

Homopolar toroid for the earthing conductor of the main power supply

Size	Type	Code
XT7-XT7 M	Homopolar toroid 100A	1SDA073743R1
XT7-XT7 M	Homopolar toroid 250A	1SDA076248R1
XT7-XT7 M	Homopolar toroid 400A	1SDA076249R1
XT7-XT7 M	Homopolar toroid 800A	1SDA076250R1
XT7-XT7 M	Toroid RC 3p	1SDA073741R1

Rating plug for Ekip trip units



Rating plug

Rating plug

Size	Type	Loose supply	Installed
XT5	Rating Plug In=250A	1SDA101992R1	
XT5	Rating Plug In=300A	1SDA101993R1	
XT5	Rating Plug In=400A	1SDA101996R1	
XT5	Rating Plug In=500A	1SDA101998R1	
XT5	Rating Plug In=600A	1SDA101999R1	
Ekip Dip LS/I, Ekip Dip LIG, Ekip M Dip I, Ekip G Dip LS/I -BASIC Trip Units			
XT7-XT7 M	Rating Plug In = 600 A XT7-XT7 M	1SDA107618R1	1SDA107624R1
XT7-XT7 M	Rating Plug In = 800 A XT7-XT7 M	1SDA102012R1	1SDA102013R1
XT7-XT7 M	Rating Plug In = 1000 A XT7-XT7 M	1SDA102015R1	1SDA102016R1
XT7-XT7 M	Rating Plug In = 1200 A XT7-XT7 M	1SDA102017R1	
Ekip Dip LSI, Ekip Dip LSIG, Ekip Touch all			
XT7-XT7 M	Rating Plug In = 600 A XT7-XT7 M	1SDA107620R1	1SDA107622R1
XT7-XT7 M	Rating Plug In = 800 A XT7-XT7 M	1SDA102002R1	1SDA102003R1
XT7-XT7 M	Rating Plug In = 1000 A XT7-XT7 M	1SDA102005R1	1SDA102006R1
XT7-XT7 M	Rating Plug In = 1200 A XT7-XT7 M	1SDA102007R1	



—

ABB SACE S.p.A.

Electrification business

Smart Power business line

5, Via Pescaria

I-24123 Bergamo - Italy

Phone: +39 035 395.111

go.abb/xt



Stay tuned. Discover more by visiting the webpage reserved to SACE Tmax XT and be always up-to-date with the latest edition of the catalogue.